

Features

- Ultra High Efficiency (Up to 95.0%)
- Full Power at Wide Output Current Range (Constant Power)
- Thermal Sensing and Protection for LED Module
- 0-10V/PWM/3-Timer-Modes Dimmable
- Dim-to-Off with Standby Power ≤ 1.5 W
- Output Lumen Compensation
- Input Surge Protection: DM 6kV, CM 10kV
- All-Around Protection: OVP, SCP, OTP
- IP67 and UL Dry / Damp / Wet Location
- SELV Output
- TYPE HL, for use in a Class I, Division 2 hazardous (Classified) location
- 5 Years Warranty



Description

The ESD-600SxxxDT series is a 600W, constant-current, programmable LED driver that operates from 249-528 Vac input with excellent power factor. Created for many lighting applications including high mast, sports, aquaculture and horticulture, etc, it provides a dim-to-off mode with low standby power. The high efficiency of these drivers and compact metal case enables them to run cooler, significantly improving reliability and extending product life. To ensure trouble-free operation, protection is provided against input surge, input over voltage, output over voltage, short circuit, and over temperature.

Models

Adjustable Output Current Range	Full-Power Current Range(1)	Default Output Current	Input Voltage Range(2)	Output Voltage Range	Max. Output Power	Typical Efficiency (3)	Power Factor		Model Number
							277Vac	480Vac	
0.136-1.70A	1.36-1.70A	1.7A	249-528Vac 352-500Vdc	176 ~ 441Vdc	600 W	95.0%	0.96	0.95	ESD-600S170DT
0.168-2.10A	1.68-2.10A	2.1A	249-528Vac 352-500Vdc	143 ~ 357Vdc	600 W	95.0%	0.96	0.95	ESD-600S210DT
0.224-2.80A	2.24-2.80A	2.8 A	249-528Vac 352-500Vdc	108 ~ 268Vdc	600 W	94.5%	0.96	0.95	ESD-600S280DT
0.336-4.20A	3.36-4.20A	4.2 A	249-528Vac 352-500Vdc	72 ~ 178Vdc	600 W	95.0%	0.96	0.95	ESD-600S420DT
0.448-5.60A	4.48-5.60A	5.6 A	249-528Vac 352-500Vdc	54 ~ 134Vdc	600 W	95.0%	0.96	0.95	ESD-600S560DT
0.592-7.40A	5.92-7.40A	7.0 A	249-528Vac 352-500Vdc	41 ~ 101Vdc	600 W	94.5%	0.96	0.95	ESD-600S740DT ⁽⁴⁾
0.784-9.80A	7.84-9.80A	9.8 A	249-528Vac 352-500Vdc	31 ~ 76Vdc	600 W	94.0%	0.96	0.95	ESD-600S980DT ⁽⁴⁾
1.0 - 12.5 A	10 - 12.5 A	12.5 A	249-528Vac 352-500Vdc	24 ~ 60Vdc	600 W	94.0%	0.96	0.95	ESD-600S12ADT ⁽⁴⁾

- Notes:** (1) Output current range with constant power at 600W.
 (2) Certified voltage range: 277-480Vac or 352-500Vdc.
 (3) Measured at 100% load and 480Vac input (see below "General Specifications" for details).
 (4) SELV output.

I-V Operating Area

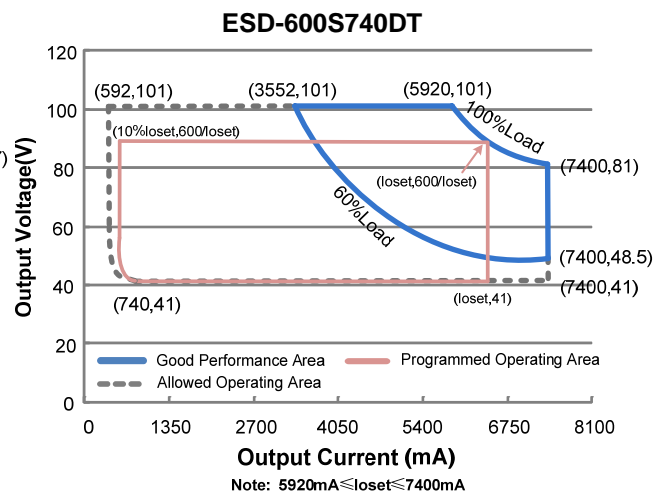
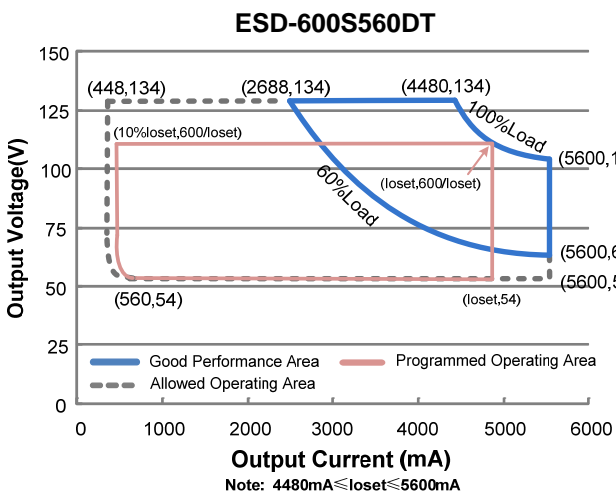
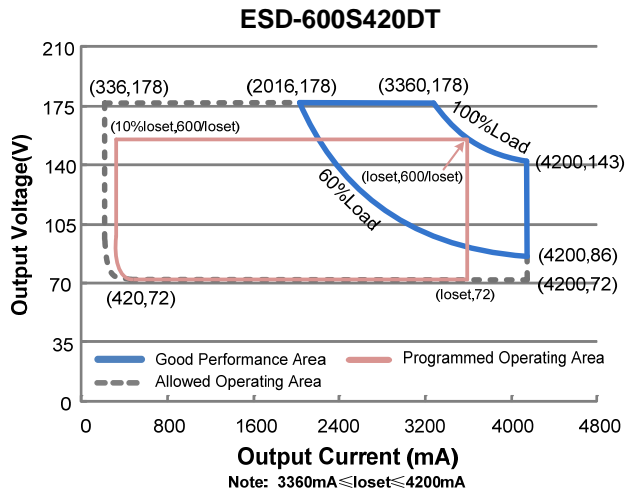
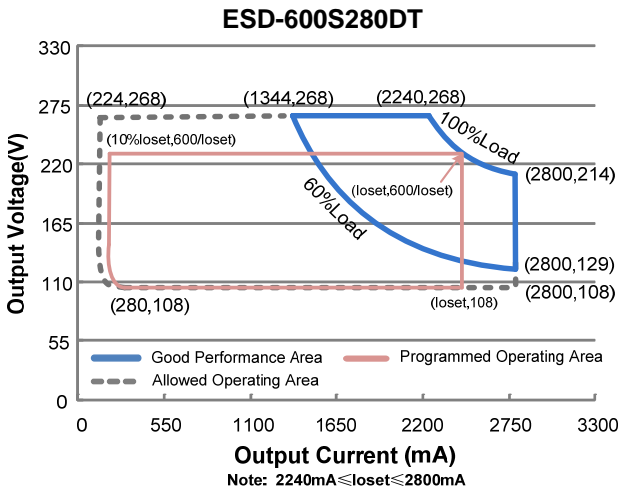
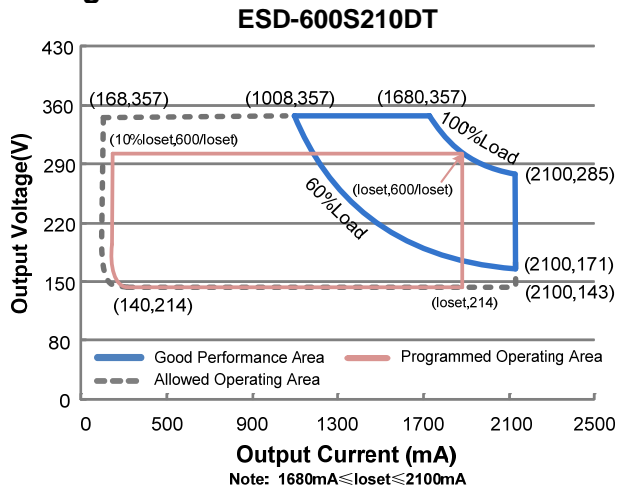
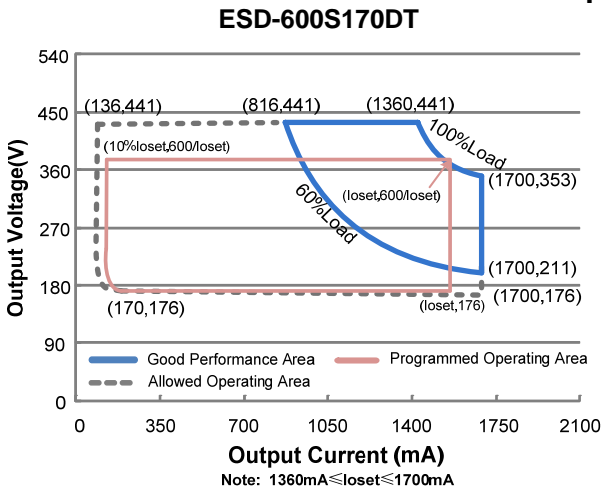

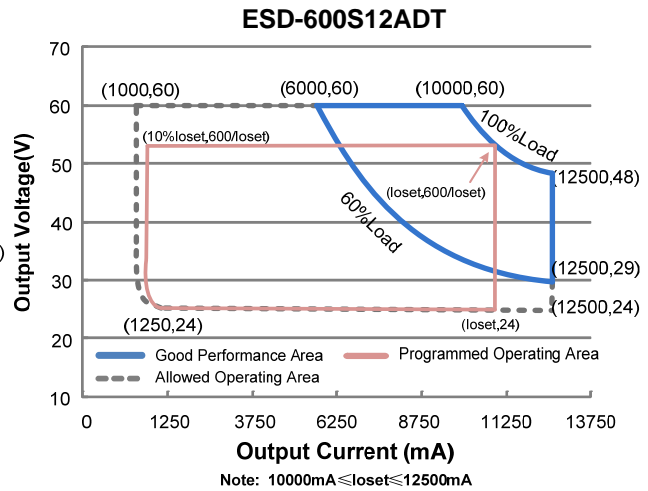
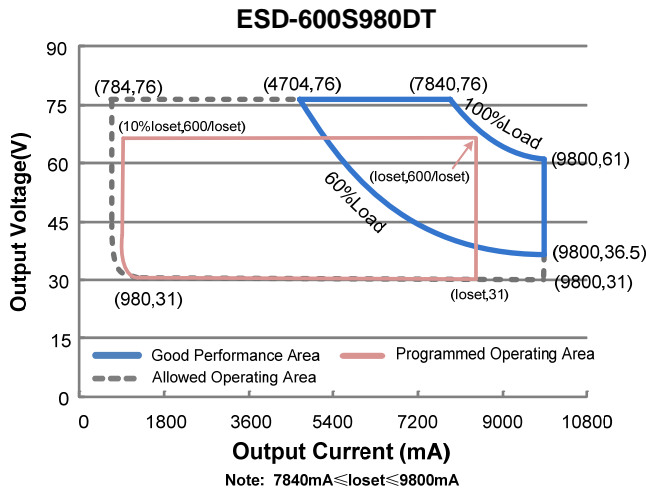

Input Specifications

Parameter	Min.	Typ.	Max.	Notes
Input Voltage	249 Vac	-	528 Vac	325-500Vdc
Input Frequency	47 Hz	-	63 Hz	
Leakage Current	-	-	0.75 MIU	UL8750; 480Vac/ 60Hz, Grounding effectively
	-	-	0.70 mA	IEC60598-1; 480Vac/ 60Hz, Grounding effectively
Input AC Current	-	-	2.50 A	Measured at 100% load and 277 Vac input.
	-	-	1.45 A	Measured at 100% load and 480 Vac input.
Inrush Current(I ² t)	-	-	20.4 A ² s	At 480Vac input, 25°C cold start, duration=869 μs, 10%Ipk-10%Ipk. See Inrush Current Waveform for the details.
PF	0.90	-	-	At 277-480Vac, 50-60Hz, 60%-100% Load (360 - 600W)
THD	-	-	20%	

Output Specifications

Parameter	Min.	Typ.	Max.	Notes
Output Current Tolerance	-5%Iloadset	-	5%Iloadset	100% load
Output Current Setting(Iloadset) Range				
ESD-600S170DT	136 mA	-	1700 mA	
ESD-600S210DT	168 mA	-	2100 mA	
ESD-600S280DT	224 mA	-	2800 mA	
ESD-600S420DT	336 mA	-	4200 mA	
ESD-600S560DT	448 mA	-	5600 mA	
ESD-600S740DT	592 mA	-	7400 mA	
ESD-600S980DT	784 mA	-	9800 mA	
ESD-600S12ADT	1000 mA	-	12500 mA	

Output Specifications

Parameter	Min.	Typ.	Max.	Notes
Output Current Setting Range with Constant Power				
ESD-600S170DT	1360 mA	-	1700 mA	
ESD-600S210DT	1680 mA	-	2100 mA	
ESD-600S280DT	2240 mA	-	2800 mA	
ESD-600S420DT	3360 mA	-	4200 mA	
ESD-600S560DT	4480 mA	-	5600 mA	
ESD-600S740DT	5920 mA	-	7400 mA	
ESD-600S980DT	7840 mA	-	9800 mA	
ESD-600S12ADT	10000 mA	-	12500 mA	
Total Output Current Ripple (pk-pk)	-	5%Iomax	10%Iomax	100% load, 20 MHz BW
Output Current Ripple at < 200 Hz (pk-pk)	-	2%Iomax	-	100% load
Startup Overshoot Current	-	-	10%Iomax	100% load
No Load Output Voltage				
ESD-600S170DT	-	-	480 V	
ESD-600S210DT	-	-	390 V	
ESD-600S280DT	-	-	290 V	
ESD-600S420DT	-	-	198 V	
ESD-600S560DT	-	-	153 V	
ESD-600S740DT	-	-	110 V	
ESD-600S980DT	-	-	85 V	
ESD-600S12ADT	-	-	70 V	
Line Regulation	-	-	±0.5%	100% load
Load Regulation	-	-	±1.5%	
Turn-on Delay Time	-	-	0.75 s	Measured at 277-480Vac input, 60%-100% Load
Temperature Coefficient of I _{oSet}	-	0.03%/°C	-	Case temperature = 0°C ~T _c max
12V Auxiliary Output Voltage	10.8 V	12 V	13.2 V	
12V Auxiliary Output Source Current	0 mA	-	200 mA	Return terminal is "Dim"

Note: All specifications are typical at 25°C unless otherwise stated.

General Specifications

Parameter	Min.	Typ.	Max.	Notes	
Efficiency at 277 Vac input:					
ESD-600S170DT					
I _o = 1360 mA	92.0%	94.0%	-		
I _o = 1700 mA	92.0%	94.0%	-		
ESD-600S210DT					
I _o = 1680 mA	92.0%	94.0%	-		
I _o = 2100 mA	91.5%	93.5%	-		
ESD-600S280DT					
I _o = 2240 mA	91.5%	93.5%	-		
I _o = 2800 mA	91.0%	93.0%	-		
ESD-600S420DT					
I _o = 3360 mA	92.0%	94.0%	-	Measured at 100% load and steady-state temperature in 25°C ambient; (Efficiency will be about 2.0% lower if measured immediately after startup.)	
I _o = 4200 mA	91.5%	93.5%	-		
ESD-600S560DT					
I _o = 4480 mA	92.0%	94.0%	-		
I _o = 5600 mA	91.5%	93.5%	-		
ESD-600S740DT					
I _o = 5920 mA	91.5%	93.5%	-		
I _o = 7400 mA	90.5%	92.5%	-		
ESD-600S980DT					
I _o = 7840 mA	90.5%	92.5%	-		
I _o = 9800 mA	89.5%	91.5%	-		
ESD-600S12ADT					
I _o =10000 mA	91.0%	93.0%	-		
I _o =12500 mA	90.0%	92.0%	-		
Efficiency at 347 Vac input:					
ESD-600S170DT					
I _o = 1360 mA	92.5%	94.5%	-		
I _o = 1700 mA	92.5%	94.5%	-		
ESD-600S210DT					
I _o = 1680 mA	93.0%	95.0%	-		
I _o = 2100 mA	92.0%	94.0%	-		
ESD-600S280DT					
I _o = 2240 mA	92.0%	94.0%	-		
I _o = 2800 mA	91.5%	93.5%	-		
ESD-600S420DT					
I _o = 3360 mA	92.5%	94.5%	-	Measured at 100% load and steady-state temperature in 25°C ambient; (Efficiency will be about 2.0% lower if measured immediately after startup.)	
I _o = 4200 mA	92.0%	94.0%	-		
ESD-600S560DT					
I _o = 4480 mA	92.5%	94.5%	-		
I _o = 5600 mA	92.0%	94.0%	-		
ESD-600S740DT					
I _o = 5920 mA	92.0%	94.0%	-		
I _o = 7400 mA	91.0%	93.0%	-		
ESD-600S980DT					
I _o = 7840 mA	91.0%	93.0%	-		
I _o = 9800 mA	90.5%	92.5%	-		
ESD-600S12ADT					
I _o =10000 mA	91.5%	93.5%	-		
I _o =12500 mA	90.5%	92.5%	-		

General Specifications (Continued)

Parameter	Min.	Typ.	Max.	Notes	
Efficiency at 480 Vac input: ESD-600S170DT I _o = 1360 mA I _o = 1700 mA	93.0% 93.0%	95.0% 95.0%	- -	Measured at 100% load and steady-state temperature in 25°C ambient; (Efficiency will be about 2.0% lower if measured immediately after startup.)	
ESD-600S210DT I _o = 1680 mA I _o = 2100 mA	93.0% 92.5%	95.0% 94.5%	- -		
ESD-600S280DT I _o = 2240 mA I _o = 2800 mA	92.5% 92.0%	94.5% 94.0%	- -		
ESD-600S420DT I _o = 3360 mA I _o = 4200 mA	93.0% 92.5%	95.0% 94.5%	- -		
ESD-600S560DT I _o = 4480 mA I _o = 5600 mA	93.0% 92.5%	95.0% 94.5%	- -		
ESD-600S740DT I _o = 5920 mA I _o = 7400 mA	92.5% 91.5%	94.5% 93.5%	- -		
ESD-600S980DT I _o = 7840 mA I _o = 9800 mA	92.0% 91.0%	94.0% 93.0%	- -		
ESD-600S12ADT I _o =10000 mA I _o =12500 mA	92.0% 91.0%	94.0% 93.0%	- -		
Standby power	-	-	1.5 W		Measured at 480Vac/50Hz; Dimming off
MTBF	-	200,000 Hours	-		Measured at 480Vac input, 80%Load and 25°C ambient temperature (MIL-HDBK-217F)
Lifetime	-	101,000 Hours	-		Measured at 480Vac input, 80%Load and 70°C case temperature; See lifetime vs. T _c curve for the details
Operating Case Temperature for Safety T _{c_s}	-40°C	-	+89°C		
Operating Case Temperature for Warranty T _{c_w}	-40°C	-	+75°C		Case temperature for 5 years warranty
Storage Temperature	-40°C	-	+85°C		Humidity: 5%RH to 100%RH
Dimensions Inches (L × W × H) Millimeters (L × W × H)	9.84 × 5.67 × 1.91 250 × 144 × 48.5			With mounting ear 10.87 × 5.67 × 1.91 276 × 144 × 48.5	
Net Weight	-	3330 g	-		

Note: All specifications are typical at 25°C unless otherwise stated.

Dimming Specifications

Parameter	Min.	Typ.	Max.	Notes
Absolute Maximum Voltage on the V _{dim} (+) Pin	-20 V	-	20 V	
Source Current on V _{dim} (+)Pin	200 μA	300 μA	450 μA	V _{dim} (+) = 0 V

Dimming Specifications (Continued)

Parameter		Min.	Typ.	Max.	Notes
Dimming Output Range	ESD-600S170DT ESD-600S210DT ESD-600S280DT ESD-600S420DT ESD-600S560DT ESD-600S740DT ESD-600S980DT ESD-600S12ADT	10%loset	-	loset	1360mA ≤ loset ≤ 1700mA 1680mA ≤ loset ≤ 2100mA 2240 mA ≤ loset ≤ 2800 mA 3360mA ≤ loset ≤ 4200mA 4480mA ≤ loset ≤ 5600mA 5920 mA ≤ loset ≤ 7400 mA 7840 mA ≤ loset ≤ 9800 mA 10000 mA ≤ loset ≤ 12500 mA
	ESD-600S170DT ESD-600S210DT ESD-600S280DT ESD-600S420DT ESD-600S560DT ESD-600S740DT ESD-600S980DT ESD-600S12ADT	136 mA 168 mA 224 mA 336 mA 448 mA 592 mA 784 mA 1000 mA	-	loset	136mA ≤ loset < 1360mA 168mA ≤ loset < 1680mA 224 mA ≤ loset < 2240 mA 336mA ≤ loset < 3360mA 448mA ≤ loset < 4480mA 592 mA ≤ loset < 5920 mA 784 mA ≤ loset < 7840 mA 1000 mA ≤ loset < 10000 mA
Recommended Dimming Input Range		0 V	-	10 V	Default 0-10V dimming mode.
Dim off Voltage		0.35 V	0.5 V	0.65 V	
Dim on Voltage		0.55 V	0.7 V	0.85 V	
Hysteresis		-	0.2 V	-	
PWM_in High Level		3 V	-	10 V	Dimming mode set to PWM in PC interface.
PWM_in Low Level		-0.3 V	-	0.6 V	
PWM_in Frequency Range		200 Hz	-	3 KHz	
PWM_in Duty Cycle		1%	-	99%	
PWM Dimming off (Positive Logic)		3%	5%	8%	
PWM Dimming on (Positive Logic)		5%	7%	10%	
PWM Dimming off (Negative Logic)		92%	95%	97%	
PWM Dimming on (Negative Logic)		90%	93%	95%	
Hysteresis		-	2%	-	

Note: All specifications are typical at 25 °C unless stated otherwise.

Safety & EMC Compliance

Safety Category	Standard
UL/CUL	UL8750,CAN/CSA-C22.2 No. 250.13
CE	EN 61347-1, EN61347-2-13
EMI Standards	Notes
EN 55015 ⁽¹⁾	Conducted emission Test & Radiated emission Test

Safety & EMC Compliance (Continued)

EMI Standards	Notes
EN 61000-3-2	Harmonic current emissions
EN 61000-3-3	Voltage fluctuations & flicker
FCC Part 15 ⁽¹⁾	ANSI C63.4 Class B
	This device complies with Part 15 of the FCC Rules. Operation is subject to the following two conditions: [1] this device may not cause harmful interference, and [2] this device must accept any interference received, including interference that may cause undesired Operation.
EMS Standards	Notes
EN 61000-4-2	Electrostatic Discharge (ESD): 8 kV air discharge, 4 kV contact discharge
EN 61000-4-3	Radio-Frequency Electromagnetic Field Susceptibility Test-RS
EN 61000-4-4	Electrical Fast Transient / Burst-EFT
EN 61000-4-5	Surge Immunity Test: AC Power Line: Differential Mode 6 kV, Common Mode 10 kV ⁽²⁾
EN 61000-4-6	Conducted Radio Frequency Disturbances Test-CS
EN 61000-4-8	Power Frequency Magnetic Field Test
EN 61000-4-11	Voltage Dips
EN 61547	Electromagnetic Immunity Requirements Applies To Lighting Equipment

Note: (1) This LED driver meets the EMI specifications above, but EMI performance of a luminaire that contains it depends also on the other devices connected to the driver and on the fixture itself.

(2) To perform electric strength (hi-pot) testing, the “GDT ground disconnect” (nut and metal lock sheet) on the driver end-cap should be removed temporarily to prevent the internal gas discharge tube from conducting (as allowed by IEC 60598-1 Clause 10.2). After testing is completed, these items must be reinstalled to restore line-to-earth surge protection and secure the end cap.

Lifetime vs. Case Temperature

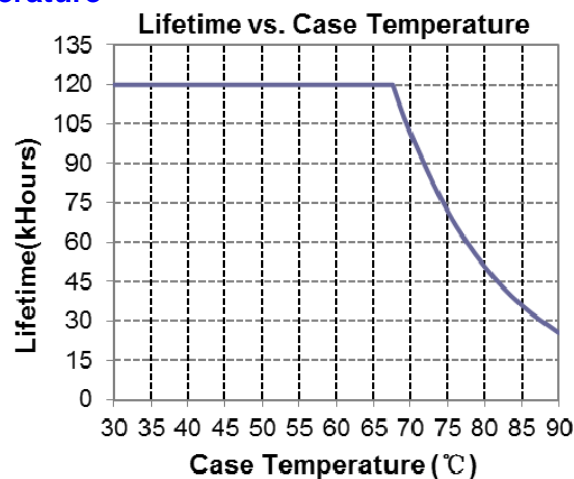

Inrush Current Waveform

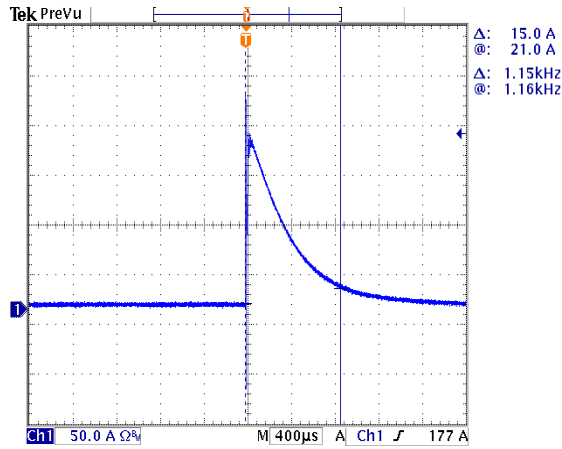

Efficiency vs. Load

ESD-600S170DT (Io=1360mA)

Efficiency vs. Output Voltage

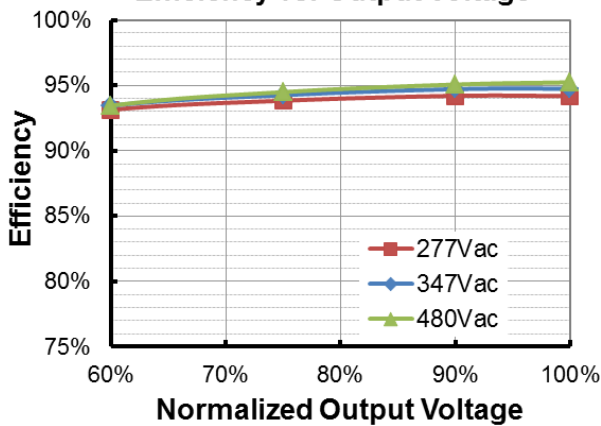

ESD-600S170DT (Io=1700mA)

Efficiency vs. Output Voltage

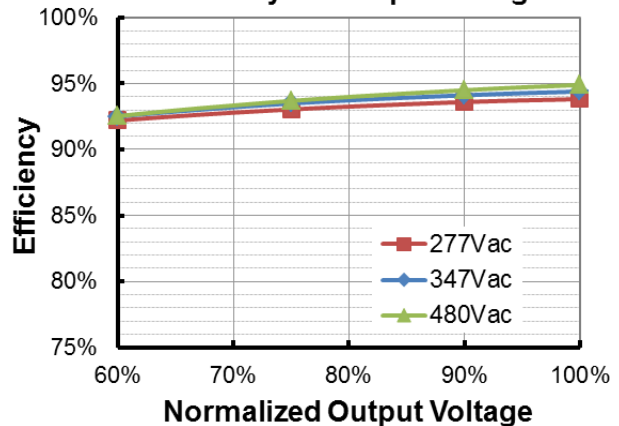

ESD-600S210DT (Io=1680mA)

Efficiency vs. Output Voltage

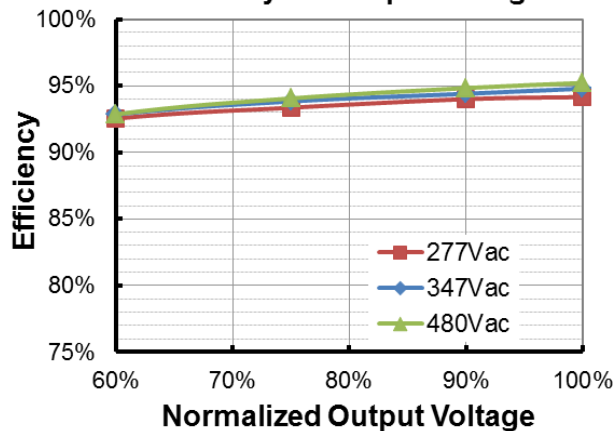

ESD-600S210DT (Io=2100mA)

Efficiency vs. Output Voltage

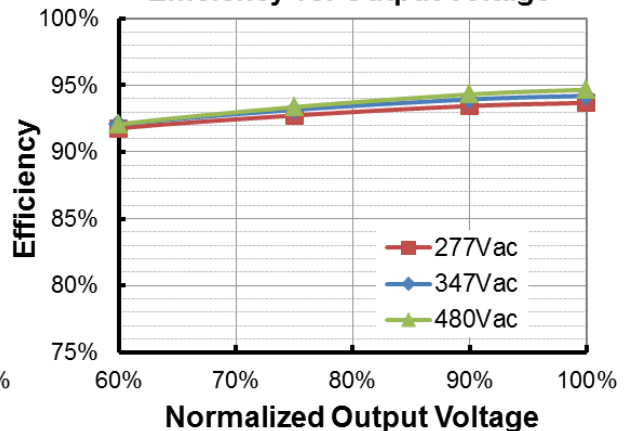

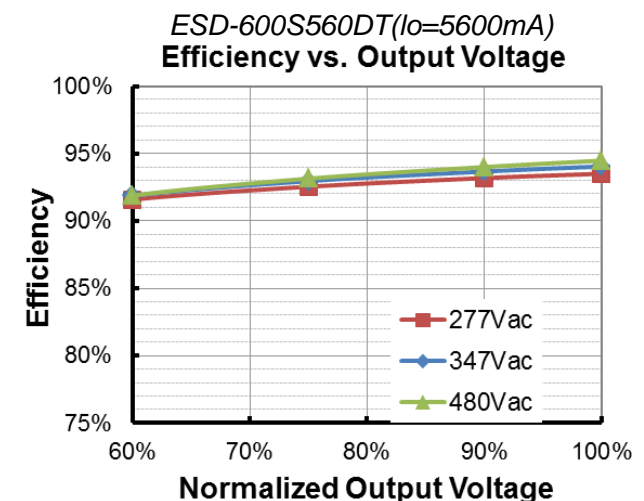
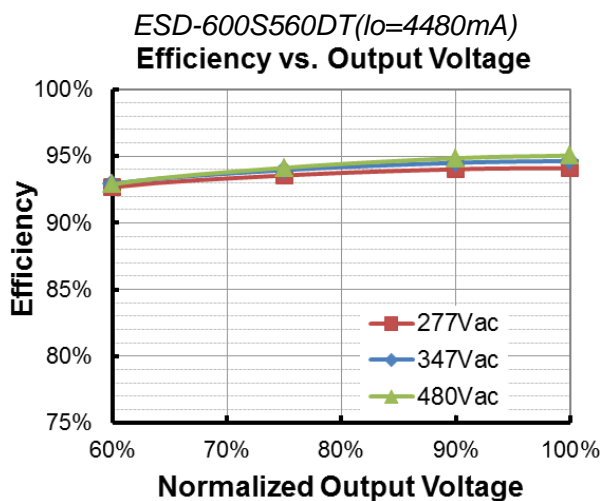
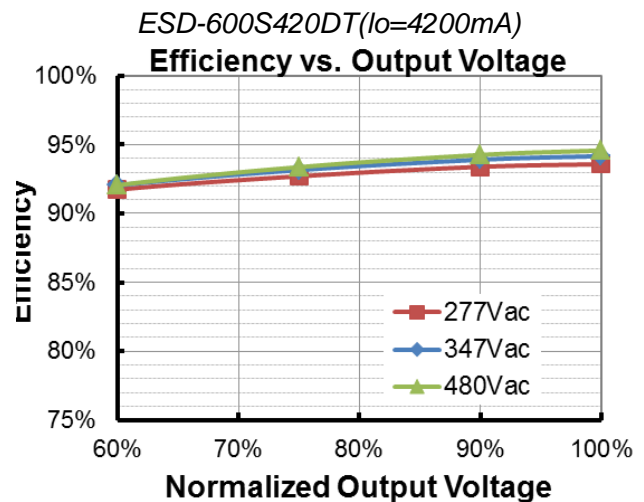
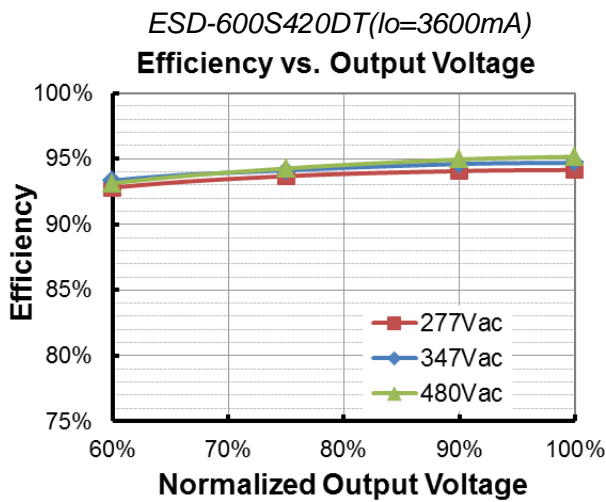
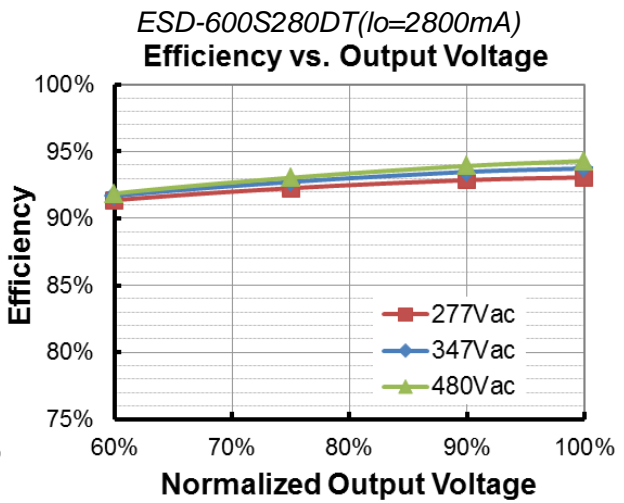
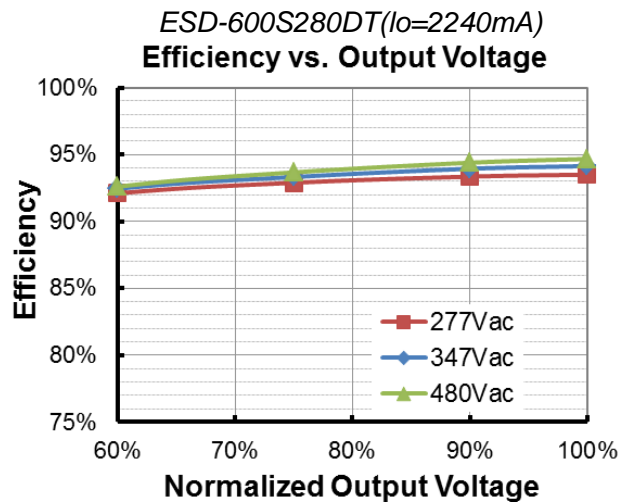

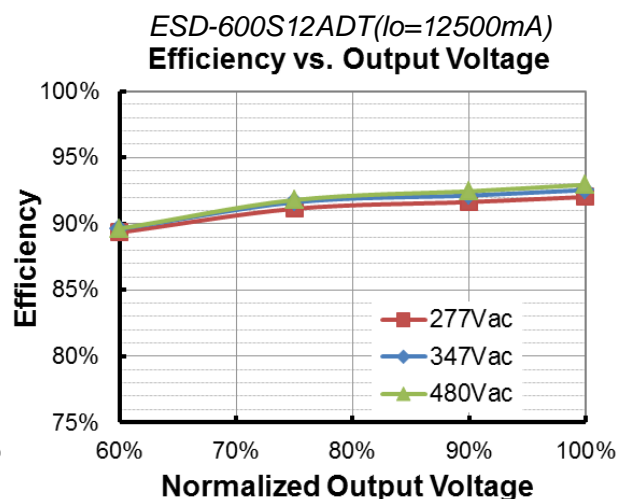
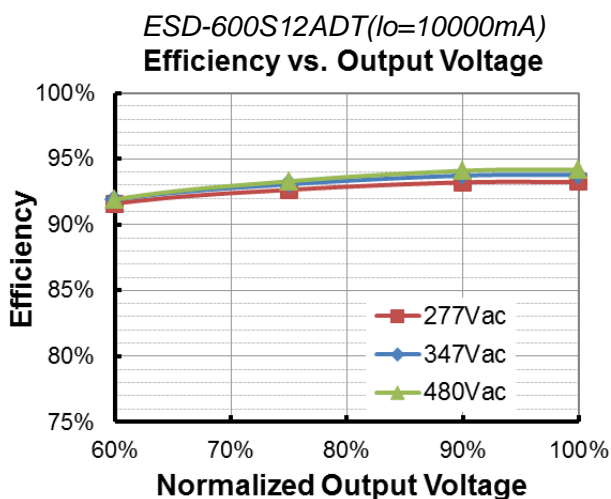
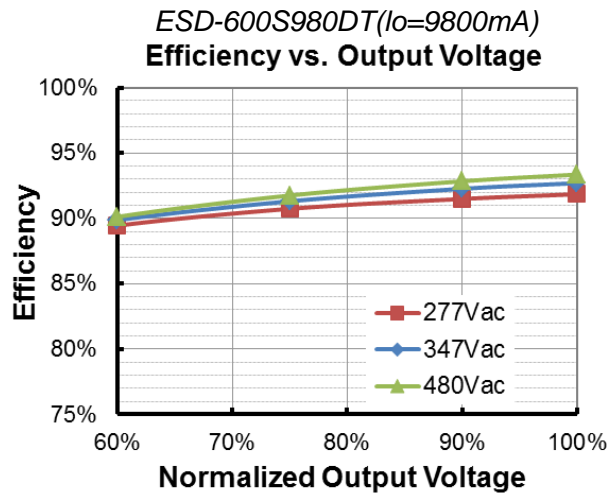
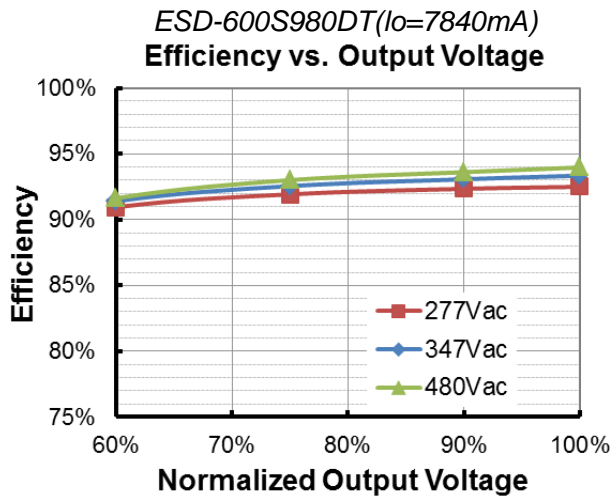
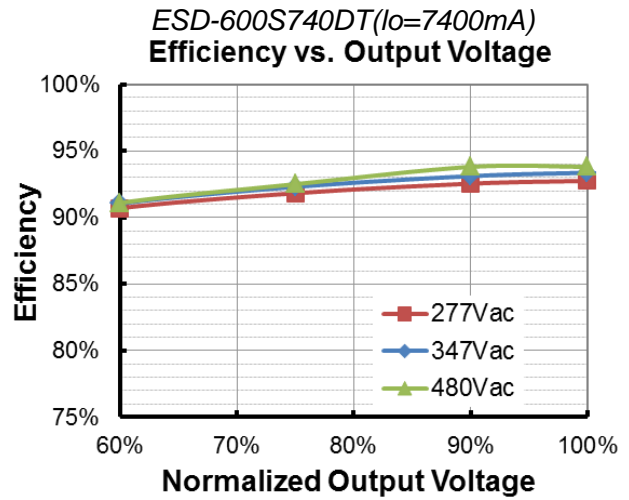
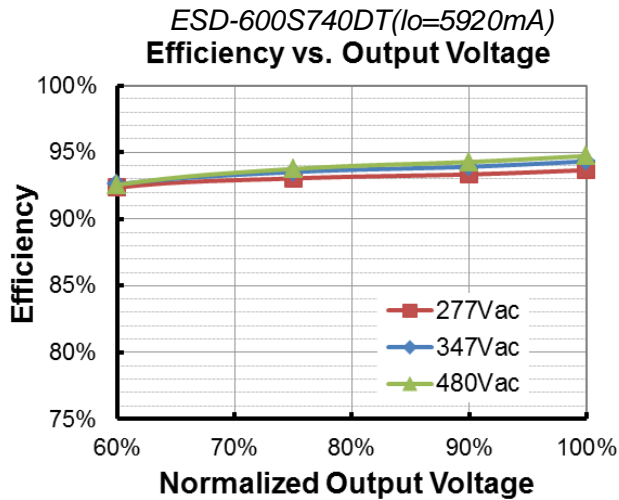

Power Factor

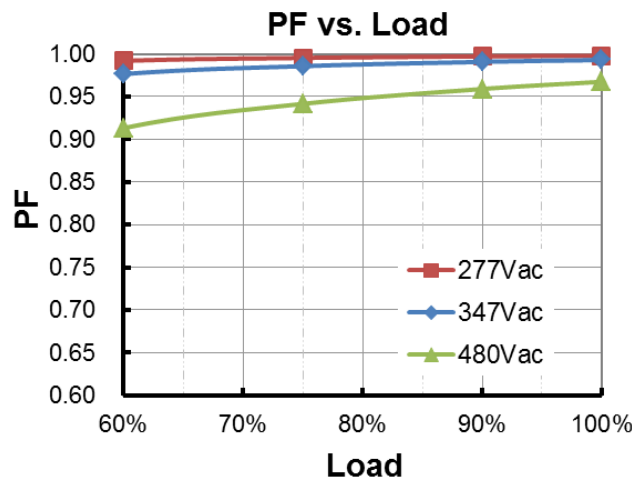

Total Harmonic Distortion

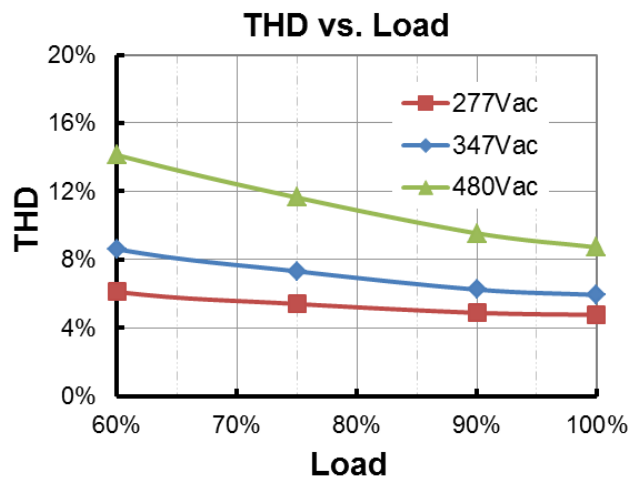

Protection Functions

Parameter		Min.	Typ.	Max.	Notes
External Thermal Protection NTC	R1	-	7.81 kOhm	-	When R _{NTC} falls below R1, External Thermal Protection is triggered, reducing output current until R2 is reached.
	R2	-	4.16 kOhm	-	When R _{NTC} is less than R2, output current is reduced to the programmed "Protection Current Floor."
	Protection Current Floor	10%loset	60%loset	100%loset	10%loset > lomin (default setting is 60%)
lomin		60%loset	100%loset	10%loset ≤ lomin (default setting is 60%)	
Over Temperature Protection		Decreases output current, returning to normal after over temperature is removed.			
Short Circuit Protection		Auto Recovery. No damage will occur when any output is short circuited. The output shall return to normal when the fault condition is removed.			
Over Voltage Protection		Limits output voltage at no load and in case the normal voltage limit fails.			

Dimming

● 0-10V Dimming

The recommended implementation of the dimming control is provided below.

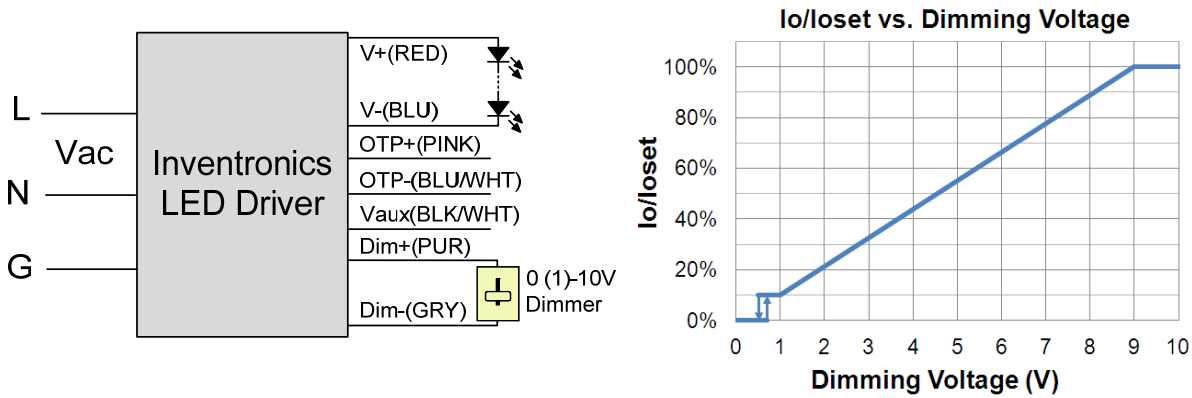

Implementation 1: DC Input

Notes:

1. The dimmer can also be replaced by an active 0-10V voltage source signal or passive components like resistors and zener.
2. Do NOT connect Dim- to the output V- or V+, otherwise the driver will not work properly.
3. If 0-10V dimming is not used, Dim + should be open.

● PWM Dimming

The recommended implementation of the dimming control is provided below.

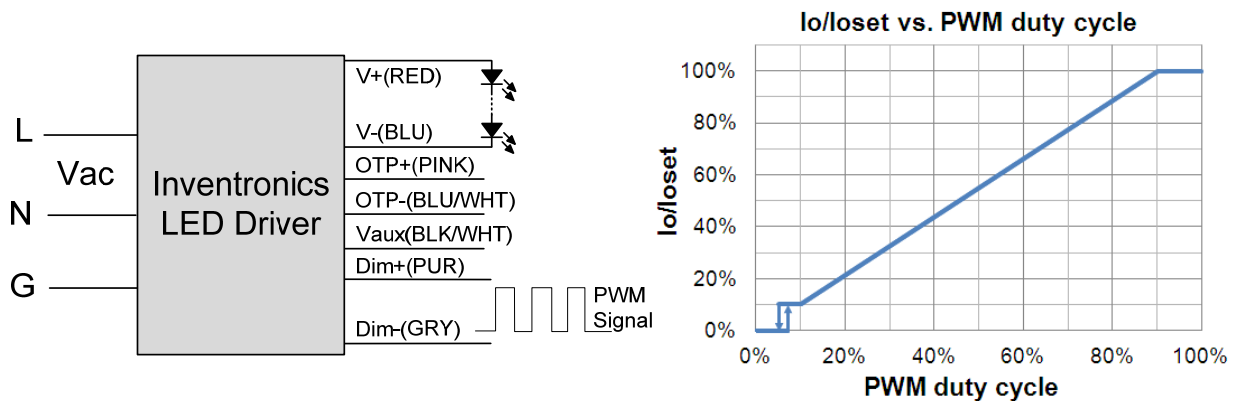

Implementation 2: Positive logic

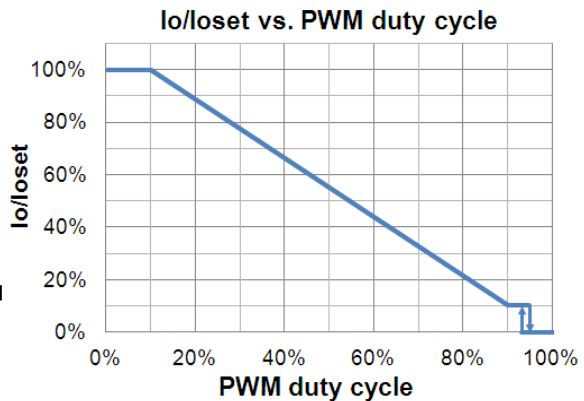
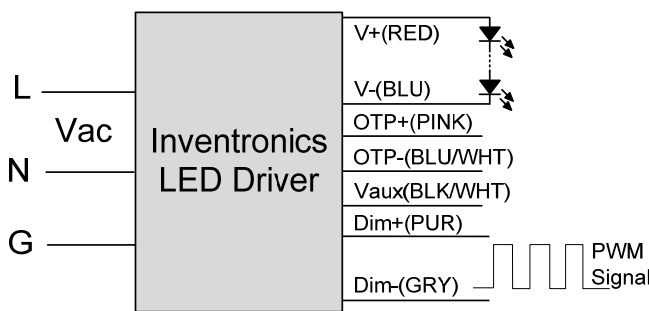

Implementation 3: Negative logic

● Time Dimming

Time dimming control includes 3 kinds of modes, they are Self Adapting-Midnight, Self Adapting-Percentage and Traditional Timer.

- **Self Adapting-Midnight:** Automatically adjusts the dimming curve based on the on-time of past two days (if difference <15 minutes), assuming that the center point of the dimming curve is midnight local time.
- **Self Adapting-Percentage:** Automatically adjusts the on-time of each step by a constant percentage = (actual on-time for the past 2 days if difference <15 min) / (programmed on-time from the dimming curve).
- **Traditional Timer:** Follows the programmed timing curve after power on with no changes.

● Output Lumen Compensation

Output Lumen Compensation (OLC) may be used to maintain constant light output over the life of the LEDs by driving them at a reduced current when new, then gradually increasing the drive current over time to counteract LED lumen degradation.

Programming Connection Diagram

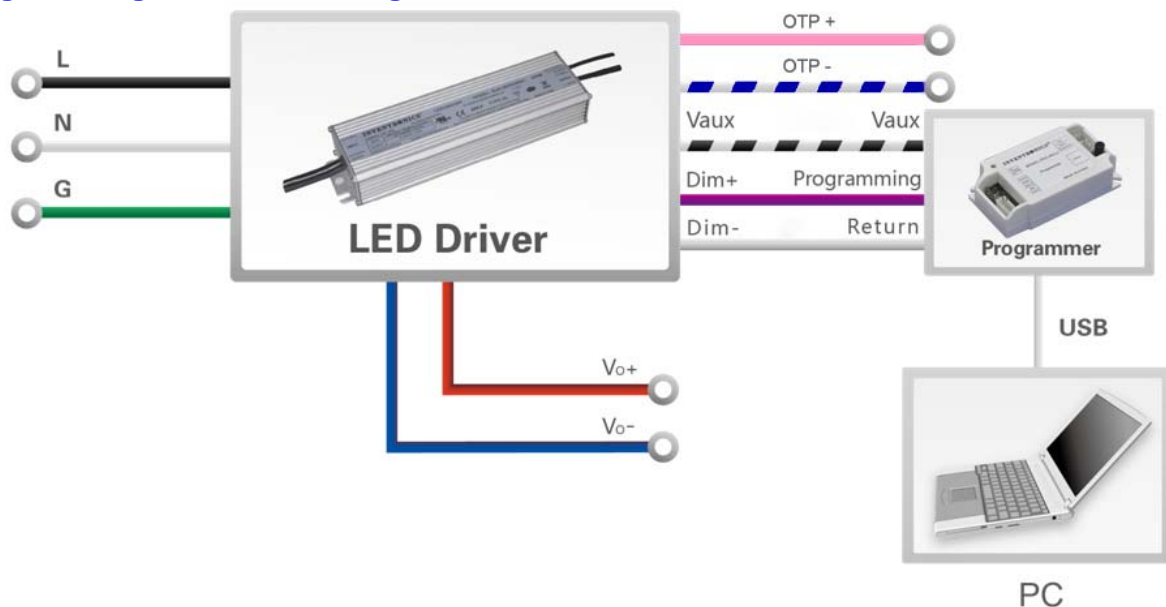

Note: The driver does not need to be powered on during the programming process.

- Please refer to [PRG-MUL2 \(Programmer\)](#) datasheet for details.

Mechanical Outline

ESD-600S210DT

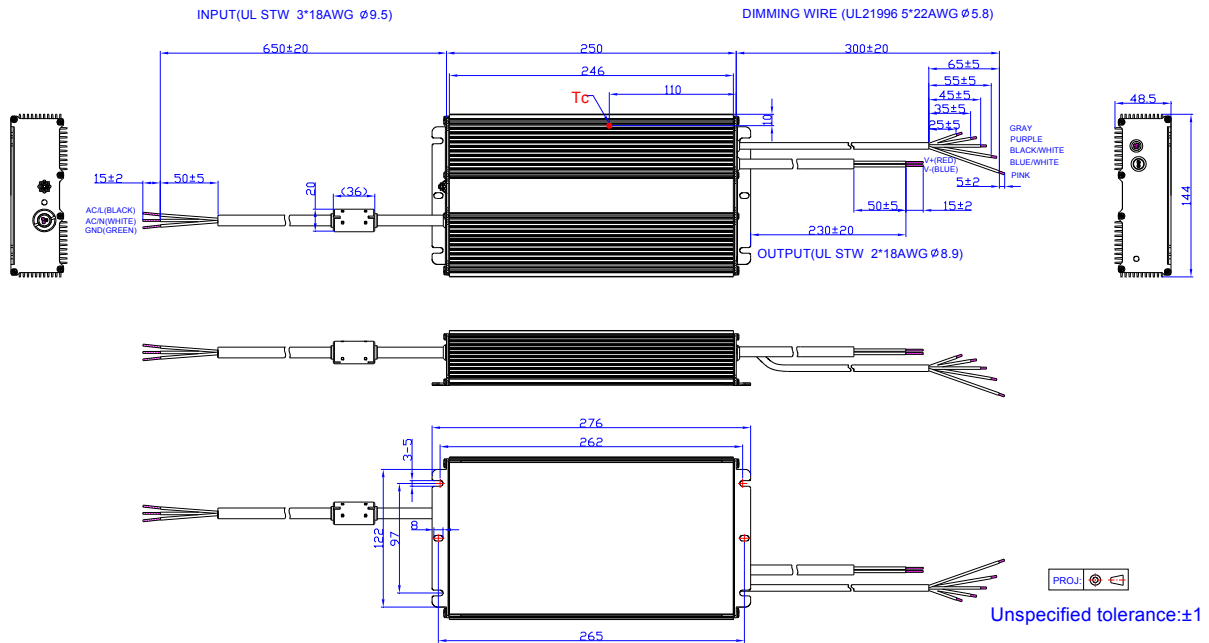

Others

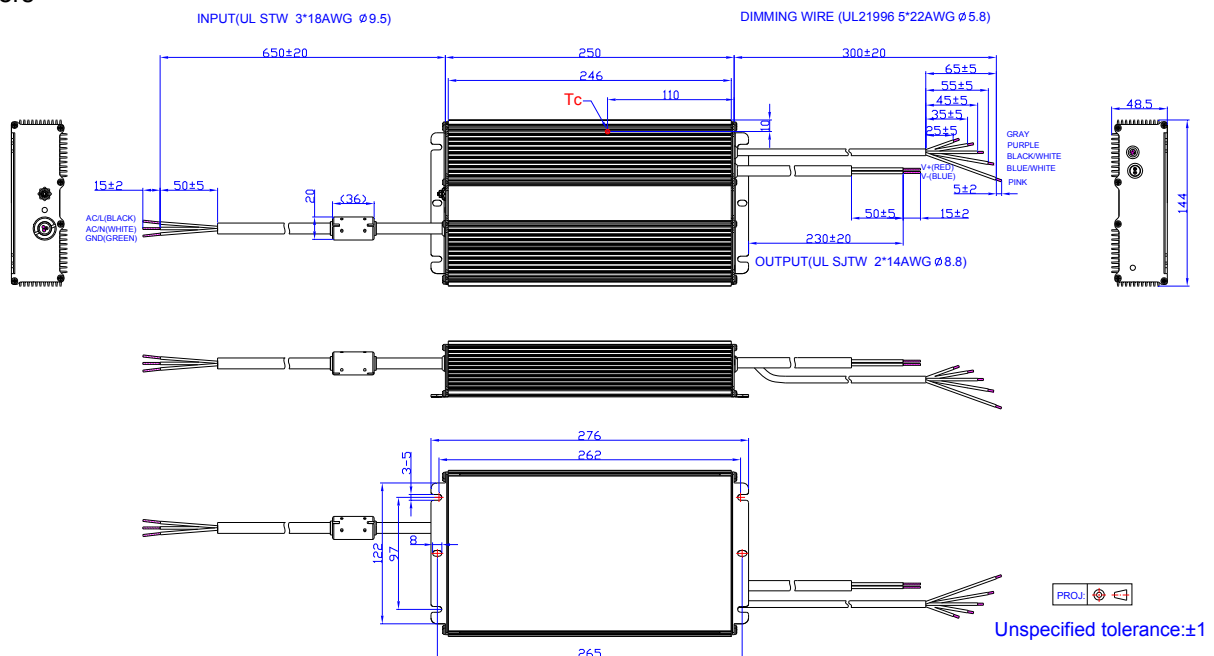

RoHS Compliance

Our products comply with reference to RoHS Directive (EU) 2015/863 amending 2011/65/EU, calling for the elimination of lead and other hazardous substances from electronic products.

Revision History

Change Date	Rev.	Description of Change		
		Item	From	To
2017-05-16	A	Datasheets Release	/	/
2017-09-22	B	Operating Area	ESD-600S420/560DT	Added
		Input Specifications	PF/THD	Updated
		Output Current Setting(Ioset) Range	ESD-600S420/560DT	Added
		Output Current Setting Range with Constant Power	ESD-600S420/560DT	Added
		No Load Output Voltage	ESD-600S420/560DT	Added
		Efficiency at 277 Vac input	ESD-600S420/560DT	Added
		Efficiency at 347 Vac input	ESD-600S420/560DT	Added
		Efficiency at 480 Vac input	ESD-600S420/560DT	Added
		Dimming Output Range	ESD-600S420/560DT	Added
		Efficiency vs. Load	ESD-600S420/560DT	Added
2017-12-27	C	Features	5 Years Warranty	Added
		Models	ESD-600S210DT	Added
		I-V Operation Area	ESD-600S210DT	Added
		Output Current Setting(Ioset) Range	ESD-600S210DT	Added
		Output Current Setting Range with Constant Power	ESD-600S210DT	Added
		No Load Output Voltage	ESD-600S210DT	Added
		Efficiency at 277Vac input	ESD-600S210DT	Added
		Efficiency at 347 Vac input	ESD-600S210DT	Added
		Efficiency at 480 Vac input	ESD-600S210DT	Added
		General Specifications	Operating Case Temperature for Warranty T _{c_w}	Updated
		Dimming Specifications	ESD-600S210DT	Added
		Efficiency vs. Load	ESD-600S210DT	Added
		Mechanical Outline	ESD-600S210DT	Added
2018-05-17	D	Description	/	Updated
		Models	ESD-600S170DT	Added
		I-V Operating Area	ESD-600S170DT	Added
		Output Current Setting(Ioset) Range	ESD-600S170DT	Added
		Output Current Setting Range with Constant Power	ESD-600S170DT	Added

Revision History (Continued)

Change Date	Rev.	Description of Change		
		Item	From	To
2018-05-17	D	Output Specifications	No Load Output Voltage	Updated
		Efficiency at 277 Vac input	ESD-600S170DT	Added
		Efficiency at 347 Vac input	ESD-600S170DT	Added
		Efficiency at 480 Vac input	ESD-600S170DT	Added
		Dimming Specifications	Dimming Output Range	Updated
		Efficiency vs. Load	ESD-600S170DT	Added
2019-12-02	E	Features	Timer Dimmable (3 Timer Modes)	3-Timer-Modes Dimmable
		Features	6kV line-line, 10kV line-earth	DM 6kV, CM 10kV
		Features	Waterproof (IP67)	IP67
		Description	under voltage lock out	Deleted
		Safety & EMC Compliance	EN 61000-4-5	Updated
		RoHS Compliance	/	Updated