

UP/DOWN & CCT SELECTABLE OUTDOOR WALL SCONCE LR40302

PLEASE READ CAREFULLY AND SAVE THESE INSTRUCTIONS, AS YOU MAY NEED THEM AT A LATER DATE.

CAUTION

1. TURN OFF ELECTRICAL POWER BEFORE STARTING INSTALLATION OF LIGHT FIXTURE.
2. THIS PRODUCT MUST BE INSTALLED IN ACCORDANCE WITH THE APPLICABLE INSTALLATION CODE BY A PERSON FAMILIAR WITH THE CONSTRUCTION AND OPERATION OF THE PRODUCT AND THE HAZARDS INVOLVED.
3. **CAUTION, RISK OF FIRE.** CONSULT A QUALIFIED ELECTRICIAN TO ENSURE CORRECT BRANCH CIRCUIT CONDUCTOR.
4. FOR EXTERNAL USE ONLY, RECOMMEND APPLYING WATERPROOF SILICONE TO SEAL AROUND TRIM AND CEILING.

GENERAL

ALL ELECTRICAL CONNECTIONS MUST BE IN ACCORDANCE WITH LOCAL AND NATIONAL ELECTRICAL CODE (N.E.C.) STANDARDS. IF YOU ARE UNFAMILIAR WITH PROPER ELECTRICAL WIRING CONNECTIONS, PLEASE HIRE A QUALIFIED ELECTRICIAN. REMOVE THE FIXTURE AND ITS COMPONENTS FROM THE BOX AND MAKE SURE THAT NO PARTS ARE MISSING.

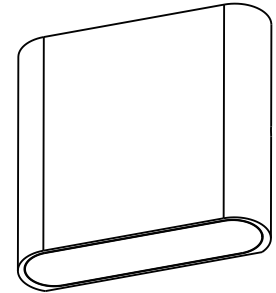

INSTRUCTIONS

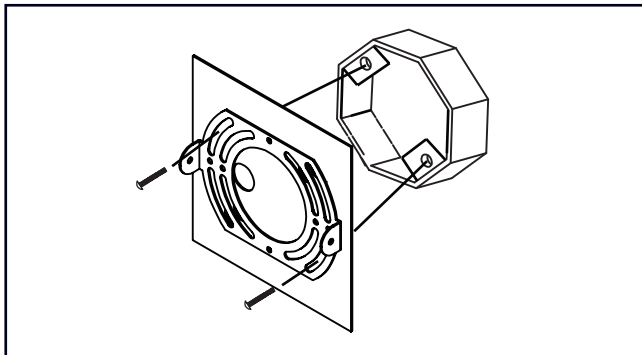

1. PRIOR TO INSTALLATION, INSTALL MOUNTING PLATE (INCLUDED) INTO THE ELECTRICAL BOX WITH MOUNTING SCREWS (INCLUDED). DRIVE SCREWS COMPLETELY TO THE END OF THE JUNCTION BOX.

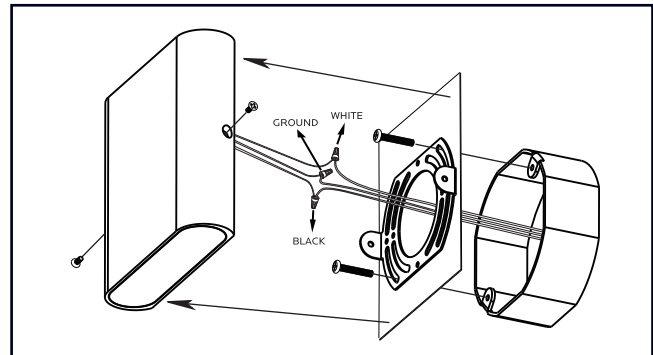

2. CONNECT SUPPLY WIRES TO WIRES ON FIXTURE WITH WIRE NUTS (INCLUDED). CONNECT WHITE TO WHITE, BLACK TO BLACK, AND COPPER WIRE TO GREEN WIRE AS A GROUNDING CONNECTION.

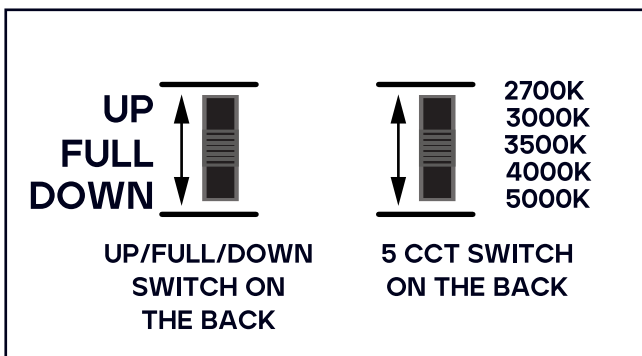

3. ADJUST LIGHT DIRECTION USING THE UP/FULL/DOWN SWITCH AND DESIRED COLOR USING THE 5 CCT SWITCH ON THE BACK TO YOUR DESIRED SETTINGS.

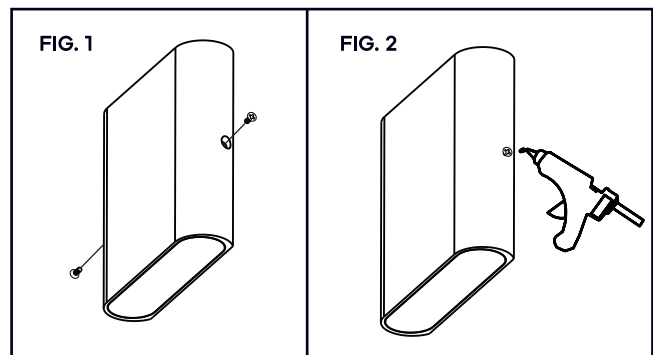

4. CAREFULLY TUCK ALL WIRES BACK INTO THE JUNCTION BOX. PUT THE WALL SCONCE OVER THE MOUNTING PLATE AND MATCH THE MOUNTING HOLES ON THE PLATE AND THE SCONCE (FIG.1), THEN DRIVE SCREWS COMPLETELY TO SECURE AND COMPLETE INSTALLATION. USE WATERPROOF SILICONE TO SEAL BETWEEN THE EDGES AND THE FIXTURE. (FIG. 2)