



LED LOW-PROFILE CANOPY WITH Q-BASE

► **DESIGN** - LED LOW-PROFILE CANOPY WITH Q-BASE has a built-in motion sensor base, allowing you to install the microwave motion or PIR sensor. Die-cast aluminum housing with excellent heat dissipation along with an anti-glare PC lens provides many years of use. It is equipped with a removable hinge door for quick and easy wiring. It is designed to operate on 120-277V circuits with a 1-10V dimmable driver.

► **BATTERY BACK-UP** - The built-in battery back-up provide 90 minutes of power in case of emergency.

► **COLOR SELECTABLE** - You can choose either a 3,000K warm white, 4,000K cool white or 5,000K daylight color temperature.

► **SURGE PROTECTION** - 6kV protects the fixture from voltage spikes and current surges.

► **INSTALLATION** - The fixture is Wet locations rated and can be either surface mounted or pole mounted. Perfect commercial or industrial solution for parking garages, gas stations, stairwells, passageways, underpasses, and many other applications.

► **ADVANTAGES** - With calculated lifespan up to 153,000 hours, these fixtures are made to last decades under normal operation! ASD provides a 5-year limited warranty along with UL and DLC Premium certifications to guarantee top quality products and safety!

Catalog number	
Notes	
Type	

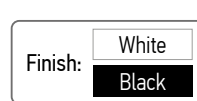

Model	Watts	Voltage	Dimmable	Lumens	CCT	Finish	Dimensions (LxWxH)	Option	
CAN07A									
ASD-CAN07A-45DAC-WH	45W	120-277 V	1-10 V	up to 6,917 lm	3CCT (3,000/4,000/5,000 K)	White	10-9/16" x 9-13/16" x 2-15/16"	-	
ASD-CAN07A-45DAC-BK	45W	120-277 V	1-10 V	up to 6,917 lm	3CCT (3,000/4,000/5,000 K)	Black	10-9/16" x 9-13/16" x 2-15/16"	-	
ASD-CAN07A-45BK	45W	120-277 V	1-10 V	up to 6,917 lm	3CCT (3,000/4,000/5,000 K)	Black	10-9/16" x 9-13/16" x 2-15/16"	-	
ASD-CAN07A-70DAC-WH	70W	120-277 V	1-10 V	up to 9,332 lm	3CCT (3,000/4,000/5,000 K)	White	10-9/16" x 9-13/16" x 2-15/16"	-	
ASD-CAN07A-70WH	70W	120-277 V	1-10 V	up to 9,332 lm	3CCT (3,000/4,000/5,000 K)	White	10-9/16" x 9-13/16" x 2-15/16"	-	
ASD-CAN07A-70DAC-BK	70W	120-277 V	1-10 V	up to 9,332 lm	3CCT (3,000/4,000/5,000 K)	Black	10-9/16" x 9-13/16" x 2-15/16"	-	
CAN07A-EM WITH BATTERY BACK-UP									
ASD-CAN07A-45DAC-8EM-BK	45W	120-277 V	1-10 V	up to 6,917 lm	3CCT (3,000/4,000/5,000 K)	Black	10-9/16" x 9-13/16" x 2-15/16"	8W Battery back-up	
ASD-CAN07A-45BK-8EM	45W	120-277 V	0-10 V	up to 6,917 lm	3CCT (3,000/4,000/5,000 K)	Black	10-9/16" x 9-13/16" x 2-15/16"	8W Battery back-up	
SENSORS AND REMOTE									
ASD-09MW-WH	Microwave motion sensor 3pin white							2-1/8" x 2-1/8" x 1-5/16"	-
ASD-09MW-BK	Microwave motion sensor 3pin black							2-1/8" x 2-1/8" x 1-5/16"	-
ASD-09IR-WH	Infrared motion sensor 3pin white							2-1/8" x 2-1/8" x 1-11/16"	-
ASD-09IR-BK	Infrared motion sensor 3pin black							2-1/8" x 2-1/8" x 1-11/16"	-
ASD-06RC	Remote control for motion sensor							5-11/16" x 1-3/4" x 13/16"	-
ASD-09MW-NLS-WH	Microwave motion sensor smart 3pin white							2-1/8" x 2-1/8" x 1-3/8"	-
ASD-09IR-NLS-WH	Infrared motion sensor smart 3pin white							2-1/8" x 2-1/8" x 1-11/16"	-
ASD-06RC-NLS	Remote control for motion sensor smart							5-11/16" x 1-3/4" x 13/16"	-

For detailed luminous flux information please refer to Annex 1.

For most up-to-date spec sheets please refer to asd-lighting.com



LED LOW-PROFILE CANOPY WITH Q-BASE

PRODUCT SPECIFICATIONS:

Construction & Materials			
Lens	PC		
Housing	Aluminum		
Finish	White, Black		
Weight	ASD-CAN07A-45DAC-WH	4.9 lbs (2.2 kg)	
	ASD-CAN07A-45DAC-BK		
	ASD-CAN07A-45BK		
	ASD-CAN07A-70DAC-WH	5.7 lbs (2.6 kg)	
	ASD-CAN07A-70WH		
	ASD-CAN07A-70DAC-BK	4.9 lbs (2.2 kg)	
	ASD-CAN07A-45DAC-8EM-BK	5.7 lbs (2.6 kg)	
ASD-CAN07A-45BK-8EM	4.9 lbs (2.2 kg)		
Environmental system			
Work environment	Suitable for Wet Locations, IP65		
Operating temperature	-40°F to 122°F (-40°C to 50°C)		
L-70 Life	R > 72,000 hrs; C > 153,000 hrs		
Optical system			
Color temperature	3CCT switch (3,000/4,000K/5,000 K), 5,000 K by default		
CRI	> 70		
Electrical system			
Input voltage	120-277 V		
Max input current	for 45W models: 0.5 A	for 70W models: 0.8 A	
Inrush current (Action time)	80 A (0.75 S)		
Off state power	0W		
Power consumption	ASD-CAN07A-45DAC-WH	45W	
	ASD-CAN07A-45DAC-BK		
	ASD-CAN07A-45BK		
	ASD-CAN07A-70DAC-WH	70W	
	ASD-CAN07A-70WH		
	ASD-CAN07A-70DAC-BK	45W	
ASD-CAN07A-45BK-8EM			
ASD-CAN07A-45DAC-8EM-BK			
Power factor	> 0.9		
Output voltage	110-130 V		
Max output current	for 45W models: 0.35 A	for 70W models: 0.55 A	
Surge protection DM/CM	4 kV / 6 kV		
Dimming range			
10-100%			
Dimming compatible controls			
Brand	Lutron	Leviton	Cooper
Models	DVSTV-453P	IP710-LFZ	DF10P SF10P
Regular and voluntary certifications			
5-year limited warranty			
DesignLights Consortium (DLC) listed (Classification: Premium) Main: Outdoor luminaires; General application: Mid output; Primary use: Parking garage luminaires			
UL certified E473804			

PACKAGE CONTENTS:

Description	Q-ty
LED Low-Profile Canopy with Q-base	1
Mounting plate (A)	1
Wire nut (B)	3
Self-tapping screw (C)	4
Anchor (D)	4
Box	1

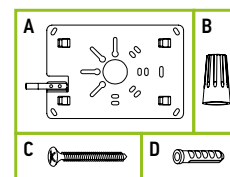

ACCESSORIES (sold separately):

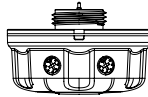
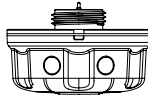
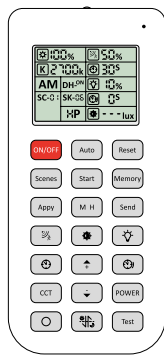
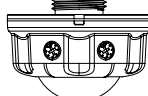
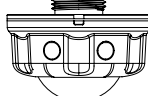
Microwave motion sensor 3pin ASD-09MW 	Microwave motion sensor smart 3pin ASD-09MW-NLS 	Remote control for motion sensor ASD-06RC for motion sensor smart ASD-06RC-NLS 
Infrared motion sensor 3pin ASD-09IR 	Infrared motion sensor smart 3pin ASD-09IR-NLS 	

ACCESSORY COMPATIBILITY LIST:

Models	Accessories	Microwave motion sensor 3pin	Infrared motion sensor 3pin	Microwave motion sensor smart 3pin	Infrared motion sensor smart 3pin
		ASD-09MW-WH ASD-09MW-BK	ASD-09IR-WH ASD-09IR-BK	ASD-09MW-NLS-WH	ASD-09IR-NLS-WH
ASD-CAN07A	45W	•	•	•	•
	70W	•	•	•	•
ASD-CAN07A-EM		•	•	•	•

For most up-to-date spec sheets please refer to asd-lighting.com



LED LOW-PROFILE CANOPY WITH Q-BASE

MOTION SENSOR INFORMATION

REMOTE CONTROL **ASD-06RC** **ASD-06RC-NLS** sold separately:

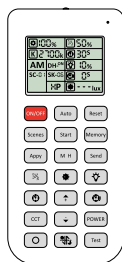

Button	Remarks	Button	Remarks	Button	Remarks
ON/OFF	ON/OFF Turn the sensor ON/OFF.	M H	Mounting height Adjust detection area/sensitivity levels according to real installation situations, higher or lower.	↑	Up The main functional buttons to adjust the factors to desired level.
Auto	Auto Enter "sensor mode" and perform previous settings.	Send	Send Memorize and send out the previous setting of individual parameters.	↓	Down Press + - button to dim light directly in non-detection mode.
Reset	Reset Enter "sensor mode" and perform the default settings.	☞	Detection range Also known as "sensitivity", 100 % means the highest sensitivity and longest distance. Use this button and the + - buttons to adjust.	CCT	CCT Selectable Not applicable to this product.
Scenes	Scenes Shows current settings saved in remote.	☞	Daylight sensor The preset lux level at which motion will be detected. Use this button and the + - buttons to adjust.	POWER	Power Adjust brightness in both ON/OFF mode & sensor mode, minimum 10%, max 100%, each time this button is pressed it changes by 5%.
Start	Start Press this to begin scene setup.	☞	Stand-by dimming After hold time, the light will dim from 100 % to optional standby dimming levels. Use this button and the + - buttons to adjust.	○	Reserved Button Not applicable to this product.
Memory	Memory Saves the scene settings.	☞	Hold time The period that light will stay illuminated 100 % after no motion is detected. Use this button and the + - buttons to adjust.	☞	Daylight Harvesting Daylight harvesting function enabled or disabled.
Apply	Apply Applies current scene settings to the fixture.	☞	Stand-by period The period after holdtime, during which the light keeps standby dimming level. Use this button and the + - buttons to adjust.	Test	Test button Press this button to test the sensor; it will temporarily change the hold time to 2s. This setting cannot be saved.

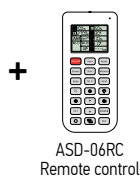
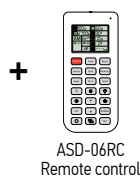

ASD-09MW, ASD-09MW-NLS:

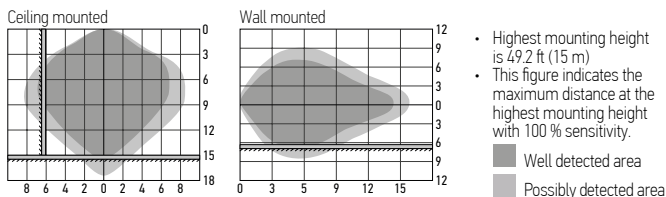

User notes:

- Microwaves can penetrate walls or glass thinner than 0.8" but will be impaired if thicker than 0.8".
- The driver voltage shall be stable and float within 10 %.
- Detection area will be affected by speed of motion, mounting height and movement volume.
- Conduct testing with adequate ambient lighting for best results.
- Dimming performance differs when connected to different drivers; if the driver can't completely turn OFF, sensor can't either.
- The first time powered ON sensor, light will be ON 100% for about 10S then dims to standby level or OFF.

Installation precautions:

- Suitable for ceiling mount installation, adjust sensitivity properly if it's installed on side-wall because it gets more sensitive.
- Make sure the microwave module is completely exposed.
- The detection surface of the sensor module should be installed facing the detection area.

Application environment:

- Suitable for indoor application, half/completely outdoor environment conditions might trigger the sensor.
- Shall be mounted securely, to avoid any false triggers caused by movement of the fixture itself.
- Keep the sensor module away from AC input and DC output to avoid high/low frequency signal interference.

Specifications	Models: ASD-09MW, ASD-09MW-NLS	Models: ASD-09IR, ASD-09IR-NLS
Operating voltage	10-15 V	
Operating current	< 30 mA	< 15 mA
Detection area	25 %/50 %/75 %/100 %	
Hold time	Remote control: 5 s/30 s/1 min/3 min/5 min/10 min/20 min/30 min	Built-in switch: 5 s/1 min/5 min/10 min
Daylight threshold	2 lux (0.2 fc)/10 lux (0.9 fc)/30 lux (2.8 fc)/50 lux (4.7 fc)/80 lux (7.4 fc)/120 lux (11.2 fc)/200 lux (18.6 fc)/250 lux (23.2 fc)/300 lux (27.9 fc)/350 lux (32.5 fc)/400 lux (37.2 fc)/disable	
Standby period	0 s/10 s/30 s/1 min/5 min/10 min/30 min/60 min/+ ∞	
Standby dimming level	Remote control: 10 %/20 %/30 %/50 %	Built-in switch: 0 %/10 %/30 %/50 %
Mounting height	max 49.2 ft (15 m)	≤ 39.4 ft (12 m)
Detection range	≥ 9 ft (3 m)	
Operating frequency	5.8 GHz ± 75 GHz	
Transmitting power	< 0.3 mW	

ASD-09IR, ASD-09IR-NLS:

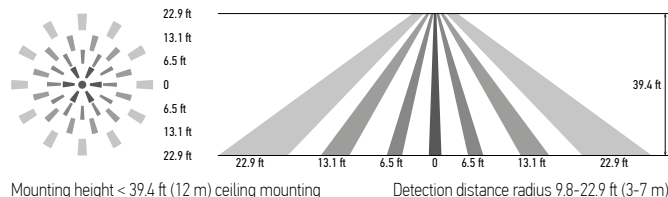

User notes:

- The driver voltage shall be stable and float within 10%.
- Detection area options may NOT working obviously because it works depends on fresnel lens, it's physically defined.
- Detection distance performance works better when moving parallel to the sensor as opposed to towards it.
- Conduct testing with adequate ambient lighting for best results.
- Dimming performance differs when connected to different drivers; if the driver can't completely turn OFF, sensor can't either.
- The first time powering ON the sensor, light will be ON 100% for about 45S then dims to standby level or OFF.

Installation precautions:

- PIR sensor can't be placed inside any material, fresnel lens must be completely exposed in air.
- Fresnel lens of the PIR sensor must be lower than light fixture.
- Suitable for ceiling mount installation, adjust sensitivity properly if it's installed on a wall because it will become more sensitive.

Application environment:

- Suitable for indoor application, half/completely outdoor environment conditions might trigger the sensor.
- Not suitable environment if there's sudden changed temperature of airflow for PIR sensor.
- Not suitable environment if there's shelves between the sensor and target area.
- Shall be mounted securely, to avoid any false triggers caused by movement of the fixture itself.

DEFAULT SETTING:

Specifications	
Detection area	100 %
Hold time	10 min
Daylight threshold	Disable
Stand-by period	0 s
Stand-by dimming level	10 %

For most up-to-date spec sheets please refer to asd-lighting.com



LED LOW-PROFILE CANOPY WITH Q-BASE

WITH DUSK/DAWN FUNCTION:

1. With insufficient ambient brightness, sensor turns on light and keeps it at standby dimming level even if there is no motion or presence.
2. When sensor detects motion or presence it will bring the light level up to 100 %.
3. After motion is no longer detected, fixture remains at 100 % for hold time.
4. After pre-set hold time period it will dim to standby dimming level again and always keep it.
5. With sufficient ambient brightness, sensor will turn OFF light automatically.

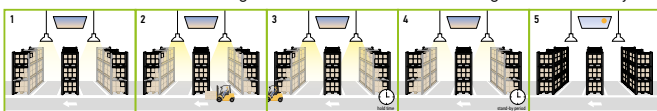

WITH DAYLIGHT DISABLED:

1. Sensor turns ON light when motion is detected.
2. Light will stay on after detecting motion for the desired hold time.
3. Sensor dims light to standby dimming level after hold time if there is still no motion.
4. Sensor turns OFF light after standby period.

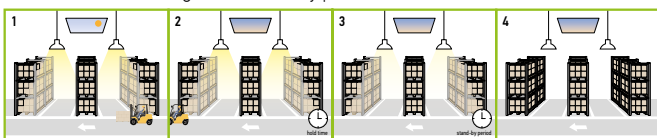

WITH DAYLIGHT THRESHOLD:

1. With sufficient daylight, the light remains OFF even after motion is detected.
2. With insufficient daylight, the sensor turns light ON when motion is detected.
3. After there's no motion detected, the sensor keeps light ON 100 % for holdtime.
4. After holdtime, sensor dims light to standby dimming level for standby period. If the standby period has been set as 0s, sensor turns light OFF automatically after holdtime.
5. The sensor turns OFF light automatically after the standby period when there's no motion detected.

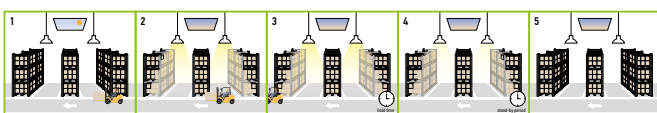

DAYLIGHT HARVESTING:

1. When ambient brightness is lower than preset lux level, sensor will turn on light automatically and keep dimming according to the change of the ambient brightness. As it gets darker outside the fixtures will brighten, and as it gets brighter outside the fixtures will dim down.
2. When the ambient brightness exceeds the preset lux level, the light will turn OFF.

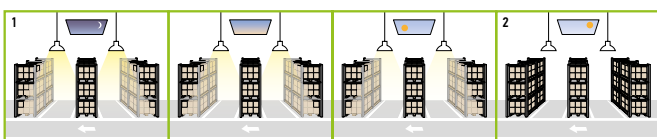

MICROWAVE MOTION SENSOR:

To avoid blocking the microwave emission, the microwave sensor can not be covered with metal materials, be sprayed with a coating of metal components, or have attached metal material or stickers etc.

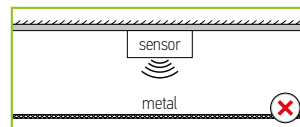

The distance between the antenna and the glass (dielectric material) should be no less than 0.4 ft when the sensor is within the glass lampshade. Otherwise, the microwave motion sensor will not penetrate the glass easily.

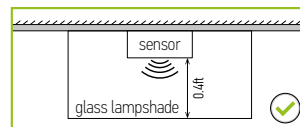

Avoid placing the sensor inside a metal chamber, this may cause a mis-trigger.

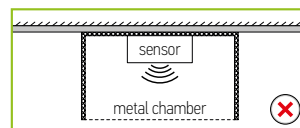

The sensor should not be placed in a small confined space. To avoid increasing the sensor detection range or abnormal operation, the sensor should be kept away from large areas of metal and glass reflectors (separation distance at least 3.3 ft). Reduce the detection area setting.

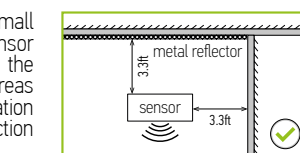

To avoid affecting the microwave signal transmission, the microwave antenna should be higher than the surrounding metal surface.

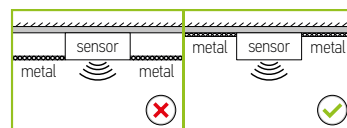

Any vibration or movement may trigger the sensor. Ensure the sensor is far from any constant movement.

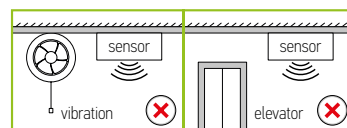

There must be at least 6.5ft between microwave sensors; There must be at least 4.9ft between the sensor and other wireless devices such as routers to avoid possible radio interference.

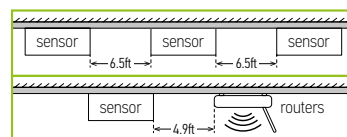

DAYLIGHT HARVESTING SETTING:

1. Adjust "daylight" value higher than 50lux.
2. Preset "standby period" 0S
3. Press MW/PIR button 3 times until the MW/PIR icons are both blinking on LCD screen, daylight harvesting function enabled. (With BLE version, press DH button, daylight harvesting function enabled).

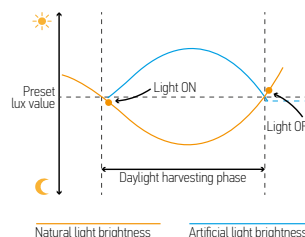

For most up-to-date spec sheets please refer to asd-lighting.com





LED LOW-PROFILE CANOPY WITH Q-BASE

BUILT-IN BATTERY BACK-UP INFORMATION

Specifications	Model: BLD-CM20H-1500400
Input voltage	100-277 V 50/60 Hz
Max emergency output power	15W
Warranty	5 years
Indicator light	Illuminated test switch, indicator light
Battery	Li-ion - 11.1 V / 4000 mAh
Lumens	2,194 lm
Emergency operation time	≥ 90 minutes
Battery charging current	250 mA
Emergency current	170 mA
Charging time	≥ 24 hours
Full charge/discharge cycles	500 cycles

STANDARD OPERATION DISPLAY STATUS:

Charging	
Emergency mode	

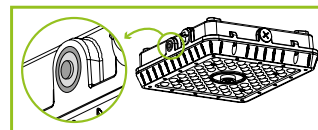

Indicator light modes:

- Red light ON - the battery back-up is charging in standby mode;
- Red light OFF - AC power is out, the battery back-up is working in emergency mode.

Test button operation: Press the test button to switch the system to back-up mode. The Red light will turn off, and the fixture will decrease in light amount. Release test button to go back to the normal mode.

INSTALLATION GUIDE

IMPORTANT SAFETY INFORMATION:

Please read all the instructions below before installation.

- ▶ Make sure that the supply voltage corresponds to the rated product voltage.
- ▶ The product must be installed by a qualified electrician in accordance with the National Electrical Code and corresponding local codes.
- ▶ If the product is damaged, do not use it.

ELECTRICAL SCHEMATIC DIAGRAM:

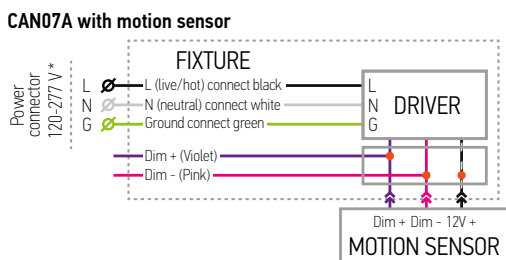
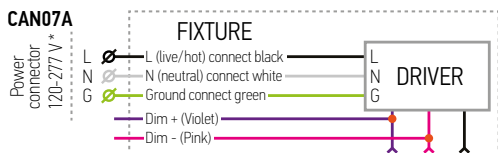

* The regular voltage 120-277V fixtures can be alternatively powered without neutral by two-phase circuit with phase-to-phase voltage of 208V (L1-120V & L2-120V).

WARNING: Phase-to-phase voltage should be less than 277V (160V per each phase) and more than 120V (70V per each phase)! Do not confuse Regular Voltage fixtures of 120-277V with High Voltage ones of 277-480V!

CAN07A-EM with battery back-up

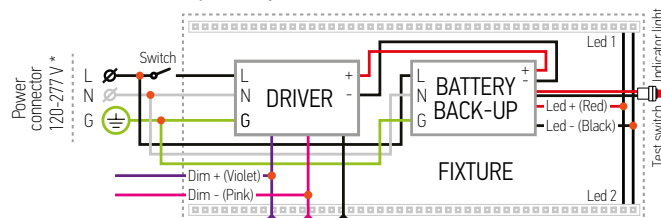

CAN07A-EM with motion sensor and battery back-up

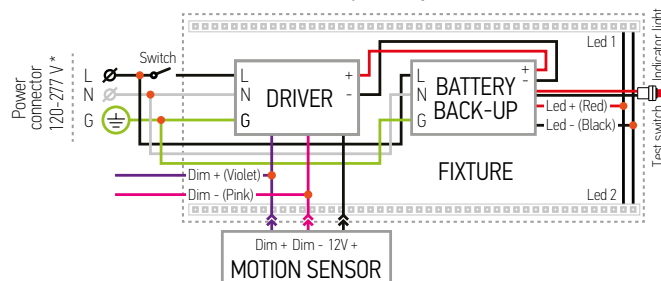

For most up-to-date spec sheets please refer to asd-lighting.com



LED LOW-PROFILE CANOPY WITH Q-BASE

SURFACE MOUNT WITH A MOUNTING PLATE:

1. Remove the securing screw out of the mounting plate, detach the mounting plate from the fixture housing and secure the plate to a j-box on the ceiling using anchors and self-tapping screws.
2. Connect the wires: Black to Black, White to White, Green to Green and secure connection to the Junction box in the ceiling.
3. Slide the fixture into the mounting plate clamps and secure it with a screw. Adjust color temperature (if needed) by unscrewing one big cap on the side of the fixture.

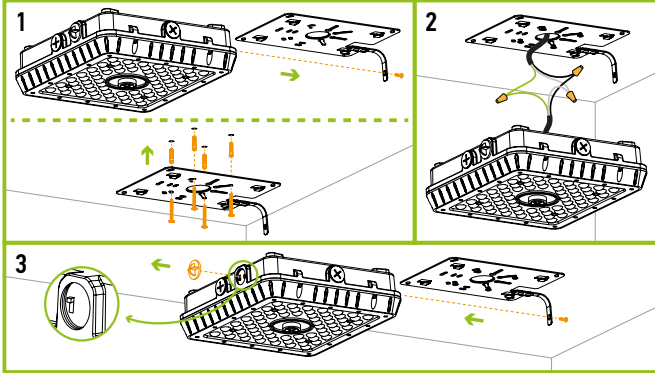

MOTION SENSOR INSTALLATION

ASD-09MW ASD-09MW-NLS
ASD-09IR ASD-09IR-NLS

sold separately:

1. Unscrew the microwave sensor base cap.
2. Insert and twist the sensor until it is tight on the base surface. FOR ASD-09-NLS sensors download ASD NLS APP using QR codes and add the fixture to it according to the manual.

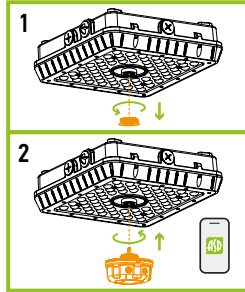

For ASD NLS sensors please download [link link](#) or QR-code below.



POLE MOUNTING INSTALLATION:

1. Remove the rubber cap, pass the AC wires from conduit through the hole into inside the fixture and screw the fixture to the G1/2" threaded conduit
2. Open the fixture by unscrewing two screws. Connect the wires: Black to Black, White to White, Green to Green.
3. Close the fixture, adjust color temperature (if needed) by unscrewing one big cap on the side of the fixture.

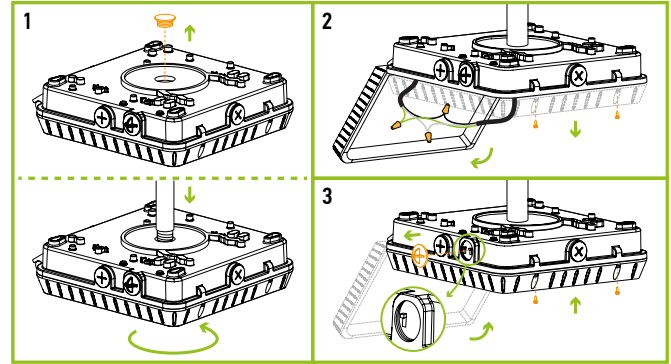

Model	Mount type
ASD-CAN07A-45DAC-WH	Bracket mount
ASD-CAN07A-45DAC-BK	Bracket mount
ASD-CAN07A-45BK	Pole + Bracket mount
ASD-CAN07A-70DAC-WH	Bracket mount
ASD-CAN07A-70WH	Pole + Bracket mount
ASD-CAN07A-70DAC-BK	Bracket mount
ASD-CAN07A-45DAC-8EM-BK	Bracket mount
ASD-CAN07A-45BK-8EM	Pole + Bracket mount

ASD NLS APP DOWNLOAD:

Android



IOS



For most up-to-date spec sheets please refer to asd-lighting.com

ASD LIGHTING CORP

E-mail: orders@asd-lighting.com | Web site: www.asd-lighting.com





LED LOW-PROFILE CANOPY WITH Q-BASE

ORDERING INFORMATION

Model	UPC	Pcs. per carton	Carton size	Carton weight	GTIN 14
CAN07A					
ASD-CAN07A-45DAC-WH	810128111157	6	22.4" x 12.8" x 12.8"	33.5 lbs	10810128111154
ASD-CAN07A-45DAC-BK	810128111140	6	22.4" x 12.8" x 12.8"	33.5 lbs	10810128111147
ASD-CAN07A-45BK	810128114820	6	22.4" x 12.8" x 12.8"	33.5 lbs	10810128114827
ASD-CAN07A-70DAC-WH	810128111171	6	22.4" x 12.8" x 12.8"	33.5 lbs	10810128111178
ASD-CAN07A-70WH	810128114837	6	22.4" x 12.8" x 12.8"	33.5 lbs	10810128114834
ASD-CAN07A-70DAC-BK	810128111164	6	22.4" x 12.8" x 12.8"	33.5 lbs	10810128111161
CAN07A-EM WITH BATTERY BACK-UP					
ASD-CAN07A-45DAC-8EM-BK	810128111188	6	22.4" x 12.8" x 12.8"	38.8 lbs	10810128111185
ASD-CAN07A-45BK-8EM	810128115469	6	22.4" x 12.8" x 12.8"	38.8 lbs	10810128115466

ACCESSORIES:

Model	Description	UPC	Pcs. in middle box	Middle box size	Middle box weight	GTIN 14 in middle box	Pcs. per carton	Carton size	Carton weight	GTIN 14 in carton
ASD-09MW-WH	Microwave motion sensor 3pin white	810128113700	10	5.5" x 2.6" x 11.4"	1.2 lbs	20810128113704	120	17.3" x 11.8" x 11"	12.1 lbs	30810128113701
ASD-09MW-BK	Microwave motion sensor 3pin black	810128113717	10	5.5" x 2.6" x 11.4"	1.2 lbs	20810128113711	120	17.3" x 11.8" x 11"	12.1 lbs	30810128113718
ASD-09IR-WH	Infrared motion sensor 3pin white	810128113694	10	5.5" x 2.6" x 11.4"	1.2 lbs	20810128113698	120	17.3" x 11.8" x 11"	12.1 lbs	30810128113695
ASD-09IR-BK	Infrared motion sensor 3pin black	810128114349	10	5.5" x 2.6" x 11.4"	1.2 lbs	20810128114343	120	17.3" x 11.8" x 11"	12.1 lbs	30810128114340
ASD-06RC	Remote control for motion sensor	810128114370	10	6.3" x 2.9" x 11.4"	0.5 lbs	30810128114371	60	15.8" x 11.8" x 9.3"	24.7 lbs	40810128114378
ASD-09MW-NLS-WH	Microwave motion sensor smart 3pin white	810128113762	10	5.5" x 2.6" x 11.4"	1.2 lbs	20810128113766	120	17.3" x 11.8" x 11"	12.1 lbs	30810128113763
ASD-09IR-NLS-WH	Infrared motion sensor smart 3pin white	810128113755	10	5.5" x 2.6" x 11.4"	1.2 lbs	20810128113759	120	17.3" x 11.8" x 11"	12.1 lbs	30810128113756
ASD-06RC-NLS	Remote control for motion sensor smart	810128114387	10	6.3" x 2.9" x 11.4"	0.5 lbs	20810128114381	60	15.8" x 11.8" x 9.3"	24.7 lbs	30810128114388

For most up-to-date spec sheets please refer to asd-lighting.com



LED LOW-PROFILE CANOPY WITH Q-BASE

ANNEX 1

Model	Watts	3,000 K	4,000 K	5,000 K
ASD-CAN07A-45DAC-WH ASD-CAN07A-45DAC-BK ASD-CAN07A-45BK ASD-CAN07A-45DAC-8EM-BK ASD-CAN07A-45BK-8EM	45W	6,230 lm	6,917 lm	6,900 lm
ASD-CAN07A-70DAC-WH ASD-CAN07A-70WH ASD-CAN07A-70DAC-BK	70W	8,381 lm	9,332 lm	8,945 lm

For most up-to-date spec sheets please refer to asd-lighting.com