

## 8W BACKLIT PANEL ENCLOSED EMERGENCY LED DRIVER LR35132

### IMPORTANT SAFEGUARDS

When using electrical equipment, basic safety precautions should always be followed, including the following:

#### READ AND FOLLOW ALL SAFETY INSTRUCTIONS.

- Risk of fire or electric shock. Luminaire wiring and electrical parts may be damaged when drilling for installation of LED Emergency Backup. Check for enclosed wiring and components.
- Risk of fire or electric shock. This LED Emergency Backup installation requires knowledge of luminaire electrical systems. If not qualified, do not attempt installation. Contact a qualified electrician.
- Before installing, make certain the AC power to the fixture is off.
- The electrical rating of this product is 100-347Vac. Installer must confirm that there is 100-347Vac to the fixture before installation.
- To prevent electrical shock only mate unit connector after installation is complete and before the AC power to the fixture is back on.
- Do not use in outdoor.
- This LED Emergency Backup unit requires an un-switched AC power source of 100-347Vac, 50/60Hz. The AC driver must be on the same branch circuit as the LED Emergency Backup unit.
- Do not let power supply cords touch hot surfaces.
- Do not mount near gas or electric heaters.
- Do not connect battery pack connector until all other wiring is complete and AC power is on.
- The emergency LED driver is for use with grounded, UL listed LED luminaires, shall be enclosed by the LED luminaire and bonded to the grounding of LED luminaire.
- Verify that all replacement lamp types marked on the installed luminaire are also identified as suitable for use with this emergency battery pack.
- The battery pack is fixed by screws and the indicator light is installed on the surface of luminaires.
- Equipment should be mounted in locations and at heights where it is not be subjected to tampering by unauthorized personnel.
- The use of accessory equipment is not recommended by the manufacturer and may cause an unsafe condition.
- Do not use this equipment for other than its intended use.
- Use with grounded, UL Listed, dry or damp location rated fixtures.
- **IMPORTANT:** Customers are advised to charge emergency LED driver 24 hours every 6 months during storage.
- **IMPORTANT:** Lighting fixture manufacturers, electricians, and end-users need to ensure product system compatibility test before using and final installation.



THIS PRODUCT CONTAINS A RECHARGEABLE LI-ION BATTERY.  
THE BATTERY MUST BE RECYCLED OR DISPOSED OFF PROPERLY.

## OPTIONAL TEST SWITCH

### SKINNY FILM TEST SWITCH

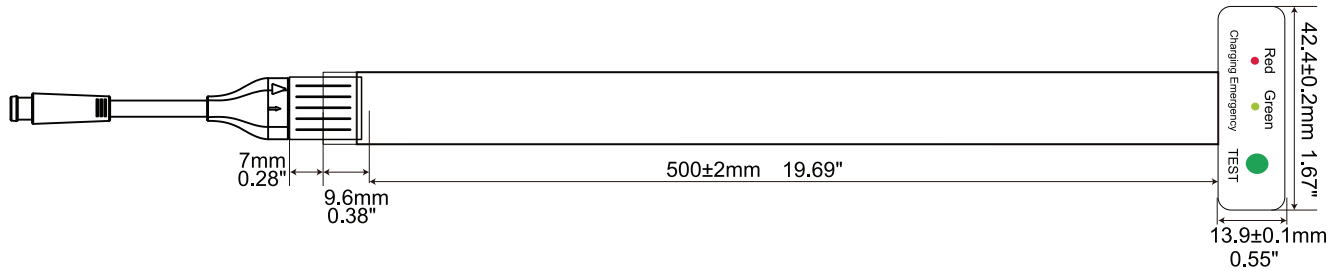

### M12 PLASTIC TEST SWITCH WITH FACE PLATE

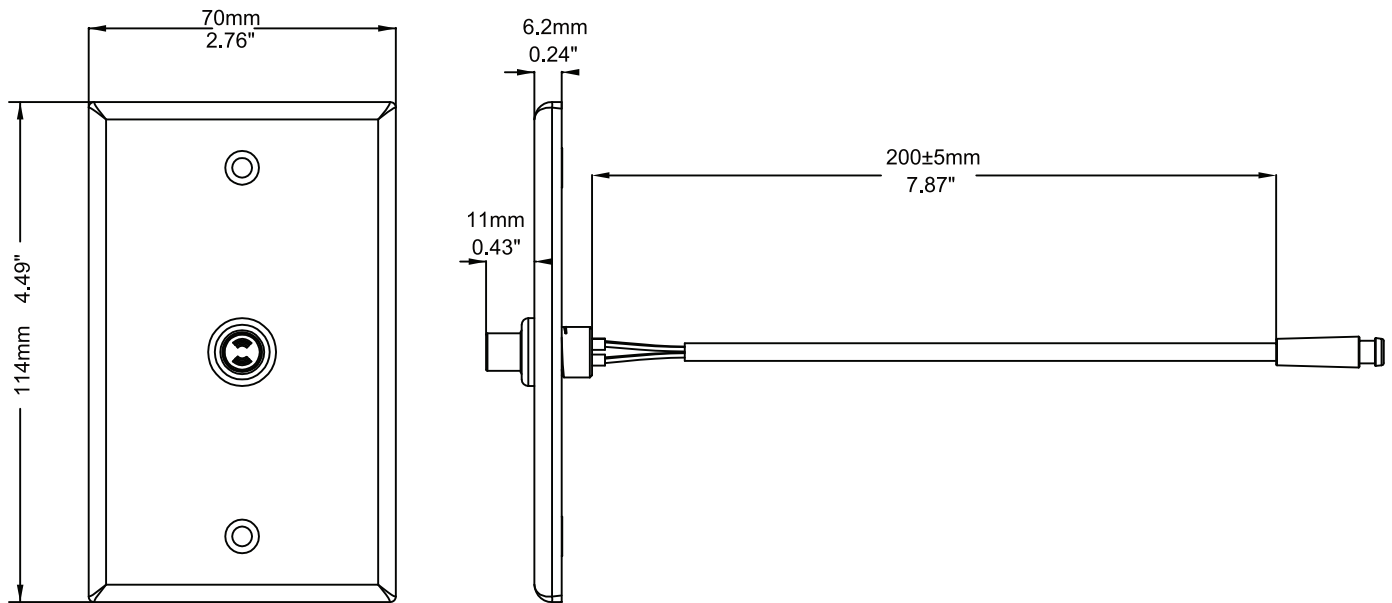

## OPERATION

**AC Operation:** AC power is present, The LED load from the LED driver is normal power supply, AC LED driver output current can not exceed 150W or 4A, the emergency driver is charging in a standby mode. The GREEN LED light flashes indicates that it is charging. The GREEN LED light on indicates that it is full charged.

**Emergency Operation:** When AC power fails, the emergency driver automatically switches to emergency mode, the indicator will be solid red, operating the LEDs for a minimum of 90 minutes. When AC power is restored, the emergency driver automatically returns to the charging mode.

This unit contains a control circuit that automatically performs a 30-second discharge test once a month and a full 90-minute discharge test once a year. During routine testing, the emergency driver simulates an AC power failure causing the unit to automatically switch to emergency mode. The unit will monitor the operation of the LED load, battery voltage, LED load connections and emergency duration. At the end of this test, if the emergency system functions properly, the unit will return to normal operation. Should the unit detect any problems, the indicator light will be yellow.

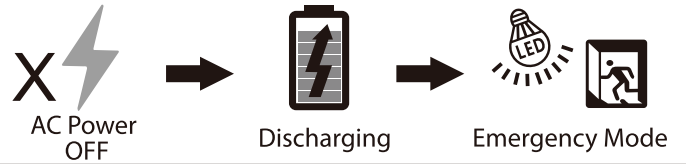
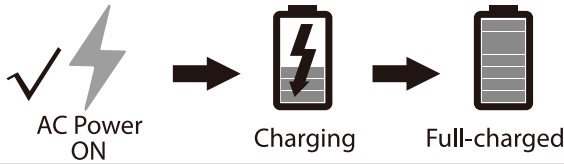

## INDICATOR LIGHT INTRODUCTION

- ① Green/Flashing: Charging
- ② Green/ON: Full-charged
- ③ Red/ON: Discharging(EM mode)
- ④ Red/Flashing: Low battery
- ⑤ Yellow: Error

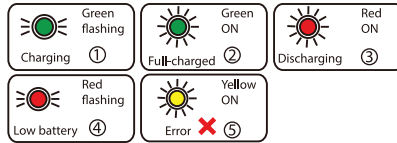

## TEST SWITCH INTRODUCTION

Press the test switch to confirm whether emergency function is normal

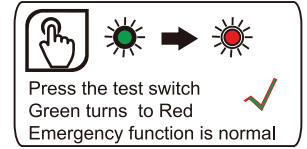

## WIRING DIAGRAM

1. For luminaire with 0-10V LED driver and using 0-10V dimmer (\* LED DRIVER INPUT POWER NOT GREATER THAN 60W) . Emergency Inverter Dim+ (Blue) , Driver Dim- (Yellow) has to connect with LED driver DIM+ and DIM-.

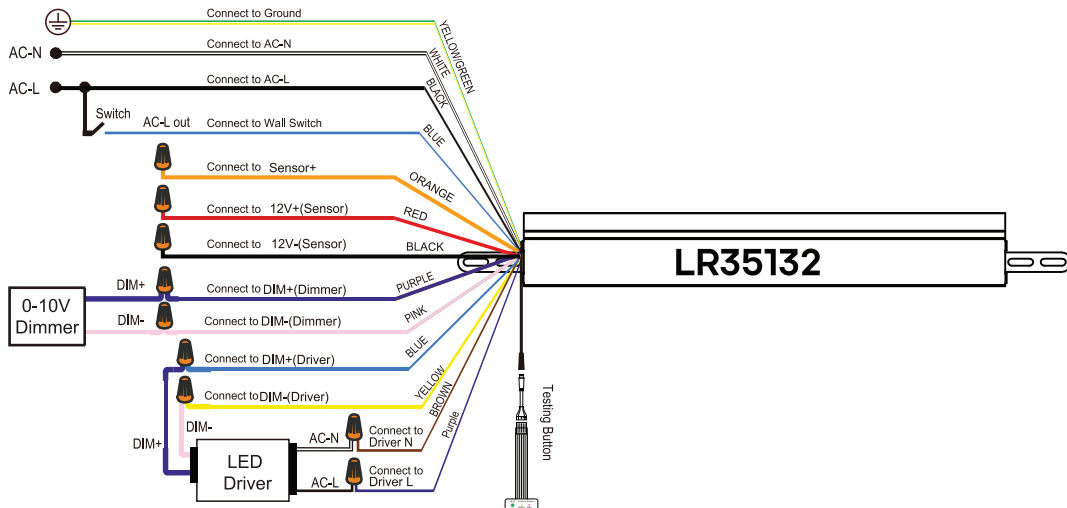

2. For luminaire with 0-10V LED driver, without using 0-10V dimmer (\* LED DRIVER INPUT POWER NOT GREATER THAN 60W). Emergency Inverter Dim+ (Blue) , Driver Dim- (Yellow) has to connect with LED driver DIM+ and DIM-.

