

## 3 CCT & WATTAGE SELECTABLE LED MICRO WALLPACK LR40580

### SURFACE MOUNT INSTALLATION

1. DO NOT REMOVE ANY PART OF THE FIXTURE.
2. See label on the fixture for specification.
3. Specification is as follows:
  - Rated Voltage: 600V
  - Rated connecting capacity: Min. 18AWG
  - Any necessary preparation of the ends of conductors: the length of exposed ends of conductors shall not exceed 8mm
4. Please mention the main specification as follows before wiring.

### WARNING

1. Before starting use of the light, please check if the light was damaged during transportation. If any damage is shown, please do not install or use.
2. The product itself and all its components should not be mechanically stressed.
3. Installation must not damage or destroy conducting paths or other parts of the product.
4. Installation of LED product (with power supplies) needs to be made with regard to all applicable electrical and safety standards. Only qualified personnel should be allowed to perform installation.
5. Correct electrical polarity needs to be observed. Wrong polarity may damage or destroy the LED products.
6. If fixing on metallic or otherwise conductive surfaces, there should be an electrical insulator between the product and the mounting surface.
7. All LEDs are static sensitive. Precautions should be taken to ensure that LEDs are well protected from ESD during handling, even though the chips are safe in low static-electric discharge events.
8. DO NOT operate LEDs in reverse bias.
9. Damaged by corrosion will not be honored as materials defect claim. It is the user's responsibility to provide suitable protection against corrosive agents such as moisture and condensation and other harmful elements.
10. Identify Positive (+) and negative (-) outputs of the power supply by using a multimeter.
11. Electrical connection should be in a dry area unless adequately sealed.
12. This product series emits high output. DO NOT look directly into the light emitting area. Direct exposure to the light over an extended time period may harm eyes.
13. If the external flexible cable or cord of this luminaire is damaged, it shall be exclusively replaced by the manufacturer or his service agent or a similar qualified person in order to avoid a hazard.

### 1. MIN 90°C SUPPLY CONDUCTORS / LES FILS D'ALIMENTATION 90°C MIN

### 2. SUITABLE FOR WET LOCATIONS / CONVIENT AUX EMPLACEMENTS MOUILLÉS

### 3. CAUTION - RISK OF FIRE. CAUTION - RISK OF SHOCK.

ATTENTION – RISQUE D'INCENDIE. ATTENTION – RISQUE DE CHOC.

### 4. THIS PRODUCT MUST BE INSTALLED IN ACCORDANCE WITH THE APPLICABLE INSTALLATION CODE BY A PERSON FAMILIAR WITH THE CONSTRUCTION AND OPERATION OF THE PRODUCT AND THE HAZARDS INVOLVED. CE PRODUIT DOIT ÊTRE INSTALLÉ SELON LE CODE D'INSTALLATION PERTINENT, PAR UNE PERSONNE QUI CONNAÎT BIEN LE PRODUIT ET SON FONCTIONNEMENT AINSI QUE LES RISQUES INHÉRENTS.



#### Correct Disposal of this product

This marking indicates that this product should not be disposed with other household wastes throughout the EU. To prevent possible harm to the environment or human health from uncontrolled waste disposal, recycle it responsibly to promote the sustainable reuse of material resources. To return your used device, please use the return and collection systems or contact the retailer where the product was purchased. They can take this product for environmental safe recycling.

## 3 CCT & WATTAGE SELECTABLE LED MICRO WALLPACK LR40580

### INSTALLATION INSTRUCTIONS

1. Turn off the power

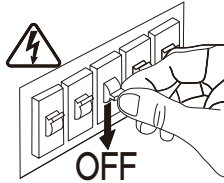

2. Remove the screws from the top cover.

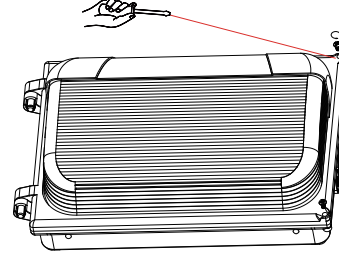

3. Open the lid.

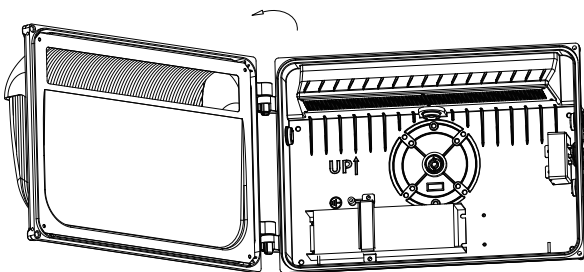

4. Fixed according to traditional installation method.

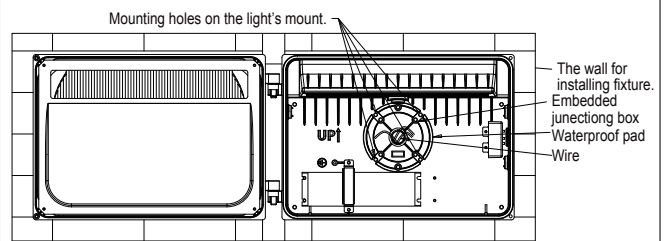

5. Connect the mains supply to the drive harness as shown in the figure.

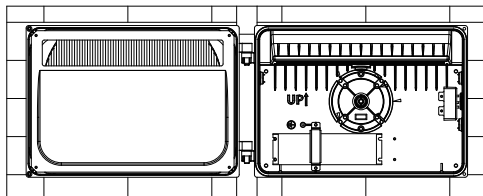

6. Wiring diagram.

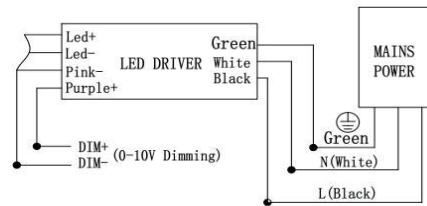

7. Close the lid and install the cap screws.

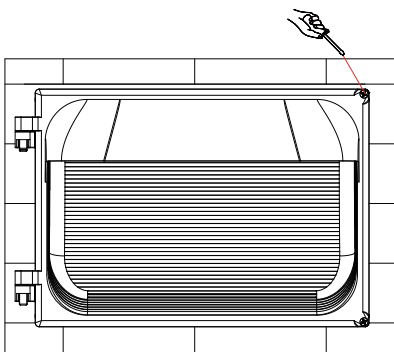

8. Installation completed.

