

## INSTALLATION INSTRUCTIONS

### 5LCS Series



#### ⚠ WARNING

These products may represent a possible shock or fire hazard if improperly installed or attached in any way. Products should be installed in accordance with these instructions, current electrical codes, and/or the current National Electric Code (NEC).

#### ⚠ WARNING

To reduce the risk of fire, electric shock or injury to persons, make sure that the electrical power to the system is disconnected at the source prior to installation or any servicing.

#### ⚠ WARNING

Caution: Injury to persons and damage to the fixture and/or mounting surface may result if the fixture is pulled from the surface. To reduce the likelihood of such injury or damage, mount on a surface that is mechanically sound.

#### IMPORTANT SAFETY INFORMATION

- Read all instructions before beginning. Save these instructions for future use.
- To reduce the risk of fire, electric shock, or injury to persons, pay close attention to this manual and stay within its guidelines when using this product.
- **CAUTION:** To reduce the risk of electric shock or injuries to persons, use only insulated staples or plastic ties to secure cords and only route/secure cords to that they will not be pinched or damaged when the cabinet is pushed to the wall.
- **CAUTION:** To reduce the risk of electric shock or injuries to persons, do not operate fixture with missing or damaged lens or wiring compartment cover.
- **WARNING! CAUTION - RISK OF FIRE:** Keep fixtures away from curtains and other combustible materials.
- Suitable for indoor dry locations only.
- Do not operate without an end connector cover in place for any Molex ports/connectors, not in use.
- Not intended for recessed installation in ceilings or soffits.
- LEDs are bright! Do not look directly at LED light source.
- Do not touch LEDs.
- There are no serviceable parts inside the LED module.
- The National Electrical Code (NEC) does not permit cords to be concealed where damage to insulation may go unnoticed.
- For cleaning, use a soft, dry or damp cloth. Do not use harsh chemicals or abrasives.
- This product is suitable for use in dimming circuits. It is compatible with most standard TRIAC, CL, and ELV dimmers (5-100% light control).

#### PRE-INSTALLATION NOTES:

5LCS fixtures can be hardwired directly via rear access door, or hardwired indirectly via the Hardwire Junction Box, or powered by a 120V receptacle. Fixtures can be powered by an adjacent fixture using linking cables. Determine installation method and purchase necessary accessories separately. Available Accessories (sold separately) include **5LCS-BOX**: 120V Hardwire Junction Box, **5LCS-PC6**: 120V AC Power Cord (6ft length), and **5LCS-EX**: Interconnectable linking/jumper cable (6" and 12" lengths). To change the color temperature, use the CCT slider switch near the On/Off switch.

#### CONNECTING POWER VIA SUPPLY WIRES THROUGH REAR ACCESS DOOR (See Figures 1-4):

The rear access door is located in the center of the back of the fixture housing. It has its own knockout for quick connection to supply wires, foregoing the need to remove the lens cover and open the wiring compartment.

1. Remove knockout using a hammer or punch, then loosen the screw that secures the rear access door using a Philips head screwdriver or driver bit. Use a screwdriver to fix the light fixture to a suitable position. See Figure 1.
2. Install the 3/8" cable connector (included) for the supply wire following National Electric Code and local codes through this knockout on the access door. See Figure 2. AC should be protected by circuit breaker or fuse.
3. Strip back jacket on supply wires to 3/8" and use push-in wire connectors inside housing to connect the wires, matching polarity (Black to Black = Hot, White to White = Neutral, Yellow/Green to Bare Wire = Ground) through knockout so that push-in connectors are positioned on the housing side of the access door. See Figure 3.
4. Replace rear access door and tighten retaining screw. Be sure that the wires are not pinched or damaged by any part of the housing or the cover. See Figure 4.

FIGURE 1

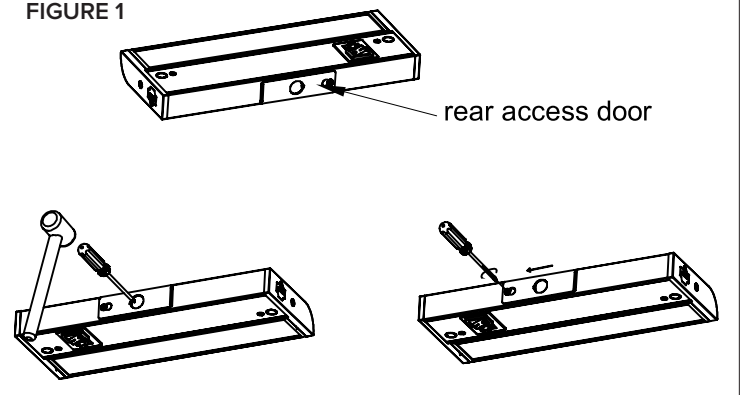

FIGURE 2

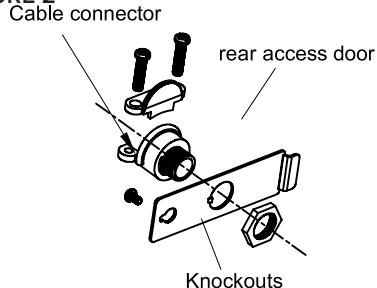

FIGURE 3

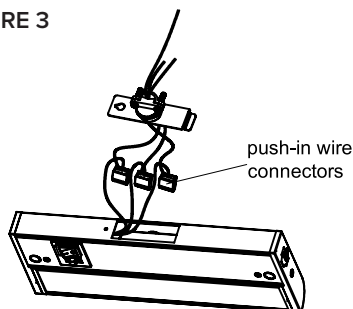
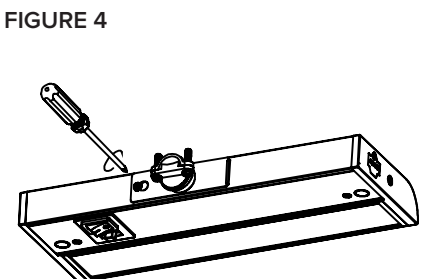

FIGURE 4



CONTINUED ON NEXT PAGE

## INSTALLATION INSTRUCTIONS

### 5LCS Series



#### MOUNTING FIXTURE (See Figures 5):

1. Determine locations for each fixture. Connect supply wires via knockouts before mounting.
2. Use a Phillips head screwdriver or driver bit to tighten captive mounting screws and secure fixture to an appropriate mounting surface.

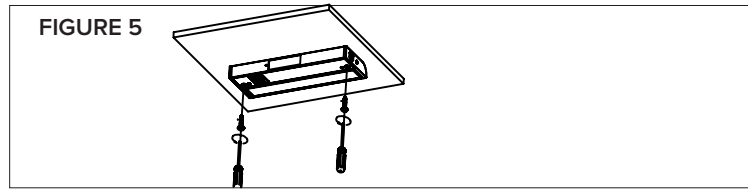

#### CONNECTING POWER VIA POWER CORD:

120V power cord (optional, sold separately). Never use with an extension cord unless the plug can be fully inserted. Do not alter plug.

1. Position fixture in desired location and use a Phillips head screwdriver or driver bit to tighten captive mounting screws in order to secure the fixture to an appropriate mounting surface.
2. Remove the side port cover and insert the power cord into side port labeled "input" until fully seated.

#### INTERCONNECTING FIXTURES (SEE FIGURE 6):

1. Interconnecting via inking/jumper cable: To interconnect nearby fixtures, remove the adjacent port covers and utilize linking cable (sold separately) as shown in Figure 5.
2. Interconnecting via end-to-end linking connector: To interconnect fixtures directly to each other (end-to-end), utilize the in-line connector (included with each fixture) by removing adjacent port covers and inserting fully.

#### CONNECTING POWER VIA SUPPLY WIRES THROUGH HOUSING KNOCKOUTS (See Figures 7-8):

This type of installation is less common and typically only done when the rear access door cannot be utilized.

1. Open wiring compartment by removing screws at each end and lifting cover from housing body. See Figure 7.
2. Punch out the knockout best suited for connection to 120V supply wires. Knockouts are located along back and top of housing. See Figure 8.
3. Install cable connector and connect fixture wires following National Electric Code and/or local building code requirements. Use minimum 18AWG solid copper wires. AC supply should be 120V protected by circuit breaker or fuse.
4. Attach line voltage AC supply wires to fixture lead wires: Black to Black/Hot, White to White/Neutral and Yellow/Green (Ground) to Green or bare wire inside the fixture. Secure each connection using push-in wire connectors provided on the fixture lead wire. If your system has no ground wire, consult a qualified electrician before proceeding with the installation. Note: Electric shock, overheating, low or no light output, and shortened fixture life can result if proper grounding is not done.
5. Replace the wiring compartment cover, securing with the existing retaining screws. Note: Be sure that the wires are not pinched or damaged by any part of the housing or the cover.
6. Follow directions above for mounting fixture.

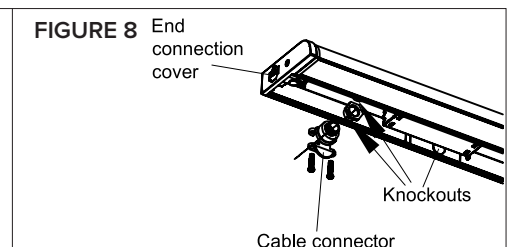
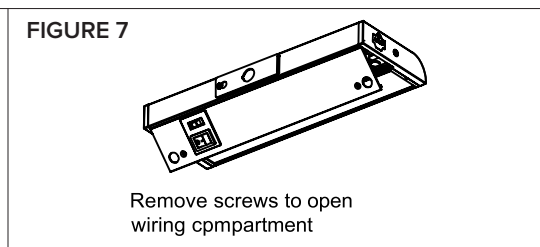
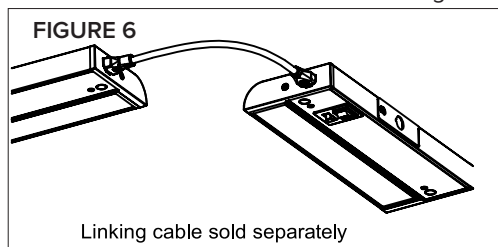

#### FCC Compliance Statement

This device complies with part 15 of the FCC Rules. Operation is subject to the following two conditions:

1. This device may not cause harmful interference, and
2. This device must accept any interference received, including interference that may cause undesired operation.

#### FCC WARNING

This equipment has been tested and found to comply with the limits for a Class B digital device, pursuant to Part 15 of the FCC Rules. These limits are designed to provide reasonable protection against harmful interference in a residential installation. This equipment generates, uses and can radiate radio frequency energy and, if not installed and used in accordance with the instructions, may cause harmful interference to radio communications. However, there is no guarantee that interference will not occur in a particular installation. If this equipment does cause harmful interference to radio or television reception, which can be determined by turning the equipment off and on, the user is encouraged to try to correct the interference by one or more of the following measures:

- Reorient or relocate the receiving antenna.
- Increase the separation between the equipment and the receiver.
- Connect the equipment into an outlet different from that to which the receiver is connected.
- Consult the dealer or an experienced radio/TV technician for help.

Any changes or modifications not expressly approved by the party responsible for compliance could void the user's authority to operate the equipment.

#### 3 YEAR LIMITED PRODUCT WARRANTY

This product is warranted to be free from defects in material and workmanship for a period of three years from the date of purchase. Products that prove to be defective during this period will be either repaired (i.e. replacement of defective electronics, defective parts of the fixture housing, lens, wiring, switching or lamp sockets; excluding the lamp) or replaced, at the discretion of American Lighting, Inc. Claims for defective products must be submitted to the retail location from which the product was purchased within the warranty period. Upon submission of proper return claim documentation and product to American Lighting, Inc by the retailer, American Lighting, Inc reserves the right to inspect the product for misuse or abuse. Claims for indirect or consequential damages or for product that, in American Lighting Inc's opinion has been misused will be denied. This is a warranty of product reliability only and not a warranty of merchantability or fitness for a particular purpose. American Lighting, Inc shall have no liability whatsoever in any event for payment of incidental or consequential damages, including, without limitations, installation costs and damages for personal injury and property. These products may represent a possible shock or fire hazard if improperly installed or altered in any way. This warranty applies only to product that has been properly installed in accordance with instruction sheet and current local codes and/or the National Electrical Code. Warranty does not apply to any product that has been improperly installed or in situations where components have been altered in any way.

For questions, comments, technical assistance and/or repair parts, please call toll free at: 1-800-285-8051 (M-F 8am - 5pm, MST)

#### LIGHT DISTRIBUTION:

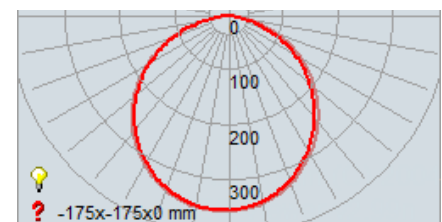

Model #	Amperage	Wattage
5LCS-10	0.065	7
5LCS-16	0.105	11
5LCS-24	0.135	15
5LCS-32	0.155	16.5