

ELECTRONIC - CONSTANT VOLTAGE 5 IN 1 DIMMABLE DRIVER

TRIAC/PHASE, 0-10V, 1-10V, POTENTIOMETER, 10V PWM

LR36167

LED/EDRV/150W/24V/UNV/D5/JB



150W DRIVER

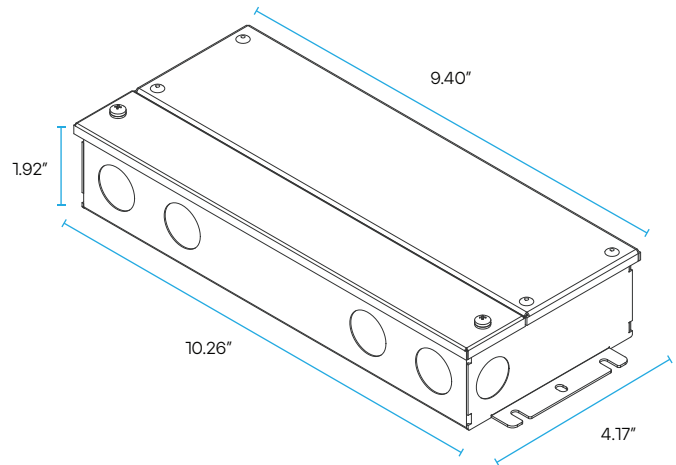

OUTPUT	RATED POWER	150W
	DC VOLTAGE	24V
	RATED CURRENT	6.25A
	VOLTAGE TOLERANCE	±0.5V
	VOLTAGE REGULATION	±0.5%
	LOAD REGULATION	±1%
INPUT	VOLTAGE RANGE	110-277VAC
	FREQUENCY RANGE	47-63Hz
	POWER FACTOR (TYP.) @ FULL LOAD	0.99 @ 120VAC - 0.95 @ 277VAC
	THD (TYP.) @ FULL LOAD	<20%
	EFFICIENCY (TYP.) @ FULL LOAD	85% @120VAC 90%@277VAC
	AC CURRENT (MAX)	1.8A
	INRUSH CURRENT (TYP.)	35A, 960us @50% 120VAC - 43A, 1ms @ 50% 277VAC
	LEAKAGE CURRENT	<0.50mA
PROTECTION	SHORT CIRCUIT	Shut down o/p voltage, re-power on to recover after fault condition removed
	OVER LOADING	≤120%
	OVER TEMPERATURE	212° F (100°C) ±50°F (10°C) shut down o/p voltage, automatically recover after cooling
ENVIRONMENT	WORKING TEMP	-40~+140°F (-40~60°C)
	WORKING HUMIDITY	20~95%RH
	STORAGE TEMP. HUMIDITY	-40~+176°F (-40~80°C)
	TEMP. COEFFICIENT	±0.03% /°C (0~50°C)
	VIBRATION	10-500Hz
SAFETY & EMC	SAFETY STANDARDS	UL8750
	WITHSTAND VOLTAGE	1.88KVAC
	ISOLATION RESISTANCE	100M/500VDC/25°C/70%RH
	EMC EMISSION	FCC 47 CFR Part 15, Subpart B
CASE	NET WEIGHT	4.36lb (1.98 KG)
	SIZE	10.26" X 4.17" X 1.92" (L*W*H)
	CARTON SIZE	10 PCS/CTN