

## Features

- High Efficiency (Up to 92.0%)
- Two Independent Output Channels (Isolated)
- Two Independent Dimming Channels (Isolated)
- Full Power at Wide Output Current Range (Constant Power)
- 0-5V/0-10V/PWM/3-Timer-Modes Dimmable
- Input Surge Protection: DM 6kV, CM 10kV
- All-Around Protection: IUVP, OVP, SCP, OTP
- IP67 and UL Dry / Damp / Wet Location
- Class 2 & SELV Output
- TYPE HL, for use in a Class I, Division 2 hazardous (Classified) location
- UL Class P Type
- 7 Years Warranty



## Description

The EUG-192DxxxDT series is a 192W, two-channel, constant-current, programmable LED driver that operates from 90-305 Vac input with excellent power factor. It is created for many lighting applications including high bay, roadway, tunnel and horticulture, etc. The high efficiency of these drivers and compact metal case enables them to run cooler, significantly improving reliability and extending product life. To ensure trouble-free operation, protection is provided against input surge, output over voltage, short circuit, and over temperature.

## Models

Adjustable Output Current Range	Full-Power Current Range (1)	Default Output Current	Input Voltage Range (2)	Output Voltage Range	Max. Output Power	Typical Efficiency (3)	Power Factor		Model Number
							120Vac	220Vac	
70-1050mA	700-1050mA	700 mA	90~305Vac/ 127~250Vdc	48~137Vdc	192W	92.0%	0.99	0.96	EUG-192D105DT
175-2650mA	1750-2650mA	2100 mA	90~305Vac/ 127~250Vdc	18~54Vdc	192W	91.0%	0.99	0.96	EUG-192D265DT <sup>(4)</sup>
265-4000mA	2650-4000mA	2800 mA	90~305Vac/ 127~250Vdc	12~36Vdc	192W	91.0%	0.99	0.96	EUG-192D400DT <sup>(4)</sup>

- Notes:** (1) Output current range with constant power at 192W.  
 (2) Certified input voltage range: UL, FCC 100-277Vac or 127-250Vdc; otherwise 100-240Vac or 127-250Vdc (except KS).  
 (3) Measured at 100% load and 220Vac input (see below "General Specifications" for details).  
 (4) Class 2 & SELV output.

## I-V Operation Area

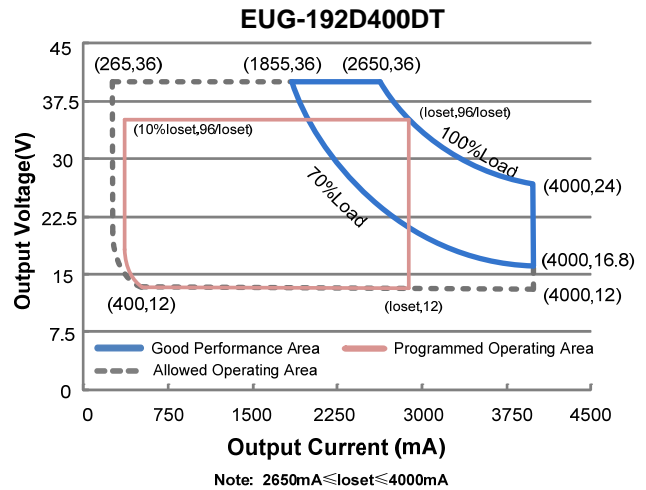
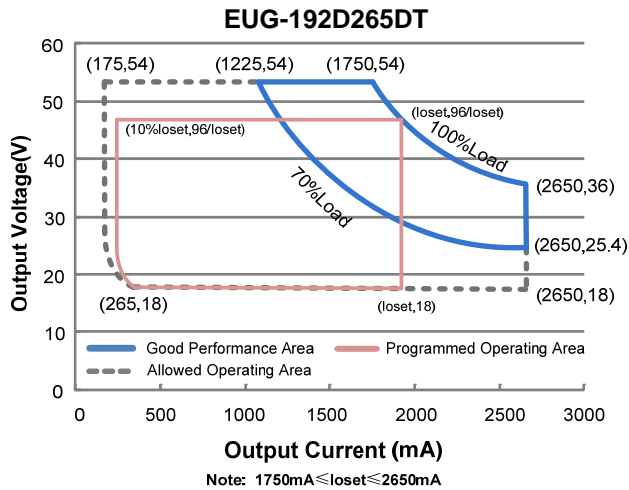
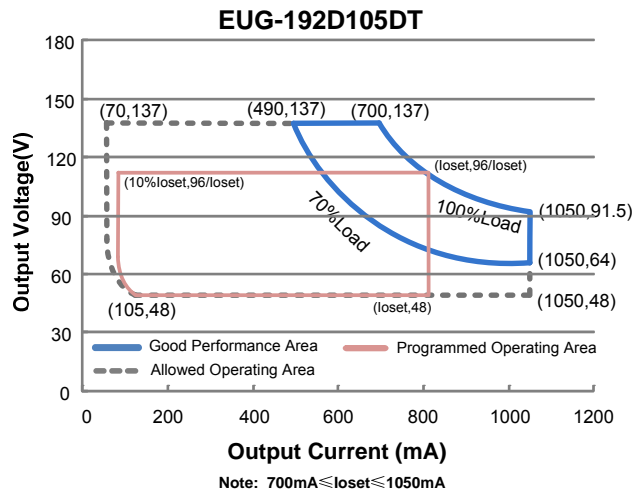

## Input Specifications

Parameter	Min.	Typ.	Max.	Notes
Input Voltage	90 Vac	-	305 Vac	127~250 Vdc
Input Frequency	47 Hz	-	63 Hz	
Leakage Current	-	-	0.75 MIU	UL8750; 277Vac/ 60Hz
	-	-	0.70 mA	IEC60598-1; 240Vac/ 60Hz,
Input AC Current	-	-	2.0 A	Measured at 100% load and 120Vac input.
	-	-	1.1 A	Measured at 100% load and 220Vac input.
Inrush Current(I <sup>2</sup> t)	-	-	3.5 A <sup>2</sup> s	At 220Vac input 25°C cold start, duration= 1.54ms, 10%I <sub>pk</sub> -10%I <sub>pk</sub> . See Inrush Current Waveform for the details.

## Input Specifications(Continued)

Parameter	Min.	Typ.	Max.	Notes
PF	0.90	-	-	At 100-277Vac, 50-60Hz, 70%-100% Load (134.4-192W)
THD	-	-	20%	
THD	-	-	10%	At 220-240Vac, 50-60Hz, 75%-100% Load (144-192W)

## Output Specifications

Parameter	Min.	Typ.	Max.	Notes
Output Channel	-	2	-	
Output Current Tolerance	-5%loset	-	5%loset	At 100% load condition
Output Current Setting(loset) Range				
EUG-192D105DT	70 mA	-	1050 mA	
EUG-192D265DT	175 mA	-	2650 mA	
EUG-192D400DT	265 mA	-	4000 mA	
Output Current Setting Range with Constant Power				
EUG-192D105DT	700 mA	-	1050 mA	
EUG-192D265DT	1750 mA	-	2650 mA	
EUG-192D400DT	2650 mA	-	4000 mA	
Total Output Current Ripple (pk-pk)	-	5%lomax	10%lomax	At 100% load condition, 20 MHz BW
Output Current Ripple at < 200 Hz (pk-pk)	-	2%lomax	-	At 100% load condition. Only this component of ripple is associated with visible flicker.
Startup Overshoot Current	-	-	10%lomax	At 100% load condition
No Load Output Voltage				
EUG-192D105DT	-	-	160 V	
EUG-192D265DT	-	-	60 V	
EUG-192D400DT	-	-	50 V	
Line Regulation	-	-	±0.5%	Measured at 100% load
Load Regulation	-	-	±1.5%	
Turn-on Delay Time	-	-	0.75 s	Measured at 120Vac input, 70%-100% Load
	-	-	0.5 s	Measured at 220Vac input, 70%-100% Load
Temperature Coefficient of Io	-	0.03%/°C	-	Case temperature = 0°C ~Tc max
12V Auxiliary Output Voltage	10.8 V	12 V	13.2 V	
12V Auxiliary Output Source Current	0 mA	-	20 mA	Return terminal is "Dim"

**Note:** All specifications are typical at 25 °C unless stated otherwise.

## General Specifications

Parameter	Min.	Typ.	Max.	Notes			
Efficiency at 120 Vac input: EUG-192D105DT I <sub>o</sub> = 700mA I <sub>o</sub> =1050mA EUG-192D265DT I <sub>o</sub> =1750mA I <sub>o</sub> =2650mA EUG-192D400DT I <sub>o</sub> =2650mA I <sub>o</sub> =4000mA	87.0% 86.5% 86.0% 85.0% 86.0% 84.0%	89.0% 88.5% 88.0% 87.0% 88.0% 86.0%	- - - - - -	Measured at 100% load and steady-state temperature in 25°C ambient; (Efficiency will be about 2.0% lower if measured immediately after startup.)			
Efficiency at 220 Vac input: EUG-192D105DT I <sub>o</sub> = 700mA I <sub>o</sub> =1050mA EUG-192D265DT I <sub>o</sub> =1750mA I <sub>o</sub> =2650mA EUG-192D400DT I <sub>o</sub> =2650mA I <sub>o</sub> =4000mA	90.0% 89.5% 89.0% 88.0% 89.0% 87.0%	92.0% 91.5% 91.0% 90.0% 91.0% 89.0%	- - - - - -		Measured at 100% load and steady-state temperature in 25°C ambient; (Efficiency will be about 2.0% lower if measured immediately after startup.)		
Efficiency at 277 Vac input: EUG-192D105DT I <sub>o</sub> = 700mA I <sub>o</sub> =1050mA EUG-192D265DT I <sub>o</sub> =1750mA I <sub>o</sub> =2650mA EUG-192D400DT I <sub>o</sub> =2650mA I <sub>o</sub> =4000mA	90.0% 90.0% 89.5% 89.0% 89.0% 87.5%	92.0% 92.0% 91.5% 91.0% 91.0% 89.5%	- - - - - -			Measured at 100% load and steady-state temperature in 25°C ambient; (Efficiency will be about 2.0% lower if measured immediately after startup.)	
MTBF	-	267,000 Hours	-				Measured at 220Vac input, 80%Load and 25°C ambient temperature (MIL-HDBK-217F)
Lifetime	-	93,000 Hours	-				Measured at 220Vac input, 80%Load and 70°C case temperature; See lifetime vs. T <sub>c</sub> curve for the details
Operating Case Temperature for Safety T <sub>c_s</sub>	-40°C	-	+90°C				
Operating Case Temperature for Warranty T <sub>c_w</sub>	-40°C	-	+75°C	Case temperature for 7 years warranty. Please see Inventronics Warranty Statement for complete details.			
Storage Temperature	-40°C	-	+85°C	Humidity: 5% RH to 100% RH			
Dimensions Inches (L × W × H) Millimeters (L × W × H)	10.00 × 3.15 × 1.66 254 × 80 × 42			With mounting ear 11.07 × 3.15 × 1.66 281 × 80 × 42			
Net Weight	-	1750 g	-				

**Note:** All specifications are typical at 25 °C unless stated otherwise.

## Dimming Specifications

Parameter		Min.	Typ.	Max.	Notes
Absolute Maximum Voltage on the Vdim (+) Pin		-20 V	-	20 V	
Source Current on Vdim (+)Pin		200 $\mu$ A	300 $\mu$ A	450 $\mu$ A	Vdim(+) = 0 V
Dimming Output Range	EUG-192D105DT EUG-192D265DT EUG-192D400DT	10%loset	-	loset	700 mA $\leq$ loiset $\leq$ 1050 mA 1750 mA $\leq$ loiset $\leq$ 2650 mA 2650 mA $\leq$ loiset $\leq$ 4000 mA
	EUG-192D105DT EUG-192D265DT EUG-192D400DT	70 mA 175 mA 265 mA	-	loset	70 mA $\leq$ loiset < 700 mA 175 mA $\leq$ loiset < 1750 mA 265 mA $\leq$ loiset < 2650 mA
	Recommended Dimming Range for 0-5V	0 V	-	5 V	Dimming mode set to 0-5V in PC interface.
Recommended Dimming Range for 0-10V		0 V	-	10 V	Default 0-10V dimming mode with positive logic.
PWM_in High Level		3 V	-	10 V	Dimming mode set to PWM in PC interface.
PWM_in Low Level		-0.3 V	-	0.6 V	
PWM_in Frequency Range		200 Hz	-	2 KHz	
PWM_in Duty Cycle		1%	-	99%	

## Safety & EMC Compliance

Safety Category	Standard
UL/CUL	UL8750, UL1310, CAN/CSA-C22.2 No. 250.13, CAN/CSA-C22.2 No. 223-M91
CE	EN 61347-1, EN61347-2-13
KS	KS C 7655
EMI Standards	Notes
EN 55015 <sup>(1)</sup>	Conducted emission Test & Radiated emission Test
EN 61000-3-2	Harmonic current emissions
EN 61000-3-3	Voltage fluctuations & flicker
FCC Part 15 <sup>(1)</sup>	ANSI C63.4 Class B
	This device complies with Part 15 of the FCC Rules. Operation is subject to the following two conditions: [1] this device may not cause harmful interference, and [2] this device must accept any interference received, including interference that may cause undesired Operation.
EMS Standards	Notes
EN 61000-4-2	Electrostatic Discharge (ESD): 8 kV air discharge, 4 kV contact discharge
EN 61000-4-3	Radio-Frequency Electromagnetic Field Susceptibility Test-RS
EN 61000-4-4	Electrical Fast Transient / Burst-EFT
EN 61000-4-5	Surge Immunity Test: AC Power Line: Differential Mode 6 kV, Common Mode 10 kV <sup>(2)</sup>
EN 61000-4-6	Conducted Radio Frequency Disturbances Test-CS

## Safety & EMC Compliance(Continued)

EMS Standards	Notes
EN 61000-4-8	Power Frequency Magnetic Field Test
EN 61000-4-11	Voltage Dips
EN 61547	Electromagnetic Immunity Requirements Applies To Lighting Equipment

**Note:** (1) This LED driver meets the EMI specifications above, but EMI performance of a luminaire that contains it depends also on the other devices connected to the driver and on the fixture itself.

(2) To perform electric strength (hi-pot) testing, the “GDT ground disconnect” (nut and metal lock sheet) on the driver end-cap should be removed temporarily to prevent the internal gas discharge tube from conducting (as allowed by IEC 60598-1 Clause 10.2). After testing is completed, these items must be reinstalled to restore line-to-earth surge protection and secure the end cap.

## Derating

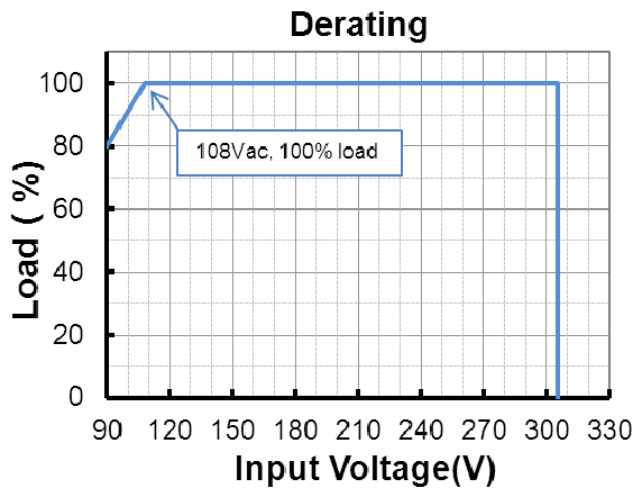

## Lifetime vs. Case Temperature

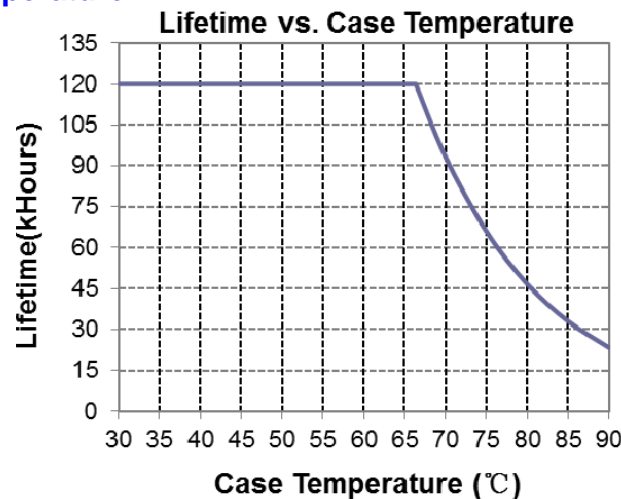

## Inrush Current Waveform

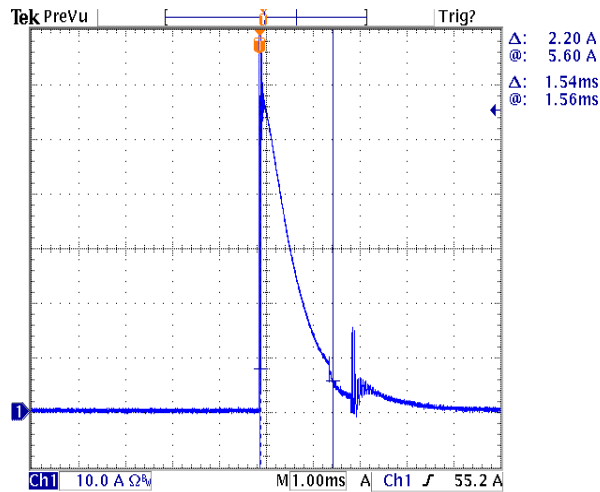

## Efficiency vs. Load

EUG-192D105DT (I<sub>o</sub>=700mA)  
Efficiency vs. Output Voltage

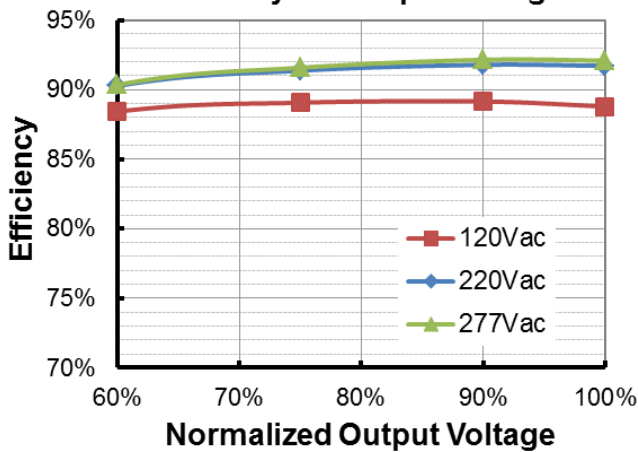

EUG-192D105DT (I<sub>o</sub>=1050mA)  
Efficiency vs. Output Voltage

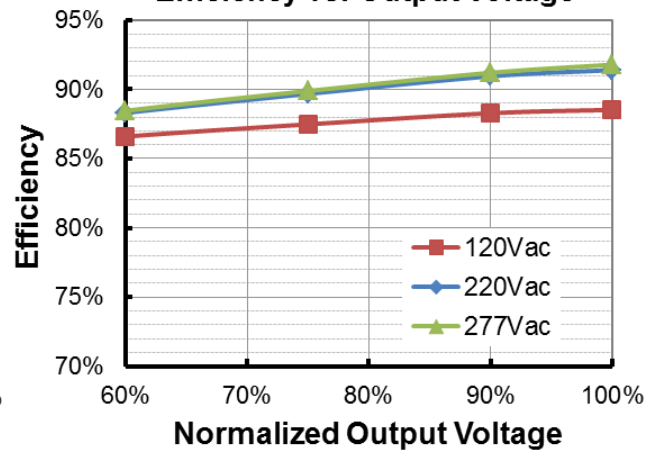

EUG-192D265DT (I<sub>o</sub>=1750mA)  
Efficiency vs. Output Voltage

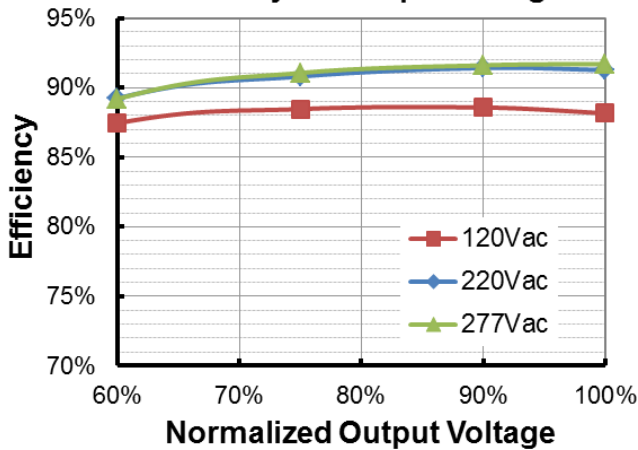

EUG-192D265DT (I<sub>o</sub>=2650mA)  
Efficiency vs. Output Voltage

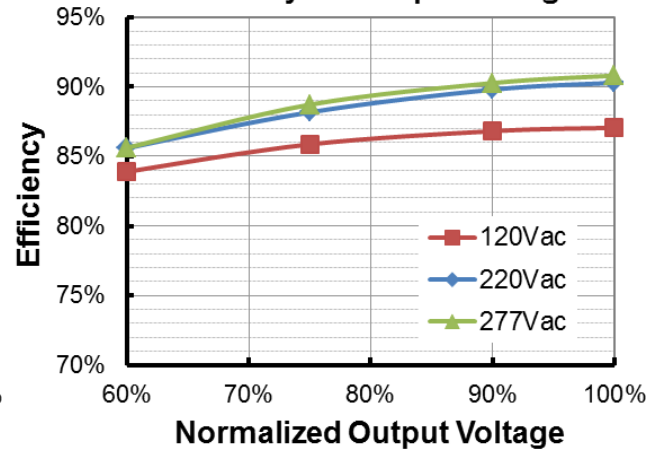

**EUG-192D400DT( $I_o=2650mA$ )  
Efficiency vs. Output Voltage**

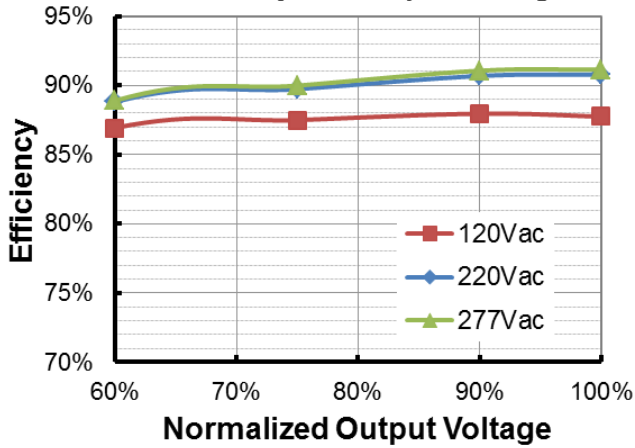

**EUG-192D400DT( $I_o=4000mA$ )  
Efficiency vs. Output Voltage**

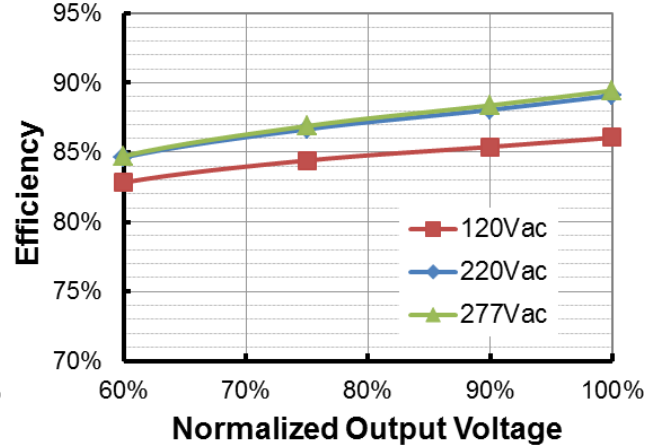

## Power Factor

**PF vs. Load**

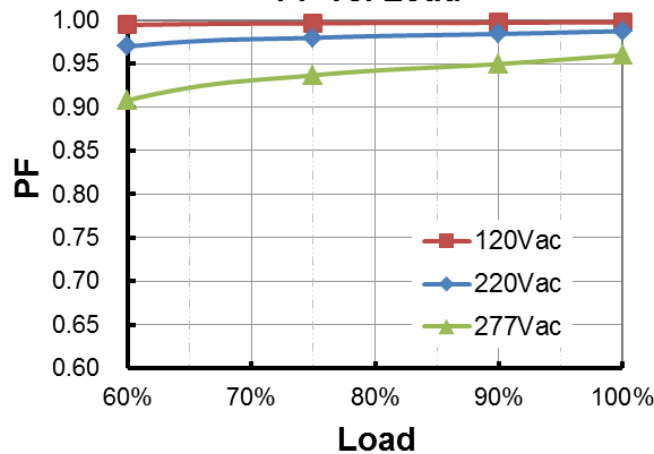

## Total Harmonic Distortion

**THD vs. Load**

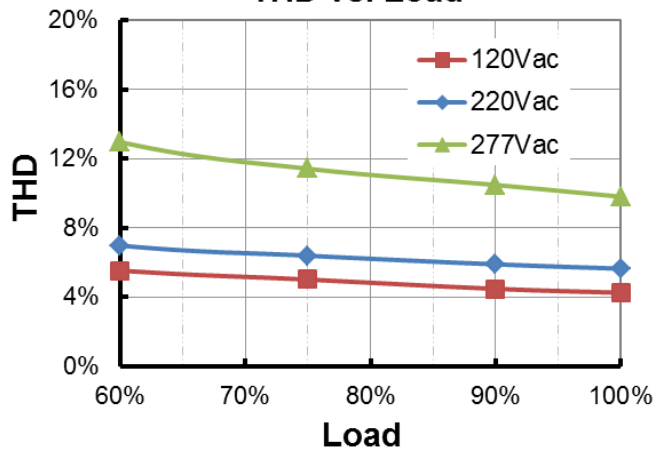



## Protection Functions

Parameter	Notes
Input Under Voltage Protection	Auto Recovery. Turn off the output when the input voltage falls below $75V \pm 10V$ . And the driver will restart when the input voltage is in normal.
Over Temperature Protection	Decreases output current, returning to normal after over temperature is removed.
Short Circuit Protection	Auto Recovery. No damage will occur when any output is short circuited. The output shall return to normal when the fault condition is removed.
Over Voltage Protection	Limits output voltage at no load and in case the normal voltage limit fails.

## Dimming

### ● 0-5V Dimming

The recommended implementation of the dimming control is provided below.

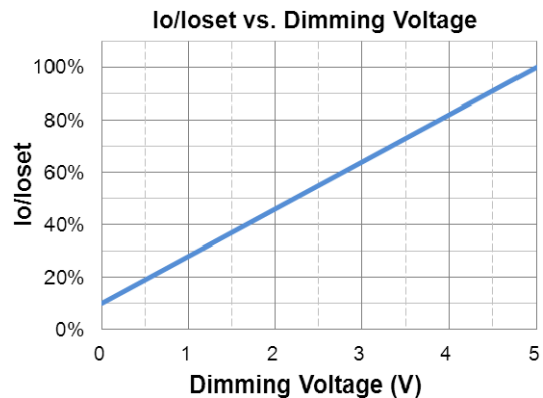
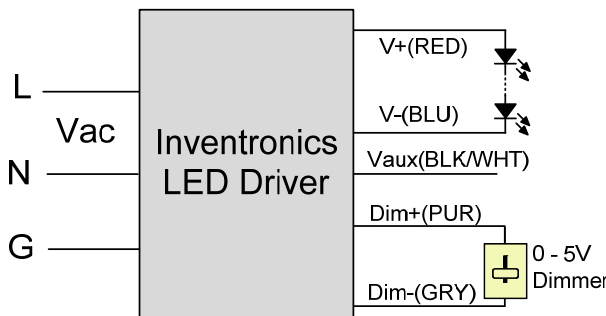

### Implementation 1: Positive logic

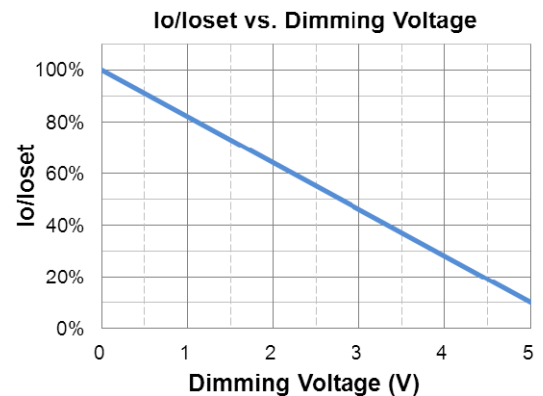
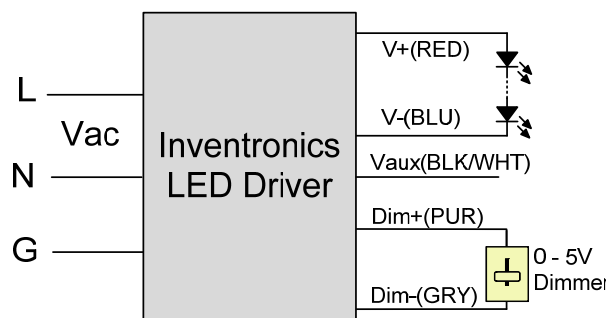

### Implementation 2: Negative logic

#### Notes:

1. The dimmer can also be replaced by an active 0-5V voltage source signal or passive components like resistors and zener.
2. Do NOT connect Dim- to the output V- or V+, otherwise the driver will not work properly.
3. If 0-5V dimming is not used, Dim + should be open.
4. When 0-5V negative logic dimming mode and Dim+ is open, the driver will output maximum current.

## ● 0-10V Dimming

The recommended implementation of the dimming control is provided below.

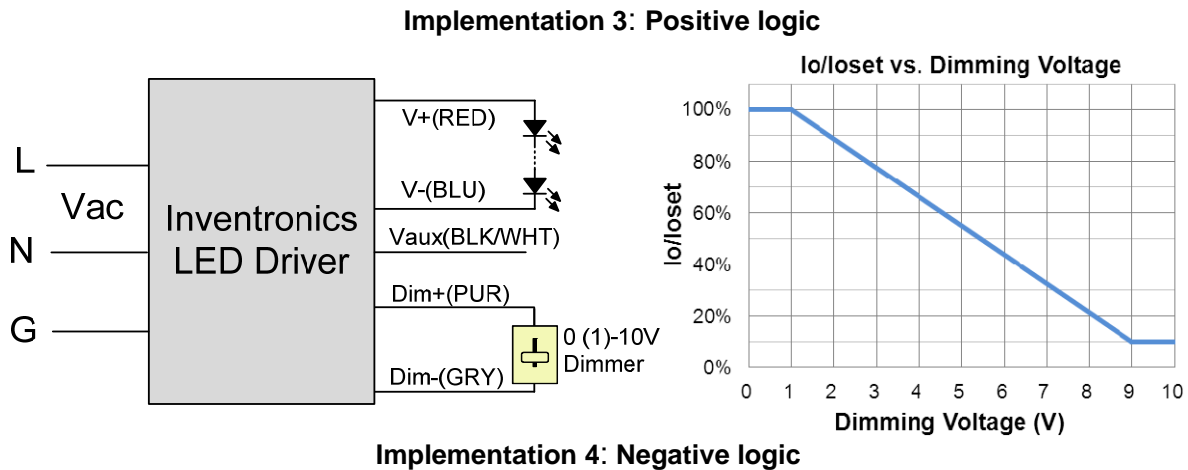
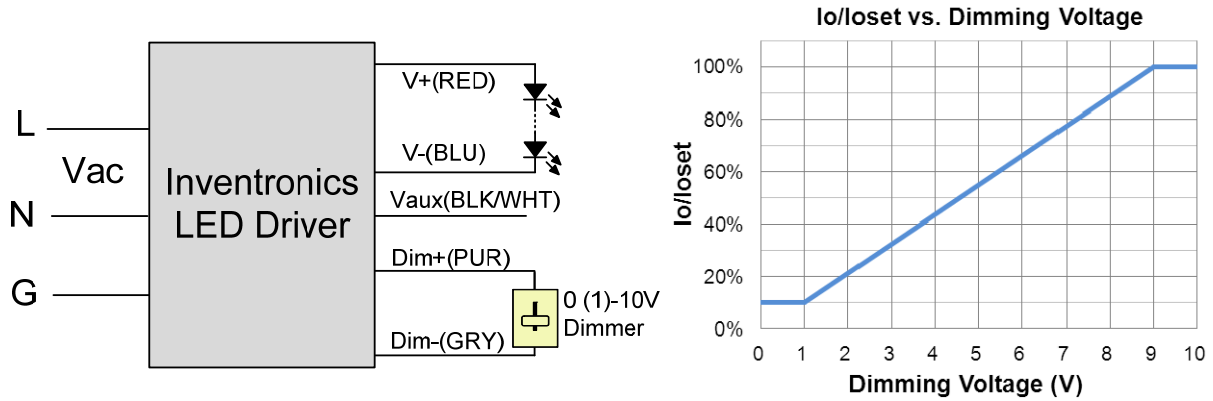

### Notes:

1. The dimmer can also be replaced by an active 0-10V voltage source signal or passive components like resistors and zener.
2. Do NOT connect Dim- to the output V- or V+, otherwise the driver will not work properly.
3. If 0-10V dimming is not used, Dim + should be open.
4. When 0-10V negative logic dimming mode and Dim+ is open, the driver will output minimum current.

## ● PWM Dimming

The recommended implementation of the dimming control is provided below.

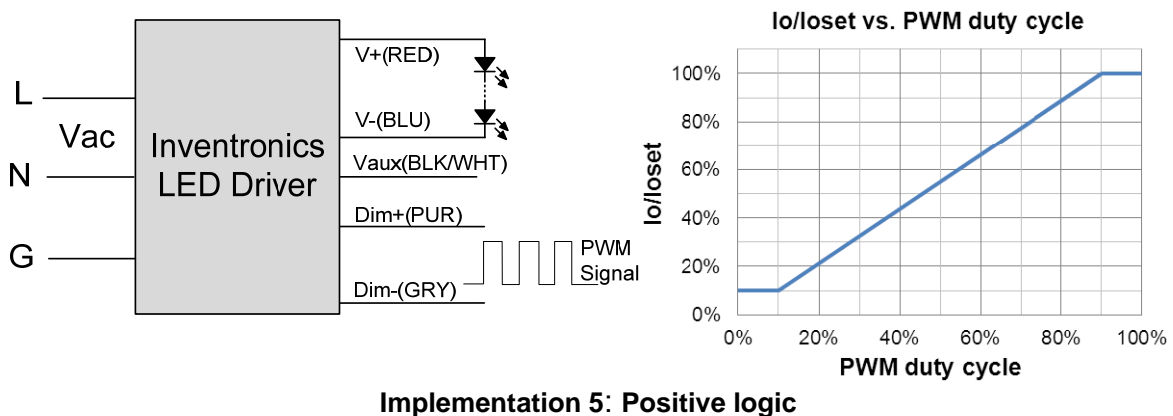

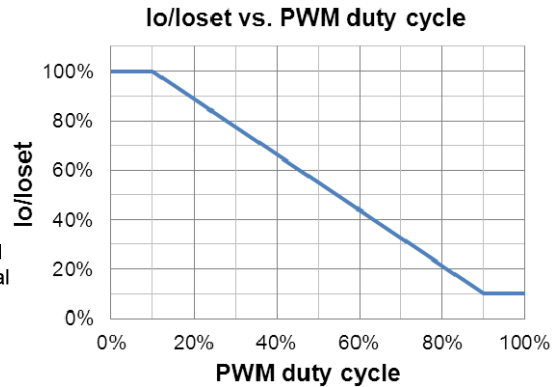
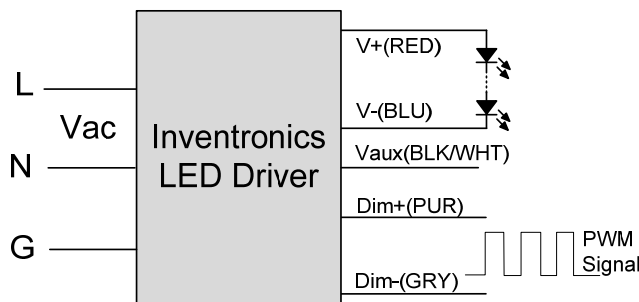

### Implementation 6: Negative logic

**Notes:**

1. Do NOT connect Dim- to the output V- or V+, otherwise the driver will not work properly.
2. If PWM dimming is not used, Dim + should be open.
3. When PWM negative logic dimming mode and Dim+ is open, the driver will output minimum current.

● **Time Dimming**

Time dimming control includes 3 kinds of modes, they are Self Adapting-Midnight, Self Adapting-Percentage and Traditional Timer.

- **Self Adapting-Midnight:** Automatically adjusts the dimming curve based on the on-time of past two days (if difference <15 minutes), assuming that the center point of the dimming curve is midnight local time.
- **Self Adapting-Percentage:** Automatically adjusts the on-time of each step by a constant percentage = (actual on-time for the past 2 days if difference <15 min) / (programmed on-time from the dimming curve).
- **Traditional Timer:** Follows the programmed timing curve after power on with no changes.

### Programming Connection Diagram

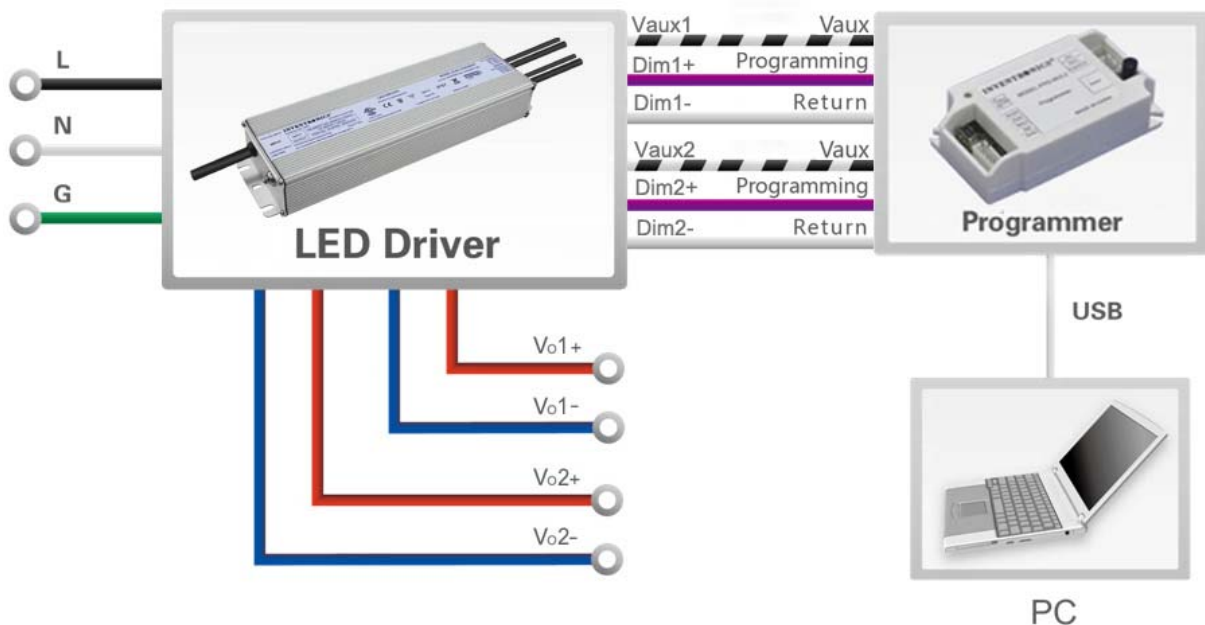

**Note:** The driver does not need to be powered on during the programming process.

- Please refer to [PRG-MUL2](#) Multi-Programmer datasheet for details.

## Mechanical Outline

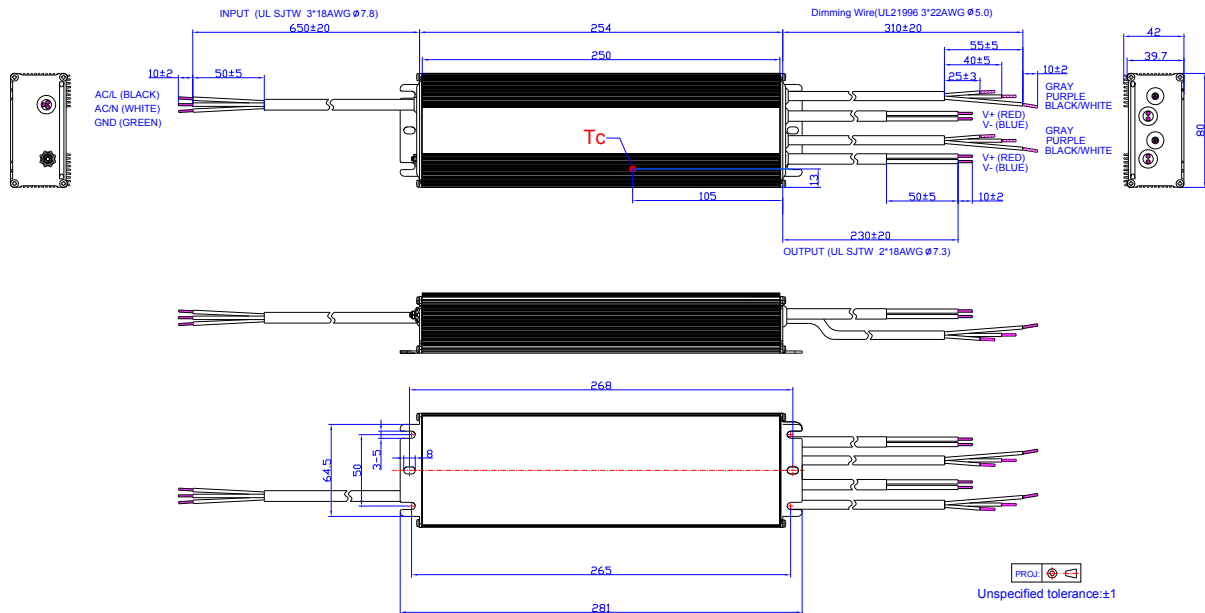

## RoHS Compliance

Our products comply with reference to RoHS Directive (EU) 2015/863 amending 2011/65/EU, calling for the elimination of lead and other hazardous substances from electronic products.

## Revision History

Change Date	Rev.	Description of Change		
		Item	From	To
2018-06-22	A	Datasheets Release	/	/
2019-12-02	B	Features	Timer Dimmable (3 Timer Modes)	3-Timer-Modes Dimmable
		Features	6kV line-line, 10kV line-earth	DM 6kV, CM 10kV
		Features	Waterproof (IP67)	IP67
		Features	5 Years Warranty	7 Years Warranty
		Models—Typical Efficiency (3)	91.5%	91.0%
		General Specifications	Operating Case Temperature for Warranty Tc_w -Notes	Updated
		Safety &EMC Compliance	EN 61000-4-5	Updated
		RoHS Compliance	/	Updated