



Advance Xtitanium linear LED drivers are designed to provide OEMs with ultimate flexibility. These models are compatible with standard 0-10V dimming systems to deliver reliably smooth dimming performance down to a minimum of 10%. These drivers offer the needed flexibility and performance for the application with precise tuning of drive currents, selectable dimming curves and adjustable minimum dimming levels. With wide operating windows, slim profile and simple current adjustability, luminaire manufacturers can easily design downlight fixtures with desired lumen levels to suit the application.

Specifications

Input Volt. (Vac)	Output Power (W)	Output Voltage (V)	Output Current (A)	Efficiency @ Max Load and 75°C Case	Max Case Temp. (°C)	Input Current (A)	Max. Input Power (W)	THD @ Max Load (%)	Power Factor @ Max Load	Surge Protect. (Combi Wave, KV)	Envir. Protect. Rating	Dim.	Dim. Range	Min. Output Current (A)	Other Comments	Driver Type
120	126 (2x63)	30 - 50	1.29	88.50	Life - 85°C UL - 90°C	1.22	150	<15%	>0.95	6	UL damp & dry, Type HL	0-10V Analog Class 2 Wiring	10% ~ 100%	0.129	Dimming source current: 150 µA	Constant Current
277		Class 2 Output		89.50		0.53										

Enclosure

	In. (mm)
Case Length	8.44 (214.4)
Case Width	2.35 (59.8)
Case Height	1.48 (37.6)
Mounting Length	8.91 (226.2)
Overall Length	9.47 (240.5)

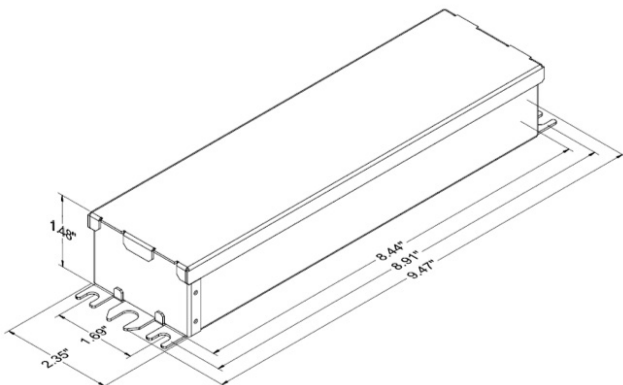

Wiring Diagram

Dimming	Wire Length (mm)
Black (Line)	270 (± 30)
White (Neutral)	270 (± 30)
Red (Positive, LED Output)	270 (± 30)
Blue (Negative, LED output)	270 (± 30)
Violet (Positive, 0-10V)	270 (± 30)
Pink (Negative, 0-10V)	270 (± 30)

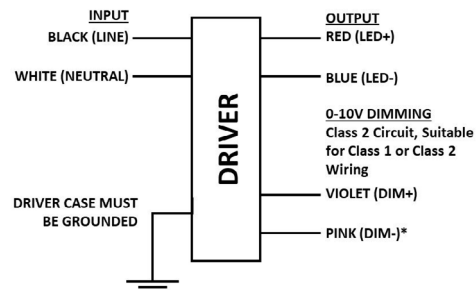

Warning

Install in accordance with national and local electrical codes. The field-wiring leads or push-in terminals shall be fully enclosed. For connections use wire rated for at least 90°C. Risk of fire or electric shock. Do not interconnect output terminations.

Grounding

Driver case must be grounded.



Xitanium XI126C129V050CNF2

126W 1.29A 2 channel 0-10V dimming

Features

- Driver solutions to cover 120-277V mains
- High efficiency – target 88.5%@120Vac and 89.5% @ 277Vac
- No programming necessary, fixed current, 0-10V dimming
- Class 2 output. Class P listing (UL, CSA, ETL)
- Tc 90°C max specification
- 6kV/3kA Surge rating – ANSI C82.77-5
- 2x63W driver (enabling up to 24klm)

Benefits

- Enables DLC premium system (high driver efficiency)
- High reliability and performance specifications
- Class 2 output to simplify isolation requirements
- Lowest system cost using low cost driver solution

Application

- Linear high-bay luminaires
 - > 2ft: 10k lumens up to 30k lumens
 - > 4ft: 30k lumens and up

Electrical Specifications

All the specifications are typical and at 25°C Ta unless specified otherwise.

Product Data

Order Information	
Full Product Code	XI126C129V050CNF2 (Mid-Pack, 12pcs/Box), 12NC: 929001759413
Line Frequency	50/60Hz
Min. Mains Voltage Operational	108 Vac
Max. Mains Voltage Operational	305 Vac
Output Information	
Maximum Open Circuit Voltage	< 60Vdc
Output Current Ripple (ripple = peak to average / average)	15% max. @ max. Iout
Output Current Tolerance (in the performance window)	<5%
Protections	Short Circuit and Open Circuit Protection for LED + and LED-, Overheat Protection
Features	
0-10V Dimming	150µA source current from driver. See dim curve for detail
AOC (adjustable output current)	n/a
Additional SimpleSet Configurable Features	n/a
Environment & Approbation	
Operating Ambient Temp. Range	-40°C to +60°C
Max. Case Temperature (Tcase)	85°C for Life and 90°C for UL Safety
Agency Approbations	UL 8750, NOM, cUL, Class P(UL, cUL)
Electromagnetic Compliance	FCC Title 47 Part 15 Class A
Audible Noise	<20dB Class A
Weight	1.76lb /0.8kg

1. Advance Xitanium LED drivers are manufactured to engineering standards correlating to a designed and average life expectancy of 50,000 hours of operation at maximum rated case temperature. Minimum 90% survivals based on MTTF modeling.

Xitanium XI126C129V050CNF2

126W 1.29A 2 channel 0-10V dimming

Electrical Specifications

All the specifications are typical and at 25°C Ta unless specified otherwise.

0-10V Dimming Curve

Dimming source current from the driver: 150µA (@ 0<Vdim<8V)

Minimum dim level: 10% of Iout (minimum 129mA)

Maximum output voltage on the dimming wires: 12V

Control Lead Leakage Current: 0.01mA, recommend max number of control circuits in parallel refer to Design-in Guide

Approved Dimmer List

Manufacturer	Manufacturer Part Number
Lutron	Visit www.lutron.com/advance for a list of dimmers (Mark VII) that will work with this driver
Leviton	IllumaTech IP7 series
Advance	Sunrise - SR1200ZTUNV

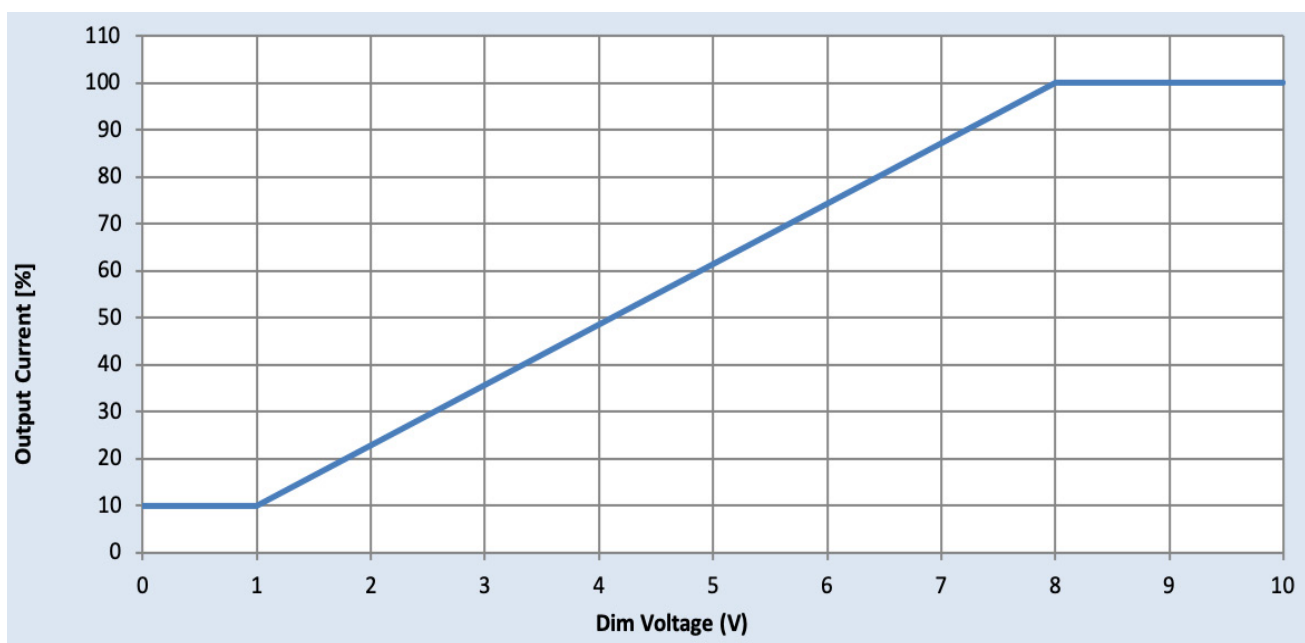

Xitanium XI126C129V050CNF2

126W 1.29A 2 channel 0-10V dimming

Electrical Specifications

All the specifications are typical and at 25°C Ta unless specified otherwise.

Driver Output Window

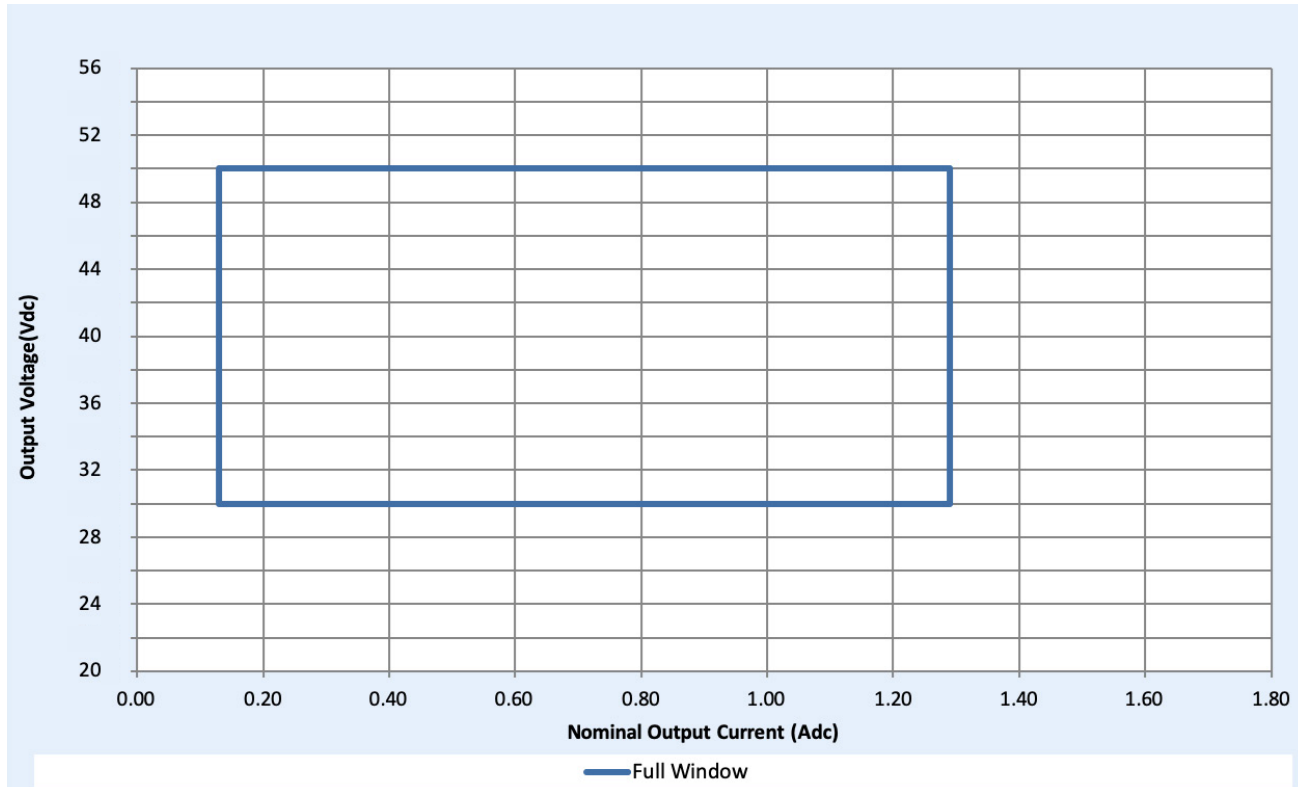

Xitanium XI126C129V050CNF2

126W 1.29A 2 channel 0-10V dimming

Electrical Specifications

All the specifications are typical and at 25°C Ta unless specified otherwise.

Output Current Vs. Driver Case Temperature

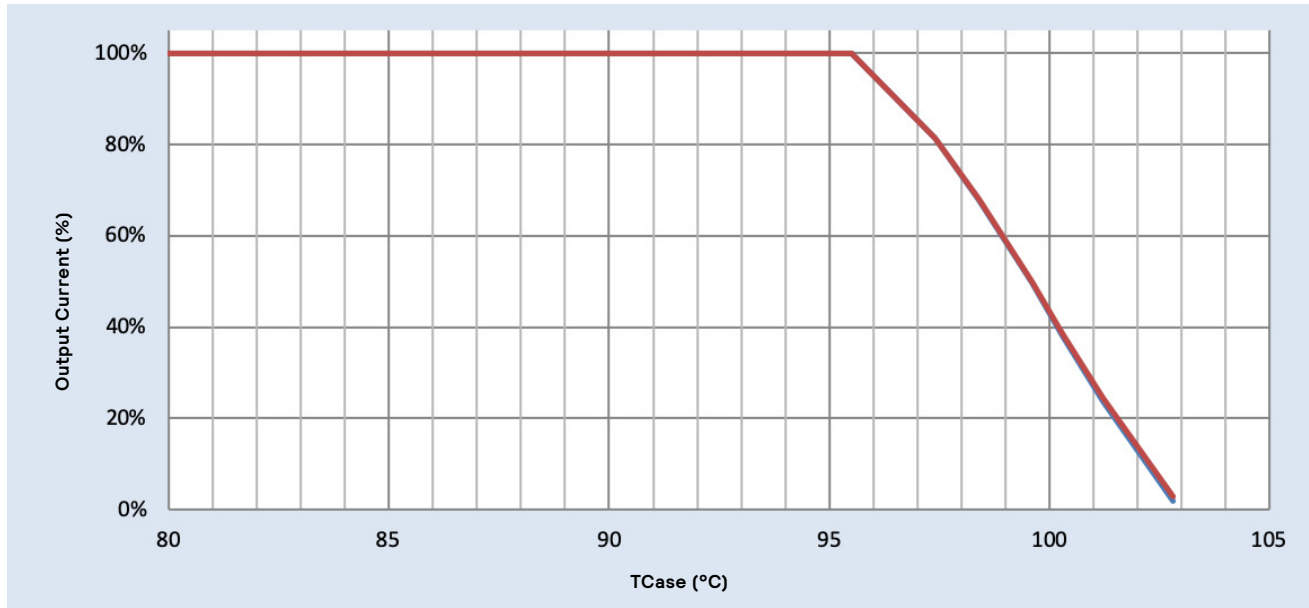

Driver Lifetime Vs. Driver Case Temperature

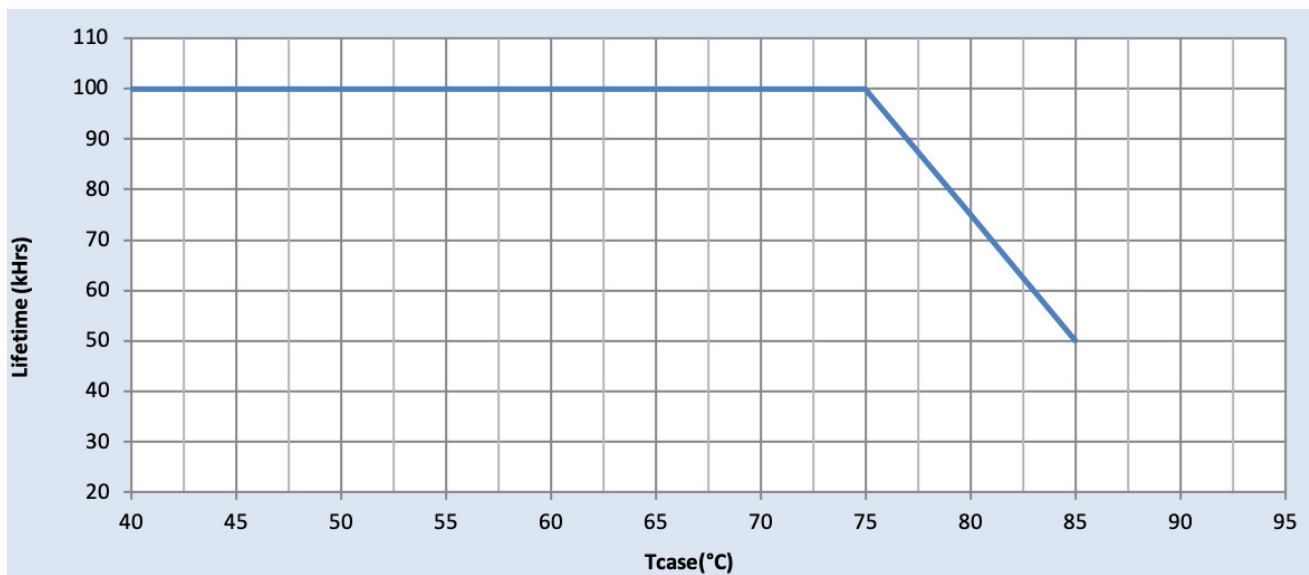

Xitanium XI126C129V050CNF2

126W 1.29A 2 channel 0-10V dimming

Performance Characteristics

Based on measurements on a typical sample at 90°C T case. The accuracy of the measurements is within the tolerance of the measurement instruments.

Efficiency Vs. Output Power at 120Vac

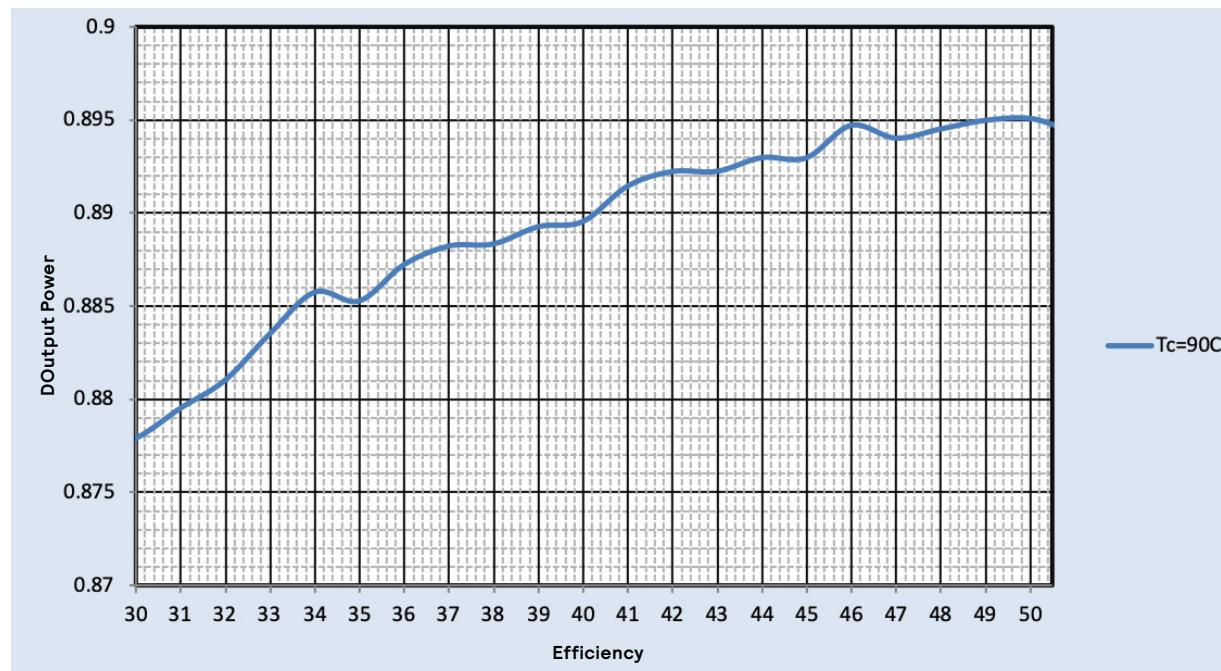

Efficiency Vs. Output Voltage at 277Vac

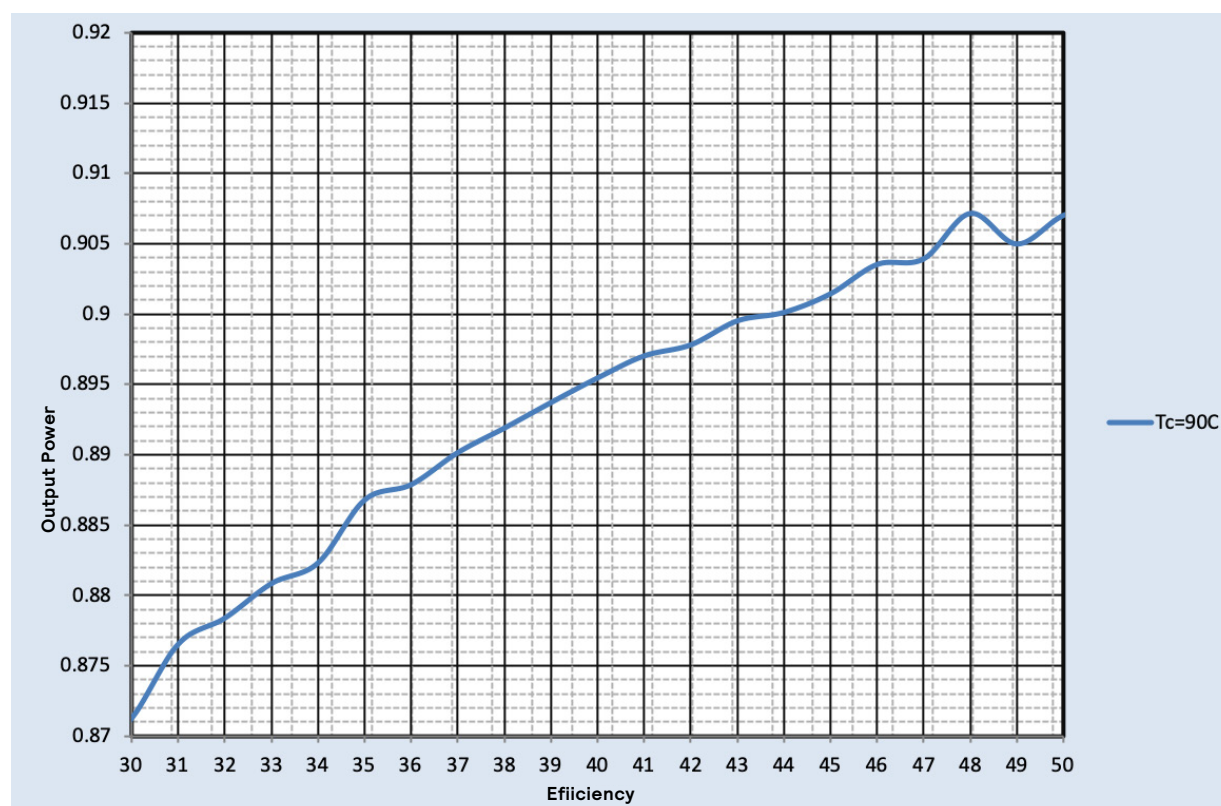

Xitanium XI126C129V050CNF2

126W 1.29A 2 channel 0-10V dimming

Performance Characteristics

Based on measurements on a typical sample at 90°C T case. The accuracy of the measurements is within the tolerance of the measurement instruments.

Power Factor Vs. Output Power

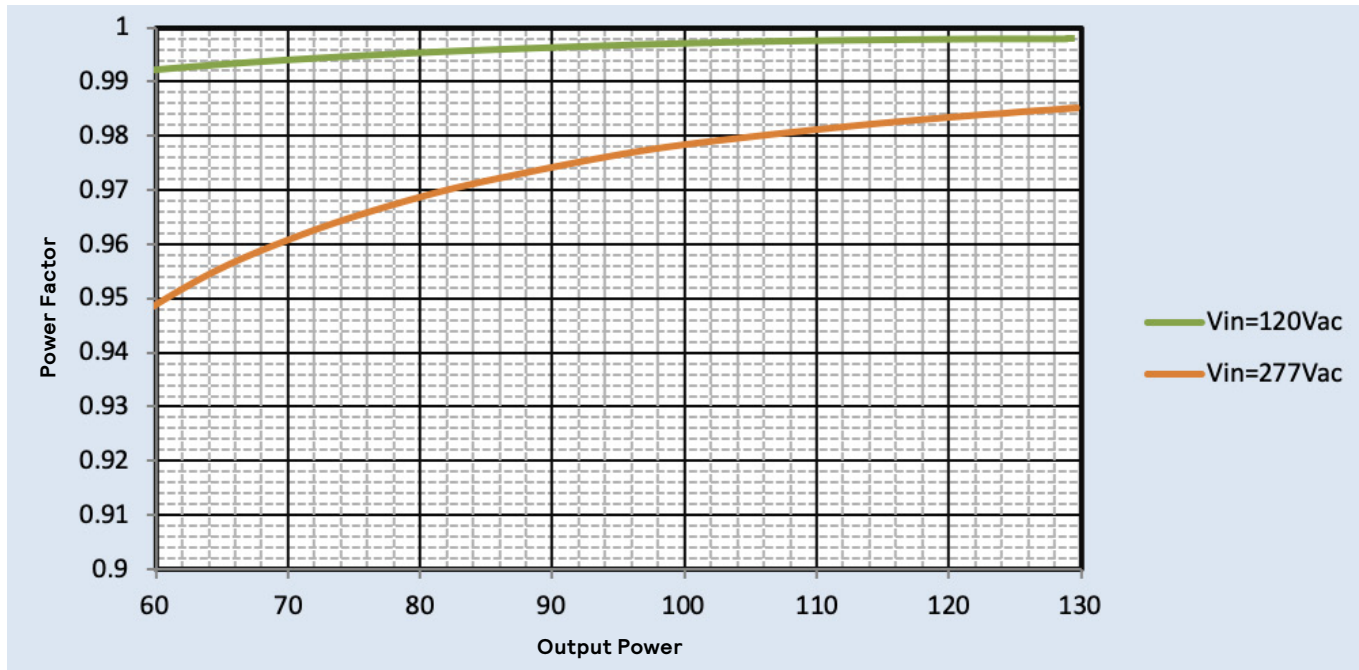

Total Harmonic Distortion (THD) Vs. Output Power

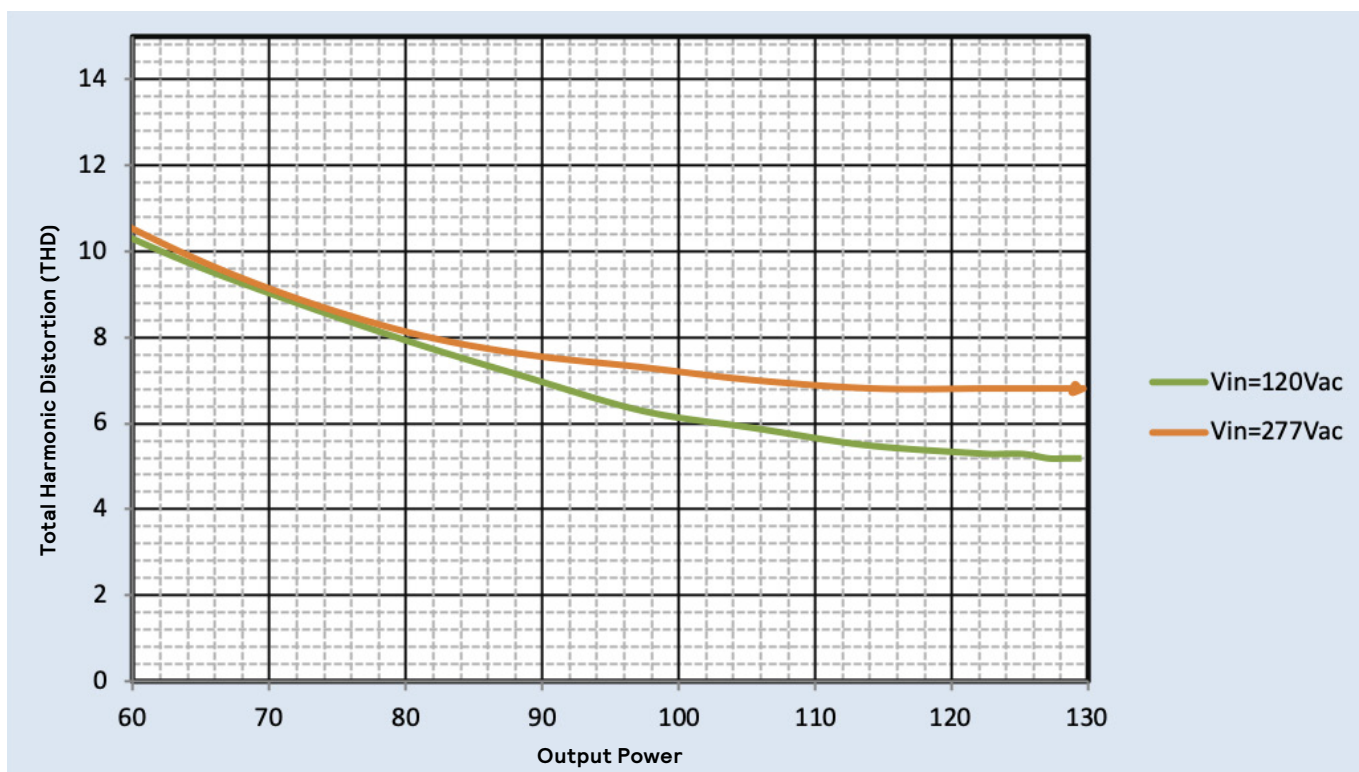

Xitanium XI126C129V050CNF2

126W 1.29A 2 channel 0-10V dimming

Inrush Current Info

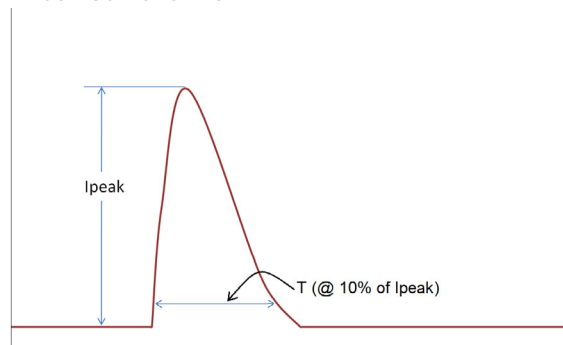

V_{in}	I_{peak}	T (@ 10% of I_{peak})
120 Vrms	60A	223 μ S
277 Vrms	95A	211 μ S

Inrush current is measured at peak of the corresponding line voltage. Source impedance per NEMA 410.

Lightning Surge Info

ANSI Surge Type	Differential Mode (L-N)	Common Mode (L-G, N-G, L&N-G)
100kHz Ring Wave (w/t 30 Ω)	6KV	6KV

Isolation

Isolation	Input	Output	0-10V	Enclosure
Input	-	2xU+1kV	2.5kV	2xU+1kV
Output	2xU+1kV	-	2.5kV	2xU+1kV
0-10V (Class 2)	2.5kV	2.5kV	-	2.5kV
Enclosure	2xU+1kV	2xU+1kV	2.5kV	-

U = Max. working voltage

