

## LED LAY IN FRAME PANEL - CCT & WATTAGE SELECTABLE 1X4', 2X2', 2X4'

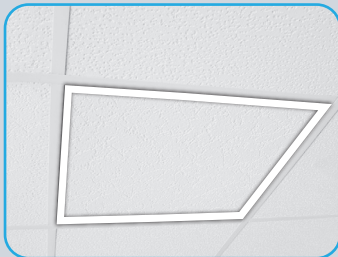

FRAME PANEL IN USE

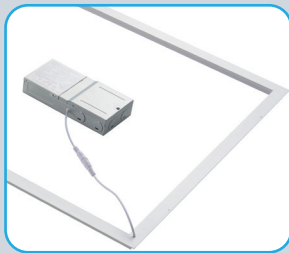

DRIVER WITH CCT & WATTAGE SELECT SWITCH

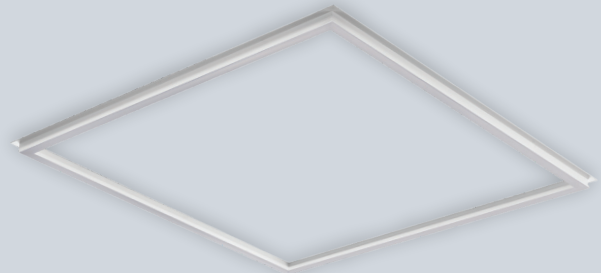

2X2'

20W | 30W | 40W

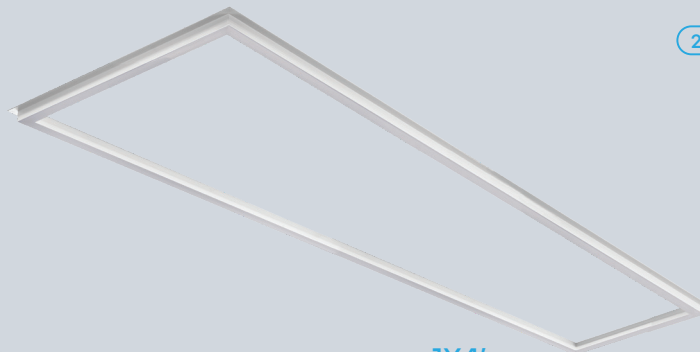

1X4'

20W | 30W | 40W

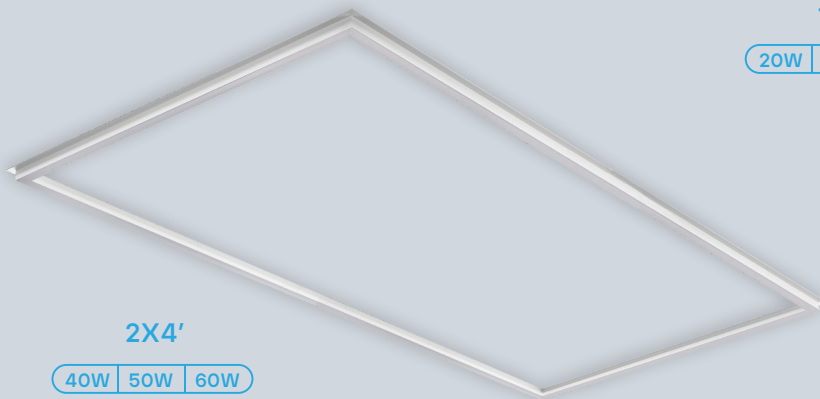

2X4'

40W | 50W | 60W

EMERGENCY OPTION  
OPTION ALSO AVAILABLE

LR24164+EM  
LR24166+EM



COLOR SELECTABLE

3000K | 3500K | 4000K | 5000K | 6500K

WATTAGE  
SELECTABLE

3 OPTIONS

DIMMABLE

0-10V



\*OPTION  
AVAILABLE



DAMP  
LOCATION  
RATED



IP RATING  
IP-40



5  
YEAR  
WARRANTY

## ELECTRICAL

	MODEL	DESCRIPTION	POWER	INPUT VOLTS	EFFICACY	LIFETIME	COST/YR	EMERGENCY TIME
1x4'	LR24168	LED1X4FRAME/PNL/3WO/5CCT/D	20	100-277V	130	50,000	\$ 4.81	
			30					
			40					
2x2'	LR24164	LED2X2FRAME/PNL/3WO/5CCT/D	20	100-277V	130	50,000	\$ 4.81	
			30					
			40					
2x2'	LR24164+EM	LED2X2FRAME/PNL/3WO/5CCT/D+EM	20	100-277V	130	50,000	\$ 4.81	90 MINS
			30					
			40					
2x4'	LR24166	LED2X4FRAME/PNL/3WO/5CCT/D	40	100-277V	130	50,000	\$ 7.22	
			50					
			60					
2x4'	LR24166+EM	LED2X4FRAME/PNL/3WO/5CCT/D+EM	40	100-277V	130	50,000	\$ 7.22	90 MINS
			50					
			60					

## PHOTOMETRIC

MODEL	DESCRIPTION	COLOR (CCT)	TEMP	LUMEN	FLOOD	CRI	ETL	DLC PREMIUM
LR24168	LED1X4FRAME/PNL/3WO/5CCT/D	3000K/3500K/4000K/5000K/6500K	CCT SELECT	2600 (@20W)	120°	80	YES	
				3900 (@30W)				
				5200 (@40W)				
LR24164	LED2X2FRAME/PNL/3WO/5CCT/D	3000K/3500K/4000K/5000K/6500K	CCT SELECT	2600 (@20W)	120°	80	YES	S-HMFKZ6
				3900 (@30W)				
				5200 (@40W)				
LR24164+EM	LED2X2FRAME/PNL/3WO/5CCT/D+EM	3000K/3500K/4000K/5000K/6500K	CCT SELECT	2600 (@20W)	120°	80	YES	S-HMFKZ6
				3900 (@30W)				
				5200 (@40W)				
LR24166	LED2X4FRAME/PNL/3WO/5CCT/D	3000K/3500K/4000K/5000K/6500K	CCT SELECT	5200 (@40W)	120°	80	YES	S-3MBR78
				6500 (@50W)				
				7800 (@60W)				
LR24166+EM	LED2X4FRAME/PNL/3WO/5CCT/D+EM	3000K/3500K/4000K/5000K/6500K	CCT SELECT	5200 (@40W)	120°	80	YES	S-3MBR78
				6500 (@50W)				
				7800 (@60W)				

COMPATIBLE WITH:

**LR35126**  
Emergency LED Driver



**LR24183**  
4' CABLE EXTENDER



## DIMENSIONS

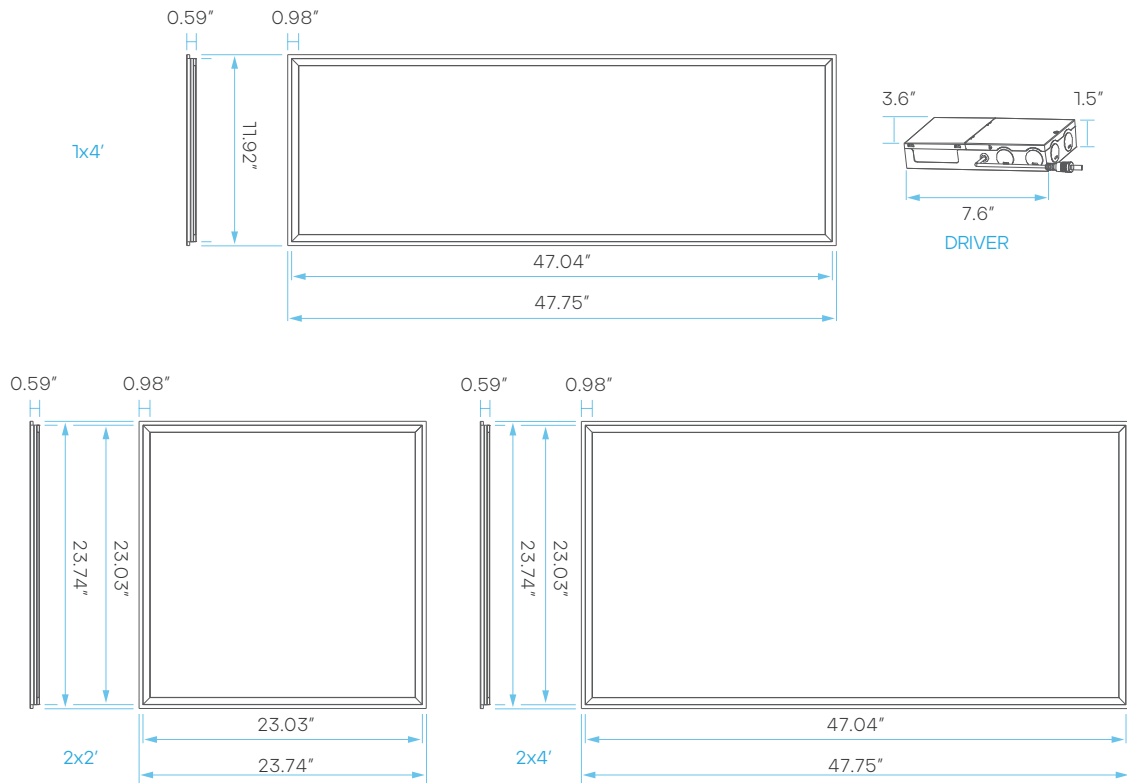

## 2X2 FRAME PANEL CANOPY

COMPATIBLE WITH LR24185

\*SOLD SEPARATELY

MODEL

DESCRIPTION

LR24184

LED2X2FRAME/PNL/CANOPY

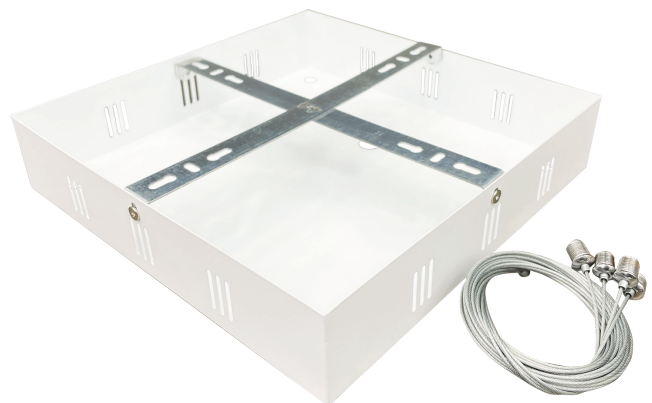



## LR35126 - SPECIFICATIONS

MODEL	DESCRIPTION	EM POWER	INPUT VOLTS	FREQUENCY	INPUT CURRENT	INPUT POWER	OUTPUT VOLTAGE	RECHARGE TIME	EMERGENCY TIME
LR35126	LED/EMR/15W/AC/SF/E	15	100-347V	50/60Hz	100mA	12W max	170V DC	24Hr	90min

AMBIENT TEMPERATURE: 41°F ~ 122°F

## LR35126 - WIRING DIAGRAM

1. For LED luminaires with 0-10V dimmable LED driver (\*LED Driver input power <100W) Emergency Driver Dim+ (Green), Driver Dim- (Yellow) has to connect with LED Driver DIM+ and DIM\_

