

## LED SPOTLIGHT CANLESS RECESSED GIMBAL - 5CCT SELECTABLE 2", 3", 4" - BLACK & WHITE

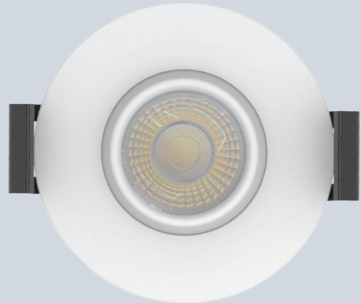

LR23300

2"

6W 400 LUMENS

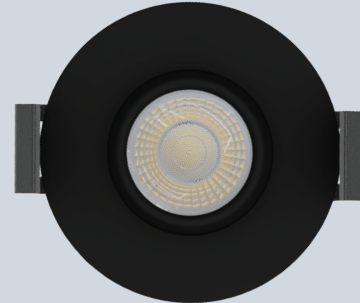

LR23301

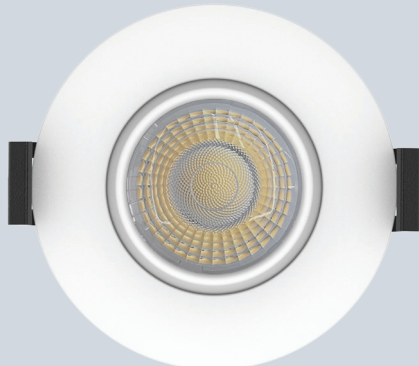

LR23302

3"

9W 730 LUMENS

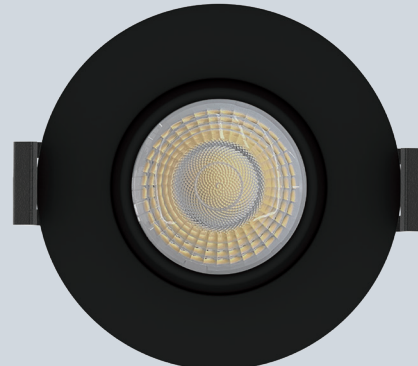

LR23303

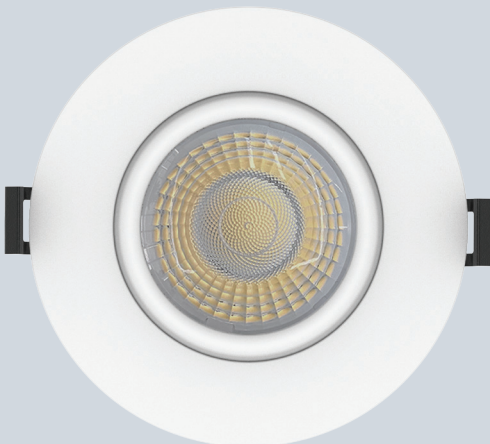

LR23304

4"

15W 1250 LUMENS

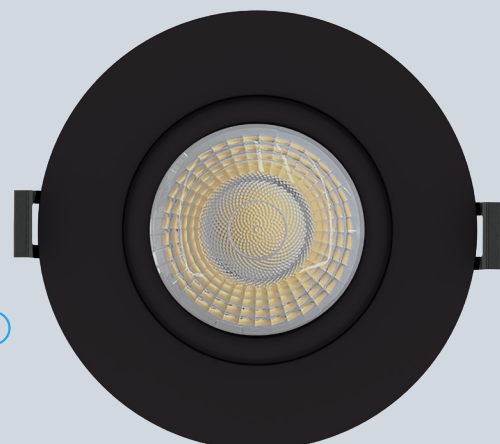

LR23305



COLOR SELECTABLE

2700K 3000K 3500K 4000K 5000K



## ELECTRICAL

	MODEL	DESCRIPTION	POWER	INPUT VOLTS	EFFICACY	DIMMABLE	FLOOD	LIFETIME	COST/YR
2"	WHITE LR23300	LED6W/DL2/GB/5CCT/RD/WT	6	120V	66	TRIAC	38°	50,000	\$ 0.72
	BLACK LR23301	LED6W/DL2/GB/5CCT/RD/BK	6	120V	66	TRIAC	38°	50,000	\$ 0.72
3"	WHITE LR23302	LED9W/DL3/GB/5CCT/RD/WT	9	120V	83	TRIAC	38°	50,000	\$ 1.08
	BLACK LR23303	LED9W/DL3/GB/5CCT/RD/BK	9	120V	83	TRIAC	38°	50,000	\$ 1.08
4"	WHITE LR23304	LED15W/DL4/GB/5CCT/RD2/WT	15	120V	83	TRIAC	38°	50,000	\$1.80
	BLACK LR23305	LED15W/DL4/GB/5CCT/RD2/BK	15	120V	83	TRIAC	38°	50,000	\$1.80

## PHOTOMETRIC

MODEL	DESCRIPTION	COLOR (CCT)	TEMP	LUMEN	CRI	ETL	TITLE 24	ENERGY STAR	PLATE (KNOCKOUT)
LR23300	LED6W/DL2/GB/5CCT/RD/WT	2700K/3000K/3500K/4000K/5000K	CCT SELECT	400	90	YES	YES		LR41004 (#0) LR41006 (#0) LR41010 (L0) LR41011 (#0)
LR23301	LED6W/DL2/GB/5CCT/RD/BK	2700K/3000K/3500K/4000K/5000K	CCT SELECT	400	90	YES	YES		
LR23302	LED9W/DL3/GB/5CCT/RD/WT	2700K/3000K/3500K/4000K/5000K	CCT SELECT	730	90	YES	YES	YES	
LR23303	LED9W/DL3/GB/5CCT/RD/BK	2700K/3000K/3500K/4000K/5000K	CCT SELECT	730	90	YES	YES	YES	LR41002 (#0) LR41006 (#1)
LR23304	LED15W/DL4/GB/5CCT/RD2/WT	2700K/3000K/3500K/4000K/5000K	CCT SELECT	1250	90	YES	YES	YES	LR41002 (#1) LR41006 (#3) LR41010 (R1) LR41011 (#4)
LR23305	LED15W/DL4/GB/5CCT/RD2/BK	2700K/3000K/3500K/4000K/5000K	CCT SELECT	1250	90	YES	YES	YES	

## COMPATIBILITY

COMPATIBLE WITH:

**LR35126**  
Emergency LED Driver



**LR41004**  
New Construction Mounting Plate

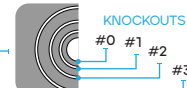

KNOCKOUT SIZE	
#0	Ø2.125" (Ø54 mm)
#1	Ø2.83" (Ø72 mm)
#2	Ø3.75" (Ø95 mm)
#3	Ø5.19" (Ø132 mm)

**LR41006**  
New Construction Mounting Plate

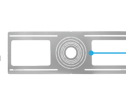

KNOCKOUT SIZE	
#0	Ø2.12" (Ø54 mm)
#1	Ø3.15" (Ø80 mm)
#2	Ø3.75" (Ø95 mm)
#3	Ø4.25" (Ø108 mm)
#4	Ø5.25" (Ø132 mm)
#5	Ø6.25" (Ø159 mm)

**LR41011**  
New Construction Mounting Plate

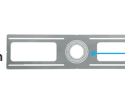

KNOCKOUT SIZE	
#0	Ø2.48" (Ø63 mm)
#1	Ø2.83" (Ø72 mm)
#2	Ø3.34" (Ø85 mm)
#3	Ø3.74" (Ø95 mm)
#4	Ø4.25" (Ø108 mm)

**LR41002**  
New Construction Mounting Plate

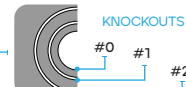
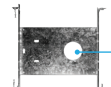

KNOCKOUT SIZE	
#0	Ø3.14" (Ø80 mm)
#1	Ø4.33" (Ø110 mm)
#2	Ø6.29" (Ø160 mm)

**LR41010**  
New Construction Mounting Plate



KNOCKOUT SIZE	
#L0	Ø2.12" (Ø54 mm)
#L1	Ø2.83" (Ø72 mm)
#L2	Ø3.75" (Ø95 mm)

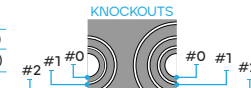

KNOCKOUT SIZE	
#R0	Ø3.25" (Ø82 mm)
#R1	Ø4.33" (Ø110 mm)
#R2	Ø5.25" (Ø132 mm)
#R3	Ø6.25" (Ø160 mm)

## DIMENSIONS

2"  
CUTOUT: Ø 2.16"

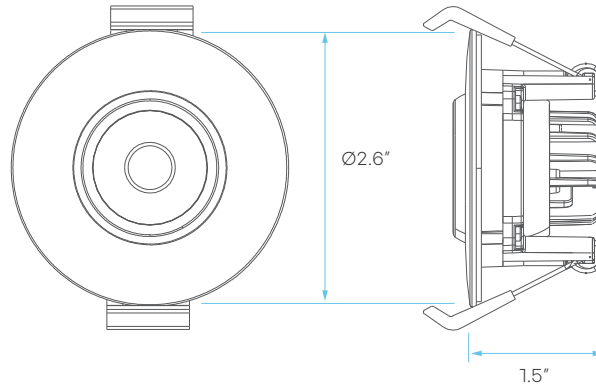

3"  
CUTOUT: Ø3"

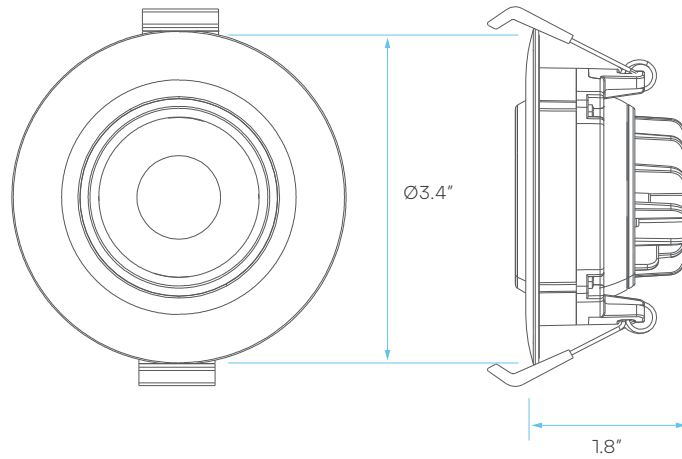

4"  
CUTOUT: Ø4.31"

