

LED Luminaires

ProLED Select Compact Linear High Bay Series

- Compact Design To Reduce Shipping Costs, and Reduce Installation Time
- Big performance, 12,000 to 45,000 Lumens in 3 sizes, 4 CCT Selectable SKUs
- Operates in Ambient Temperatures up to 50° C
- Frosted Acrylic Lens To Eliminate Glare

Specifications



Description

The Compact Linear High Bay (CLHB) is designed to meet the needs of the budget-conscious contractor. CLHB boasts robust performance in a smaller footprint to save space and cut down installation time. Designed with a durable die-cast aluminum housing and matte acrylic lens to eliminate glare, the CLHB is a reliable solution for light-duty industrial applications like warehouses, without sacrificing quality needed in retail stores, gymnasiums, and other large indoor spaces.

Performance

- Selectable color temperatures 4000K / 5000K
- 136+ lumens per watt
- 80+ CRI
- Built in 6kV surge protection
- 0-10V dimming
- 120-277VAC input
- 5 Year limited warranty

Construction

- Die-cast aluminum housing
- Acrylic, matte lens
- 1/2" Knock outs on top, sides and bottom
- Chain and v hook mount (standard)
- Wire guard, pendant mount, surface mount (accessories)
- Optional stepdown transformer
- Optional battery backup

Certifications

- DLC 5.1 Premium
- cULus
- UL
- ROHS compliant
- FCC
- Environmental rating IP20, UL damp location rating

Controls

- 0-10 VDC dimming standard
- RF bi-level occupancy sensing
- PIR bi-level occupancy sensing

ProLED Select Compact Linear High Bay Series

Ordering Logic

Series	Base Lumens	Wattage	CCT	Voltage	Options
CLHB = Compact Linear High Bay	1 = 12,010 Lumens 2 = 19,859 Lumens 3 = 25,540 Lumens 4 = 32,450 Lumens	WS = Wattage Selectable 1 (90W / 110W / 130W) 2 (140W / 150W / 165W) 3 (180W / 200W / 220W) 4 (240W / 280W / 320W)	CS = Color Selectable / 4000K/5000K	U = 120-277VAC H = 347-480VAC	EM = Battery Backup PIRMS = Side Mount PIR Occupancy Sensing

Ordering Information

Product SKU	Product Code	Product Description
36100	CLHB-1-WS-CS-U	ProLED Select Compact Linear High Bay Wattage Selectable (12,010-17,588 lumens, 90W-110W-130W) Color Selectable 4000K-5000K, Universal Voltage 120-277VAC with Chain and V Hook Mount
36101	CLHB-2-WS-CS-U	ProLED Select Compact Linear High Bay Wattage Selectable (19,859-23,736 lumens, 140W-150W-165W), Color Selectable 4000K-5000K, Universal Voltage 120-277VAC with Chain and V Hook Mount
36102	CLHB-3-WS-CS-U	ProLED Select Compact Linear High Bay Wattage Selectable (24,540-31,023 lumens, 180W-200W-220W), Color Selectable 4000K-5000K, Universal Voltage 120-277VAC with Chain and V Hook Mount
36103	CLHB-4-WS-CS-U	ProLED Select Compact Linear High Bay Wattage Selectable (32,450-45,237 lumens, 240W-280W-320W) Color Selectable 4000K-5000K, Universal Voltage 120-277VAC with Chain and V Hook Mount
Accessories		
24875*	DCMS	DC Bi-Level Motion Sensor
24975	DCMSPIR	DC Bi-Level PIR (Passive Infrared) Motion Sensor
24876	DCMS-REM	DC Bi-Level Motion Sensor Remote
99986	LHB/MC	(0-10V) Motion Control Sensor LSXR 610 HL - Side Knockout Install
36148	CLHB-1-A-WG	Wire Guard for CLHB-1
36149	CLHB-2-A-WG	Wire Guard for CLHB-2
36150	CLHB-34-A-WG	Wire Guard for CLHB- 3, CLHB-4
36151	CLHB-12-M-PEND	Pendant Mount for CLHB-1, CLHB-2
36152	CLHB-12-M-SURF	Surface Mount for CLHB-1, CLHB-2
36153	CLHB-34-M-PEND	Pendant Mount for CLHB-3 CLHB-4
36154	CLHB-34-M-SURF	Surface Mount for CLHB-3 CLHB-4
36155	CLHB-BBU-9	Battery Backup (9W/90Min) for CLHB
36156	CLHB-12-DR-480V	Driver (150W) 277-480VAC for CLHB-1 CLHB-2
36157	CLHB-3-DR-480V	Driver (200W) 277-480VAC for CLHB-3
36158	CLHB-4-DR-480V	Driver (320W) 277-480VAC for CLHB-4

*When using CLHB-BBU-9 or 16 and DCMS Motion Sensor, DCMS sensor must be set to ∞ standby time on the motion sensor remote. This setting allows fixture to not turn off in EM mode.

ProLED Select Compact Linear High Bay Series

Non Stock Product SKU	Product Code	Product Description
36106	CLHB-1-WS-CS-U-PIRMS	ProLED Select Compact Linear Highbay 1, Wattage Selectable 130W-110W-90W, Color Selectable 4000K-5000K, Universal Voltage 120-277VAC with Suspended Chain Mount with PIR Motion Sensor
36107	CLHB-1-WS-CS-U-EM	ProLED Select Compact Linear Highbay 1, Wattage Selectable 130W-110W-90W, Color Selectable 4000K-5000K, Universal Voltage 120-277VAC with Suspended Chain Mount with Emergency Battery Backup
36108	CLHB-1-WS-CS-U-EM-PIRMS	ProLED Select Compact Linear Highbay 1, Wattage Selectable 130W-110W-90W, Color Selectable 4000K-5000K, Universal Voltage 120-277VAC with Suspended Chain Mount with Emergency Battery Backup and PIR Motion Sensor
36109	CLHB-1-WS-CS-H	ProLED Select Compact Linear Highbay 1, Wattage Selectable 130W-110W-90W, Color Selectable 4000K-5000K, Universal Voltage 277-480VAC with Suspended Chain Mount
36110	CLHB-1-WS-CS-H-PIRMS	ProLED Select Compact Linear Highbay 1, Wattage Selectable 130W-110W-90W, Color Selectable 4000K-5000K, Universal Voltage 277-480VAC with Suspended Chain Mount with PIR Motion Sensor
36111	CLHB-1-WS-CS-H-EM	ProLED Select Compact Linear Highbay 1, Wattage Selectable 130W-110W-90W, Color Selectable 4000K-5000K, Universal Voltage 277-480VAC with Suspended Chain Mount with Emergency Battery Backup
36112	CLHB-1-WS-CS-H-EM-PIRMS	ProLED Select Compact Linear Highbay 1, Wattage Selectable 130W-110W-90W, Color Selectable 4000K-5000K, Universal Voltage 277-480VAC with Suspended Chain Mount with Emergency Battery Backup and PIR Motion Sensor
36113	CLHB-2-WS-CS-U-PIRMS	ProLED Select Compact Linear Highbay 2, Wattage Selectable 165W-150W-140W, Color Selectable 4000K-5000K, Universal Voltage 120-277VAC with Suspended Chain Mount with PIR Motion Sensor
36114	CLHB-2-WS-CS-U-EM	ProLED Select Compact Linear Highbay 2, Wattage Selectable 165W-150W-140W, Color Selectable 4000K-5000K, Universal Voltage 120-277VAC with Suspended Chain Mount with Emergency Battery Backup
36115	CLHB-2-WS-CS-U-EM-PIRMS	ProLED Select Compact Linear Highbay 2, Wattage Selectable 165W-150W-140W, Color Selectable 4000K-5000K, Universal Voltage 120-277VAC with Suspended Chain Mount with Emergency Battery Backup and PIR Motion Sensor
36116	CLHB-2-WS-CS-H	ProLED Select Compact Linear Highbay 2, Wattage Selectable 165W-150W-140W, Color Selectable 4000K-5000K, Universal Voltage 277-480VAC with Suspended Chain Mount
36117	CLHB-2-WS-CS-H-PIRMS	ProLED Select Compact Linear Highbay 2, Wattage Selectable 165W-150W-140W, Color Selectable 4000K-5000K, Universal Voltage 277-480VAC with Suspended Chain Mount with PIR Motion Sensor
36118	CLHB-2-WS-CS-H-EM	ProLED Select Compact Linear Highbay 2, Wattage Selectable 165W-150W-140W, Color Selectable 4000K-5000K, Universal Voltage 277-480VAC with Suspended Chain Mount with Emergency Battery Backup
36119	CLHB-2-WS-CS-H-EM-PIRMS	ProLED Select Compact Linear Highbay 2, Wattage Selectable 165W-150W-140W, Color Selectable 4000K-5000K, Universal Voltage 277-480VAC with Suspended Chain Mount with Emergency Battery Backup and PIR Motion Sensor
36120	CLHB-3-WS-CS-U-PIRMS	ProLED Select Compact Linear Highbay 3, Wattage Selectable 220W-200W-180W, Color Selectable 4000K-5000K, Universal Voltage 120-277VAC with Suspended Chain Mount with PIR Motion Sensor
36121	CLHB-3-WS-CS-U-EM	ProLED Select Compact Linear Highbay 3, Wattage Selectable 220W-200W-180W, Color Selectable 4000K-5000K, Universal Voltage 120-277VAC with Suspended Chain Mount with Emergency Battery Backup
36122	CLHB-3-WS-CS-U-EM-PIRMS	ProLED Select Compact Linear Highbay 3, Wattage Selectable 220W-200W-180W, Color Selectable 4000K-5000K, Universal Voltage 120-277VAC with Suspended Chain Mount with Emergency Battery Backup and PIR Motion Sensor
36123	CLHB-3-WS-CS-H	ProLED Select Compact Linear Highbay 3, Wattage Selectable 220W-200W-180W, Color Selectable 4000K-5000K, Universal Voltage 277-480VAC with Suspended Chain Mount
36124	CLHB-3-WS-CS-H-PIRMS	ProLED Select Compact Linear Highbay 3, Wattage Selectable 220W-200W-180W, Color Selectable 4000K-5000K, Universal Voltage 277-480VAC with Suspended Chain Mount with PIR Motion Sensor
36125	CLHB-3-WS-CS-H-EM	ProLED Select Compact Linear Highbay 3, Wattage Selectable 220W-200W-180W, Color Selectable 4000K-5000K, Universal Voltage 277-480VAC with Suspended Chain Mount with Emergency Battery Backup
36126	CLHB-3-WS-CS-H-EM-PIRMS	ProLED Select Compact Linear Highbay 3, Wattage Selectable 220W-200W-180W, Color Selectable 4000K-5000K, Universal Voltage 277-480VAC with Suspended Chain Mount with Emergency Battery Backup and IR Motion Sensor
36127	CLHB-4-WS-CS-U-PIRMS	ProLED Select Compact Linear Highbay 4, Wattage Selectable 320W-280W-240W, Color Selectable 4000K-5000K, Universal Voltage 120-277VAC with Suspended Chain Mount with PIR Motion Sensor
36128	CLHB-4-WS-CS-U-EM	ProLED Select Compact Linear Highbay 4, Wattage Selectable 320W-280W-240W, Color Selectable 4000K-5000K, Universal Voltage 120-277VAC with Suspended Chain Mount with Emergency Battery Backup
36129	CLHB-4-WS-CS-U-EM-PIRMS	ProLED Select Compact Linear Highbay 4, Wattage Selectable 320W-280W-240W, Color Selectable 4000K-5000K, Universal Voltage 120-277VAC with Suspended Chain Mount with Emergency Battery Backup and PIR Motion Sensor
36130	CLHB-4-WS-CS-H	ProLED Select Compact Linear Highbay 4, Wattage Selectable 320W-280W-240W, Color Selectable 4000K-5000K, Universal Voltage 277-480VAC with Suspended Chain Mount
36131	CLHB-4-WS-CS-H-PIRMS	ProLED Select Compact Linear Highbay 4, Wattage Selectable 320W-280W-240W, Color Selectable 4000K-5000K, Universal Voltage 277-480VAC with Suspended Chain Mount with PIR Motion Sensor
36132	CLHB-4-WS-CS-H-EM	ProLED Select Compact Linear Highbay 4, Wattage Selectable 320W-280W-240W, Color Selectable 4000K-5000K, Universal Voltage 277-480VAC with Suspended Chain Mount with Emergency Battery Backup
36133	CLHB-4-WS-CS-H-EM-PIRMS	ProLED Select Compact Linear Highbay 4, Wattage Selectable 320W-280W-240W, Color Selectable 4000K-5000K, Universal Voltage 277-480VAC with Suspended Chain Mount with Emergency Battery Backup and PIR Motion Sensor

ProLED Select Compact Linear High Bay Series

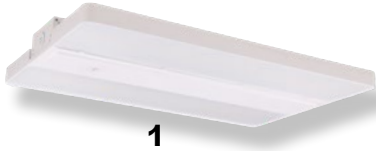

1



2



3, 4

Product Selector

Watts	Color Temp	Base Part # 120-277V	With DC Bi-Level PIR Motion Sensor	With 480V	480V With DC Bi-Level PIR Motion Sensor	With Emergency Battery Backup	Battery Backup With DC Bi-Level PIR Motion Sensor	480V with Emergency Battery Backup	480V with Emergency Battery Backup and With DC Bi-Level PIR Motion Sensor
1 (90W / 110W / 130W) 12,010-17,588 Lumens	4000K/5000K	36100	36106	36109	36110	36107	36108	36111	36112
2 (140W / 150W / 165W) 19,859-23,736 Lumens	4000K/5000K	36101	36113	36116	36117	36114	36115	36118	36119
3 (180W / 200W / 220W) 24,540-31,023 Lumens	4000K/5000K	36102	36120	36123	36124	36121	36122	36125	36126
4 (240W / 280W / 320W) 32,450-45,237 Lumens	4000K/5000K	36103	36127	36130	36131	36128	36129	36132	36133



Pendant Mount



Surface Mount

Mount Selector

Product SKU	Product Description
36151	Pendant Mount for CLHB-1, CLHB-2
36153	Pendant Mount for CLHB-3, CLHB-4
36152	Surface Mount for CLHB-1, CLHB-2
36154	Surface Mount for CLHB-3 CLHB-4

ProLED Select Compact Linear High Bay Series

Specifications Table

	CLHB-1-WS-CS-U	CLHB-2-WS-CS-U	CLHB-3-WS-CS-U	CLHB-4-WS-CS-U
Nominal Wattage	90W, 110W or 130W Selectable	140W, 150W or 165W Selectable	180W, 200W or 220W Selectable	240W, 280W or 320W Selectable
Delivered Lumens	12,010-17,588 Lumens	19,859-23,736 Lumens	24,540-31,023 Lumens	32,450-45,237 Lumens
Efficacy (lm/W)	134-137 LPW	141-143 LPW	140-143 LPW	140-143 LPW
CCT	4000K/ 5000K Selectable			
CRI	80+			
L70 Lifetime (hrs)	50,000			
Voltage	120-277VAC			
Power Factor	>0.9			
Dimming	0-10V			
Housing Material	Die-cast Aluminum with Powder Coated Finish			
Lens	Acrylic			
Operating Temperature	-40°-50° C			
BUG	B4 U3 G2	B4 U5 G1	B5 U5 G1	5 U5 G2
Listings	UL, cUL, DLC 5.1 Premium			
Environment	Environmental Rating IP20, UL Damp Location Rating			
Weight	5.73 lbs	6.83 lbs	9.26 lbs	10.14 lbs
Warranty	5 Years Standard			

Performance Table

Product Code	Selectable Wattage	4000K		5000K	
		Lumen(lm)	Efficacy(lm/W)	Lumen(lm)	Efficacy(lm/W)
CLHB-1-WS-CS-U	70W	9590	137	9870	141
	90W	12240	136	12600	140
	130W	17420	134	18330	141
CLHB-2-WS-CS-U	140W	20020	143	20160	144
	150W	21150	141	21450	143
	165W	23265	141	23595	143
CLHB-3-WS-CS-U	180W	25740	143	26100	145
	200W	28200	141	28800	144
	220W	30800	140	30580	139
CLHB-4-WS-CS-U	240W	34800	145	35040	146
	280W	39200	140	40040	143
	320W	44800	140	44480	139

ProLED Select Compact Linear High Bay Series

Dimensions

CLHB-1

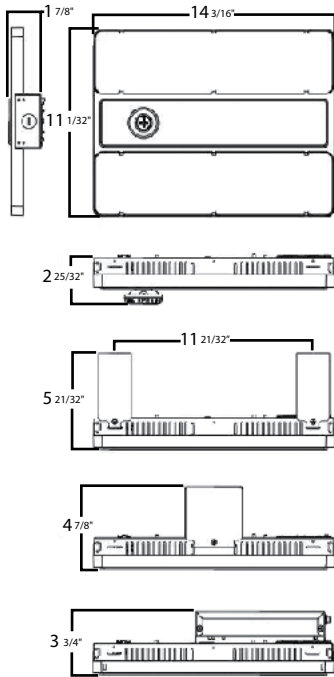

CLHB-2

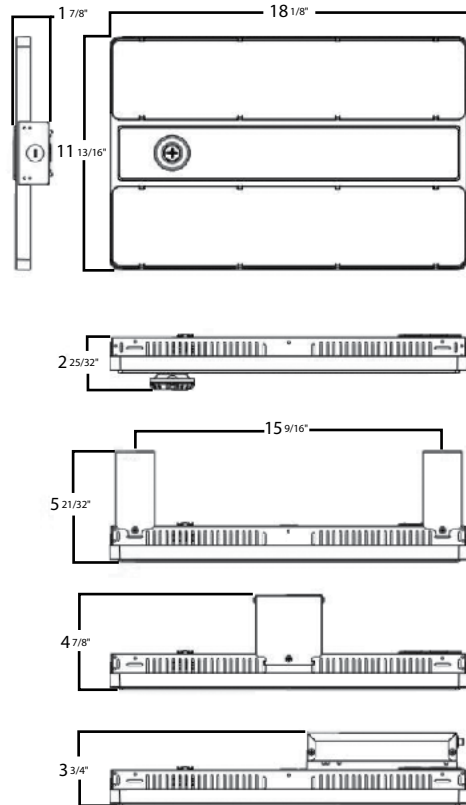

CLHB-3

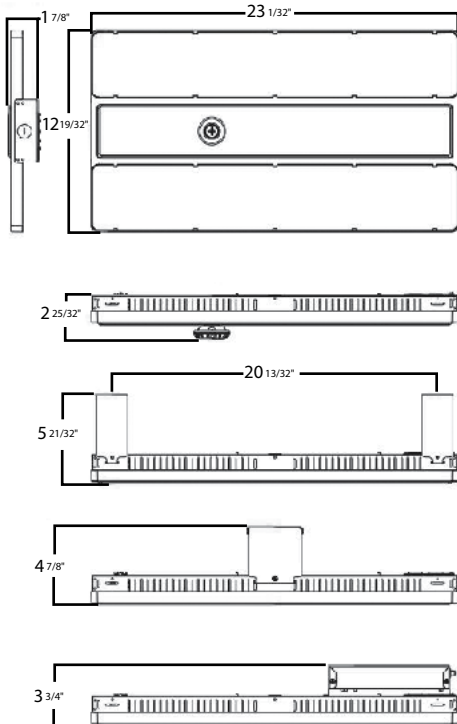

CLHB-4

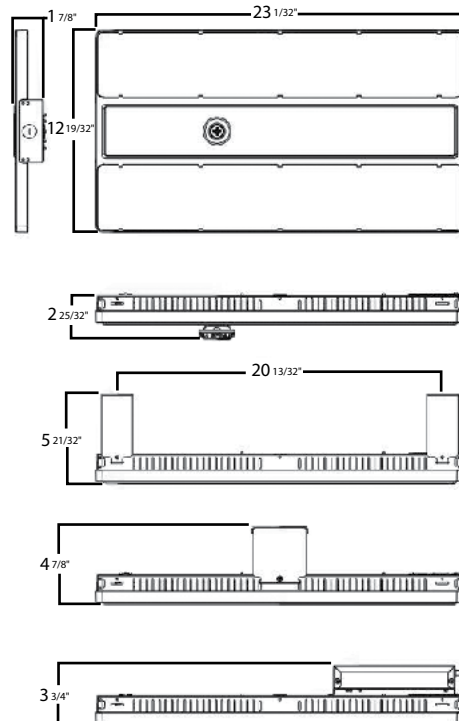

LED Luminaires

ProLED Select Compact Linear High Bay Series Photometrics

Luminous Intensity Distribution Curve

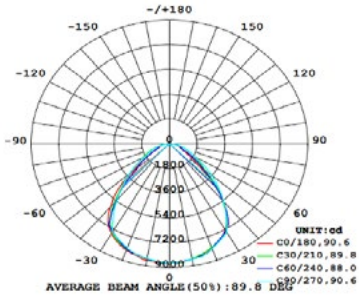

CLHB-1-WS-CS-U 5000K		
ZONE	LUMENS	% LAMP LUMENS
(0°-30°)	2917	19.6
(30°-60°)	3376	22.7
(60°-80°)	742	5
(80°-90°)	102	0.7
(0°-30°)	2968	19.9
(30°-60°)	3706	24.9
(60°-80°)	804	5.4
(80°-90°)	138	0.9
(90°-100°)	7	0
(100°-180°)	122	0.8

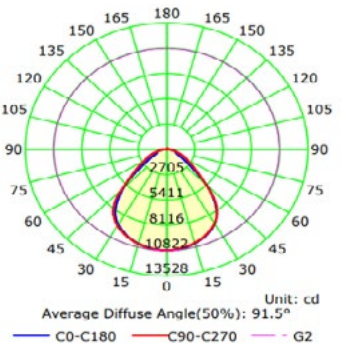

CLHB-2-WS-CS-U 5000K		
ZONE	LUMENS	% LAMP LUMENS
(0°-30°)	4208	17.7
(30°-60°)	5859	24.7
(60°-80°)	1247	5.3
(80°-90°)	166	0.7
(0°-30°)	4257	17.9
(30°-60°)	6260	26.4
(60°-80°)	1335	5.6
(80°-90°)	209	0.9
(90°-100°)	9	0
(100°-180°)	186	0.8

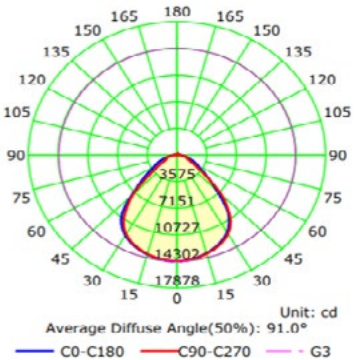

CLHB-3-WS-CS-U 5000K		
ZONE	LUMENS	% LAMP LUMENS
(0°-30°)	5588	18
(30°-60°)	7881	25.4
(60°-80°)	1678	5.4
(80°-90°)	241	0.8
(0°-30°)	5598	18
(30°-60°)	7883	25.4
(60°-80°)	1668	5.4
(80°-90°)	229	0.7
(90°-100°)	11	0
(100°-180°)	246	0.8

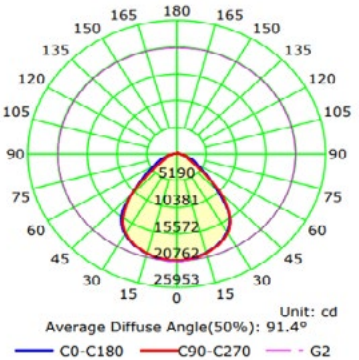

CLHB-4-WS-CS-U 5000K		
ZONE	LUMENS	% LAMP LUMENS
(0°-30°)	8107	17.9
(30°-60°)	11504	25.4
(60°-80°)	2410	5.3
(80°-90°)	325	0.7
(0°-30°)	8124	18
(30°-60°)	11626	25.7
(60°-80°)	2438	5.4
(80°-90°)	339	0.7
(90°-100°)	16	0
(100°-180°)	350	0.8

*For complete photometry/IES files, please contact the factory. For all IES files please visit halcolighting.com

ProLED Select Compact Linear High Bay Series

Controls

Motion Sensor / PIR Sensor:

Product SKU	Product Code	Product Description
99986	LHB/MC	(0-10V) Motion Control Sensor LSXR 610 HL - Side Knockout Install

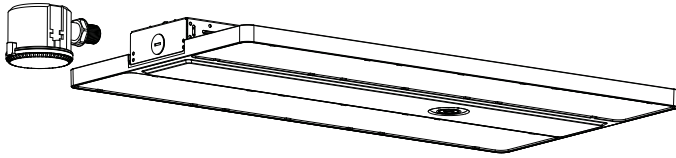

Wiring Instruction

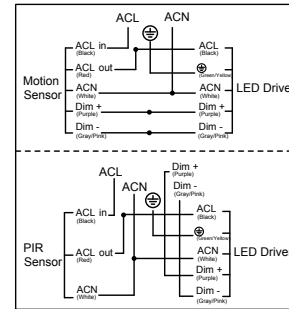

Motion Sensor / PIR Sensor:

Product SKU	Product Code	Product Description
24975	DCMSPIR	DC Bi-Level PIR (Passive Infrared) Motion Sensor, order minimum one remote (24876) per site
24875	DCMS	DC Bi-Level Motion Sensor, order minimum one remote (24876) per site
24876	DCMS-REM	DC Bi-Level Motion Sensor Remote

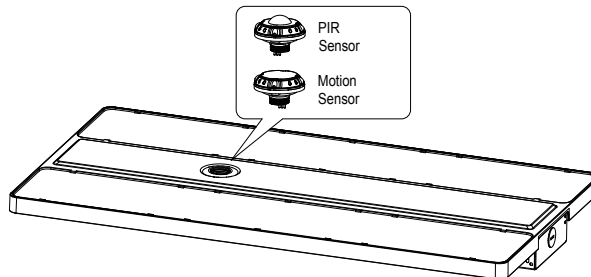

ProLED Select Compact Linear High Bay Series

Wire Guard for CLHB-1

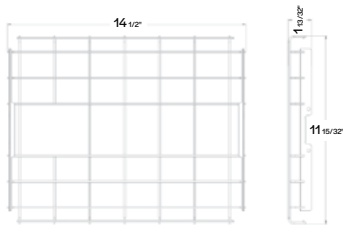

Pendant Mount for CLHB-1, CLHB-2

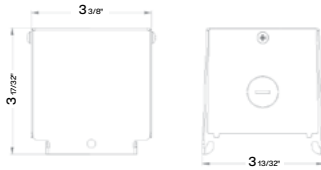

Surface Mount for CLHB-1, CLHB-2

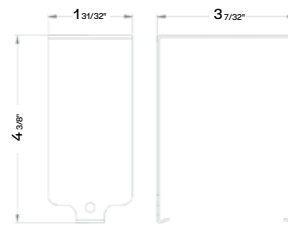

Wire Guard for CLHB-2

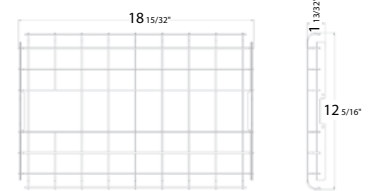

Pendant Mount for CLHB-3 CLHB-4



Surface Mount for CLHB-3 CLHB-4

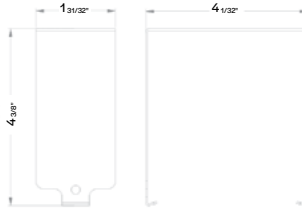

Wire Guard for CLHB-3, CLHB-4



Accessories Ordering Information

Accessories purchased separately

Product SKU	Product Code	Product Description
36148	CLHB-1-A-WG	Wire Guard for CLHB-1
36149	CLHB-2-A-WG	Wire Guard for CLHB-2
36150	CLHB-34-A-WG	Wire Guard for CLHB-3, CLHB-4
36151	CLHB-12-M-PEND	Pendant Mount for CLHB-1, CLHB-2
36152	CLHB-12-M-SURF	Surface Mount for CLHB-1, CLHB-2
36153	CLHB-34-M-PEND	Pendant Mount for CLHB-3 CLHB-4
36154	CLHB-34-M-SURF	Surface Mount for CLHB-3 CLHB-4
36155	CLHB-BBU-9	Battery Backup (9W/90Min) for CLHB
36156	CLHB-12-DR-480V	Driver (150W) 277-480VAC for CLHB-1 CLHB-2
36157	CLHB-3-DR-480V	Driver (200W) 277-480VAC for CLHB-3
36158	CLHB-4-DR-480V	Driver (320W) 277-480VAC for CLHB-4

*When using CLHB-BBU-9 or 16 and DCMS Motion Sensor, DCMS sensor must be set to ∞ standby time on the motion sensor remote. This setting allows fixture to not turn off in EM mode.