

## Features

- High Efficiency (Up to 91%)
- Active Power Factor Correction (0.99 Typical)
- Constant Current Output
- 0-10V Dimming Control
- Input Surge Protection: DM 4kV, CM 6kV
- All-Around Protection: OVP, SCP, OTP
- IP67 and Damp & Wet Location
- TYPE HL, for use in a Class I, Division 2 hazardous (Classified) location



## Description

The EUC-085SxxxDT(ST) series is a 85W, constant-current LED driver that operates from 90-305 Vac input with excellent power factor. It is created for many lighting applications including low bay, tunnel and street, etc. The high efficiency of these drivers and compact metal case enables them to run cooler, significantly improving reliability and extending product life. To ensure trouble-free operation, protection is provided against input surge, output over voltage, short circuit, and over temperature.

## Models

Output Current	Input Voltage Range(1)	Output Voltage Range	Max. Output Power	Typical Efficiency (2)	Power Factor		Model Number (3,4)
					120Vac	220Vac	
350 mA	90 ~ 305 Vac	121~243Vdc	85 W	91%	0.99	0.95	EUC-085S035DT(ST) <sup>(5)</sup>
450 mA	90 ~ 305 Vac	94~189 Vdc	85 W	91%	0.99	0.95	EUC-085S045DT(ST) <sup>(5)</sup>
700 mA	90 ~ 305 Vac	61~121 Vdc	85 W	90%	0.99	0.95	EUC-085S070DT(ST) <sup>(5)</sup>
1050 mA	90 ~ 305 Vac	40~81 Vdc	85 W	90%	0.99	0.95	EUC-085S105DT(ST) <sup>(5)</sup>
1400 mA	90 ~ 305 Vac	30~61 Vdc	85 W	90%	0.99	0.95	EUC-085S140DT(ST) <sup>(5)</sup>
1750 mA	90 ~ 305 Vac	24~49 Vdc	85 W	90%	0.99	0.95	EUC-085S175DT(ST) <sup>(6)</sup>
2000 mA	90 ~ 305 Vac	21~43 Vdc	85 W	90%	0.99	0.95	EUC-085S200DT(ST) <sup>(6)</sup>
2450 mA	90 ~ 305 Vac	17~35 Vdc	85 W	89%	0.99	0.95	EUC-085S245DT(ST) <sup>(7)</sup>
2800 mA	90 ~ 305 Vac	15~30 Vdc	85 W	89%	0.99	0.95	EUC-085S280DT(ST) <sup>(7)</sup>

**Notes:** (1) Certified input voltage range: UL, FCC 100-277Vac; otherwise 100-240Vac.

(2) Measured at 100% load and 220 Vac input.

(3) The DT suffix may be changed to ST to omit the dimming function and remove the two wires associated with that function.

(4) All the models are certificated to KS, except EUC-085S035DT(ST).

(5) Non-Class2 output (USR & CNR).

(6) Class 2 output (USR only) for Dry and Damp Location.

(7) Class 2 output (USR & CNR) for Dry and Damp Location; Class 2 output (CNR only) for Wet Location.

## Input Specifications

Parameter	Min.	Typ.	Max.	Notes
Input Voltage	90 Vac	-	305 Vac	
Input Frequency	47 Hz	-	63 Hz	
Leakage Current	-	-	0.75 mA	At 277Vac 60Hz input
Input AC Current	-	-	1.1 A	Measured at 100% load and 100 Vac input.
	-	-	0.5 A	Measured at 100% load and 220 Vac input.
Inrush Current	-	-	60 A	At 220Vac input, 25°C cold start, duration=1 ms, 10%lpk-10%lpk.
Inrush Current(I <sup>2</sup> t)	-	-	1 A <sup>2</sup> s	
Power Factor	0.90	-	-	At 100Vac-277Vac, 50-60Hz,100% Load
THD	-	-	20%	

## Output Specifications

Parameter	Min.	Typ.	Max.	Notes
Output Current Range	-5%	-	5%	
Ripple and Noise (pk-pk)	-	-	3% V <sub>O</sub>	Measured by 20 MHz bandwidth oscilloscope and the output paralleled a 0.1 uF ceramic capacitor and a 10 uF electrolytic capacitor.
Output Current Ripple at < 200 Hz (pk-pk)	-	1%I <sub>o</sub>	-	At 100% load condition. Only this component of ripple is associated with visible flicker.
Output Overshoot / Undershoot	-	-	10%	When power on or off.
No-load Output Voltage				
I <sub>o</sub> = 350 mA	-	-	255V	
I <sub>o</sub> = 450 mA	-	-	198V	
I <sub>o</sub> = 700 mA	-	-	129V	
I <sub>o</sub> = 1050 mA	-	-	87V	
I <sub>o</sub> = 1400 mA	-	-	67V	
I <sub>o</sub> = 1750 mA	-	-	54V	
I <sub>o</sub> = 2000 mA	-	-	48V	
I <sub>o</sub> = 2450 mA	-	-	39V	
I <sub>o</sub> = 2800 mA	-	-	33V	
Line Regulation	-	-	±2%	
Load Regulation	-	-	±3%	
Turn-on Delay Time	-	2.0 s	3.0 s	Measured at 120Vac input.
	-	0.6 s	1.0 s	Measured at 220Vac input.
Temperature Coefficient	-	-	0.06%/°C	Case temperature = 0°C ~T <sub>c</sub> max

## Protection Functions

Parameter	Min.	Typ.	Max.	Notes
Over Temperature Protection-Tc	-	100 °C	-	Latch mode. The power supply shall return to normal operation only after the power is turn-on again.
Short Circuit Protection	No damage shall occur when any output operating in a short circuit condition. The power supply shall be self-recovery when the fault condition is removed.			

## General Specifications

Parameter	Min.	Typ.	Max.	Notes
Efficiency $I_o = 350 \text{ mA}$ $I_o = 450 \text{ mA}$ $I_o = 700 \text{ mA}$ $I_o = 1050 \text{ mA}$ $I_o = 1400 \text{ mA}$ $I_o = 1750 \text{ mA}$ $I_o = 2000 \text{ mA}$ $I_o = 2450 \text{ mA}$ $I_o = 2800 \text{ mA}$	88% 88% 87% 87% 87% 87% 86% 86%	89% 89% 88% 88% 88% 88% 87% 87%	- - - - - - - -	Measured at 100% load, 120Vac input, 25°C ambient temperature, after the unit is thermally stabilized. It will be lower about 2%, if measured immediately after startup.
Efficiency $I_o = 350 \text{ mA}$ $I_o = 450 \text{ mA}$ $I_o = 700 \text{ mA}$ $I_o = 1050 \text{ mA}$ $I_o = 1400 \text{ mA}$ $I_o = 1750 \text{ mA}$ $I_o = 2000 \text{ mA}$ $I_o = 2450 \text{ mA}$ $I_o = 2800 \text{ mA}$	90% 90% 89% 89% 89% 89% 88% 88%	91% 91% 90% 90% 90% 90% 89% 89%	- - - - - - - -	Measured at 100% load, 220Vac input, 25°C ambient temperature, after the unit is thermally stabilized. It will be lower about 2%, if measured immediately after startup.
MTBF	-	237,000 hours	-	Measured at 120Vac input, 80%Load and 25°C ambient temperature (MIL-HDBK-217F)
Lifetime	-	101,000 hours	-	Measured at 120Vac input, 80%Load ; Case temperature=60°C @ Tc point. See life time vs. Tc curve for the details
Operating Case Temperature for Safety Tc_s	-40 °C	-	+90°C	
Operating Case Temperature for Warranty Tc_w	-40 °C	-	+70 °C	
Storage Temperature	-40 °C	-	+85 °C	Humidity: 5% RH to 100% RH
Dimensions Inches (L x W x H) Millimeters (L x W x H)	5.91 x 2.66 x 1.44 150 x 67.5 x 36.5			With mounting ear 6.97 x 2.66 x 1.44 177 x 67.5 x 36.5
Net Weight	-	780 g	-	

## Safety & EMC Compliance

Safety Category	Standard
UL/CUL	UL8750, UL 1310, CAN/CSA-C22.2 No. 250.13, CAN/CSA-C22.2 No. 223-M91
CE	EN 61347-1, EN 61347-2-13
KS	KS C 7655

## Safety & EMC Compliance(Continued)

EMI Standards	Notes
EN 55015 <sup>(1)</sup>	Conducted emission Test & Radiated emission Test
EN 61000-3-2	Harmonic current emissions
EN 61000-3-3	Voltage fluctuations & flicker
FCC Part 15 <sup>(1)</sup>	ANSI C63.4 Class B
	This device complies with Part 15 of the FCC Rules. Operation is subject to the following two conditions: [1] this device may not cause harmful interference, and [2] this device must accept any interference received, including interference that may cause undesired Operation.
EMS Standards	Notes
EN 61000-4-2	Electrostatic Discharge (ESD): 8 kV air discharge, 4 kV contact discharge
EN 61000-4-3	Radio-Frequency Electromagnetic Field Susceptibility Test-RS
EN 61000-4-4	Electrical Fast Transient / Burst-EFT
EN 61000-4-5	Surge Immunity Test: AC Power Line: Differential Mode 4 kV, Common Mode 6 kV
EN 61000-4-6	Conducted Radio Frequency Disturbances Test-CS
EN 61000-4-8	Power Frequency Magnetic Field Test
EN 61000-4-11	Voltage Dips
EN 61547	Electromagnetic Immunity Requirements Applies to Lighting Equipment

**Note:** (1) This LED driver meets the EMI specifications above, but EMI performance of a luminaire that contains it depends also on the other devices connected to the driver and on the fixture itself.

## Lifetime vs. Case Temperature Curve

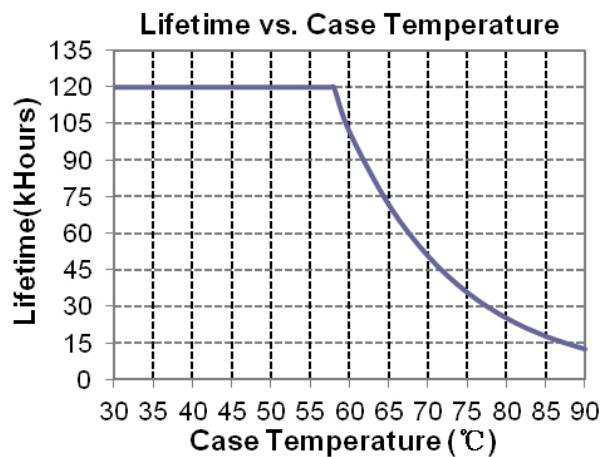

## Efficiency vs. Load

EUC-085S035DT(ST)

Efficiency vs. Output Voltage

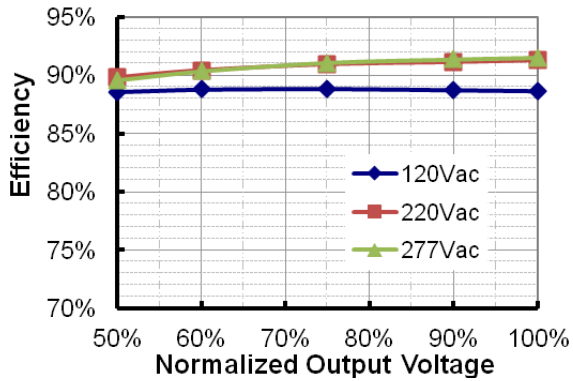

EUC-085S045DT(ST)

Efficiency vs. Output Voltage

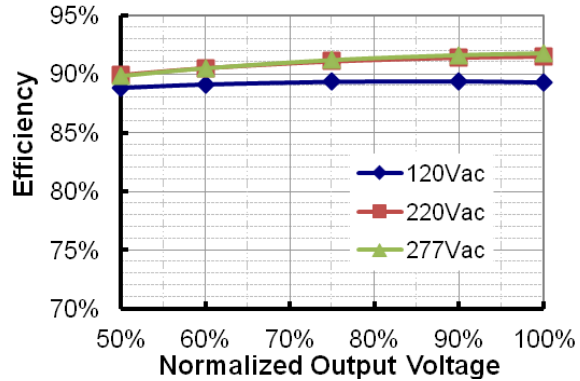

EUC-085S070DT(ST)

Efficiency vs. Output Voltage

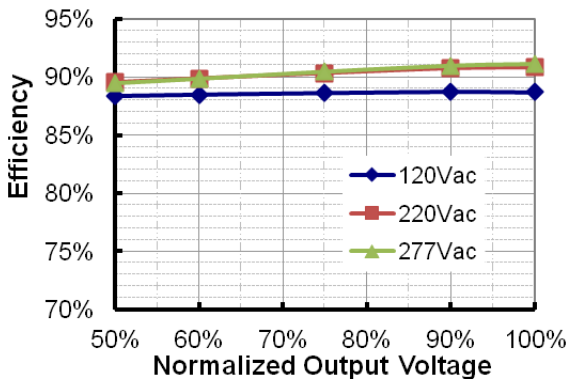

EUC-085S105DT(ST)

Efficiency vs. Output Voltage

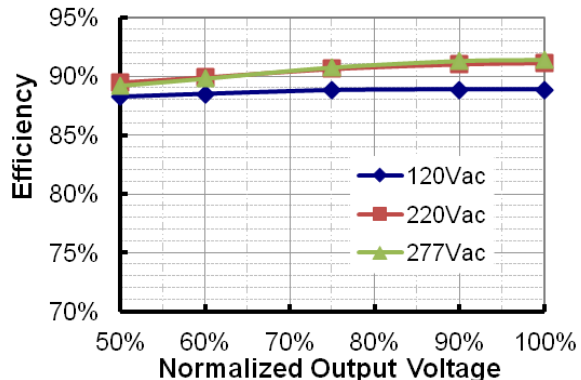

EUC-085S140DT(ST)

Efficiency vs. Output Voltage

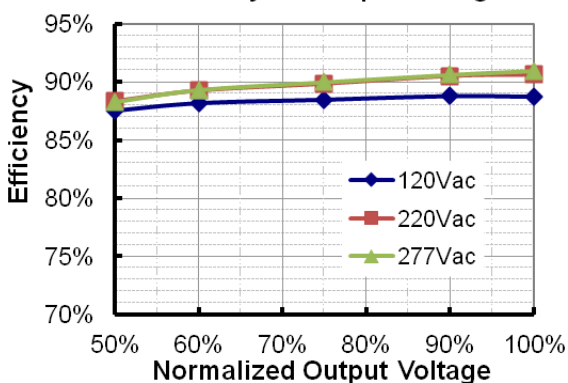

EUC-085S175DT(ST)

Efficiency vs. Output Voltage

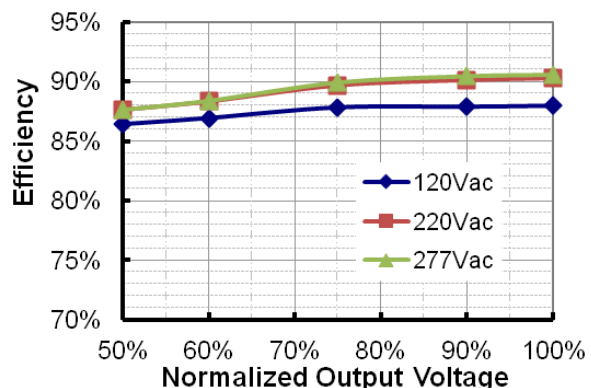

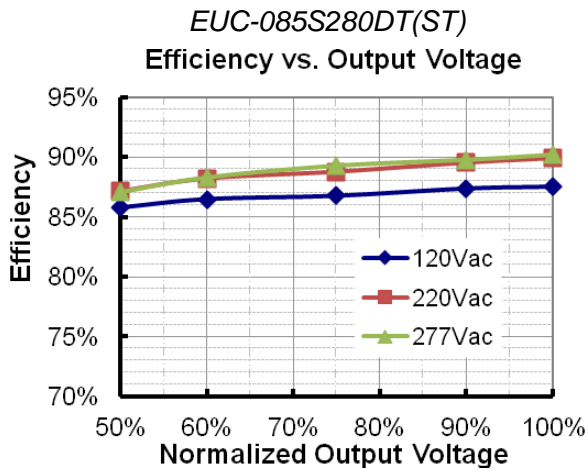
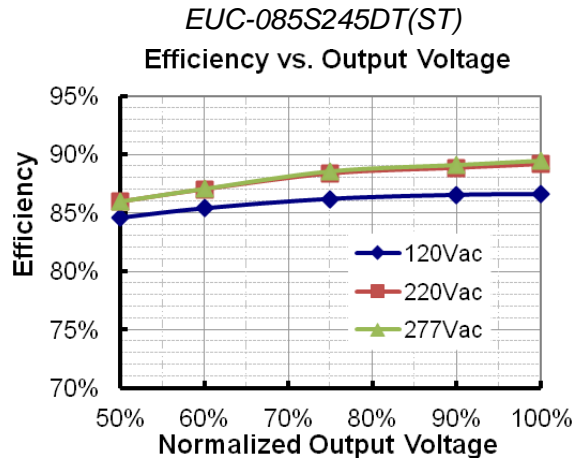
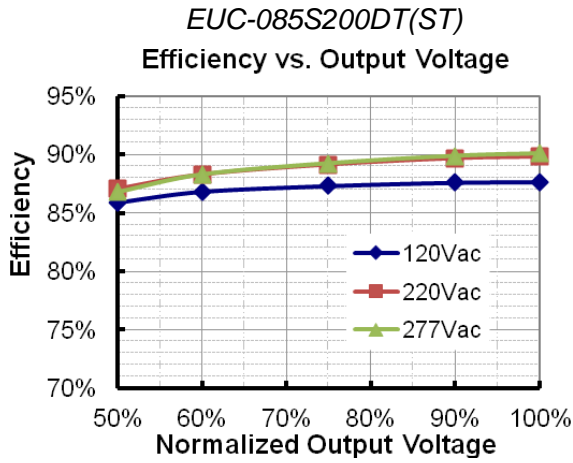

## Dimming Control

Parameter	Min.	Typ.	Max.	Notes
Absolute maximum voltage on 1-10V input pin	-2 V	-	12 V	
Source current on 1~10V input pin	0 mA	-	0.5 mA	

The dimmer control may be operated from either a potentiometer or from an input signal of 1 – 10 Vdc. Two recommended implementations are provided below.

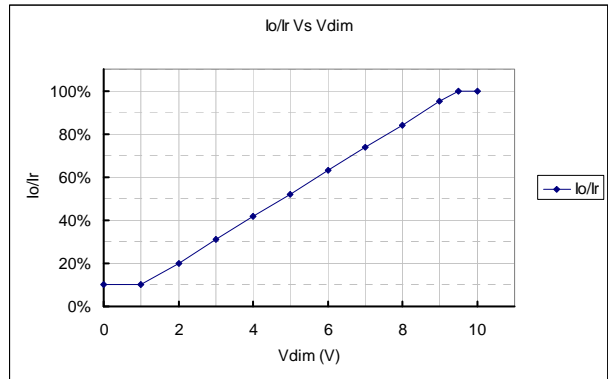
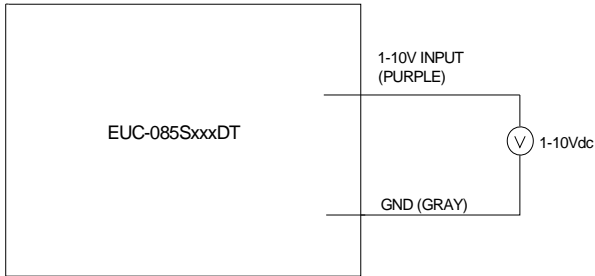

Implementation 1: DC input

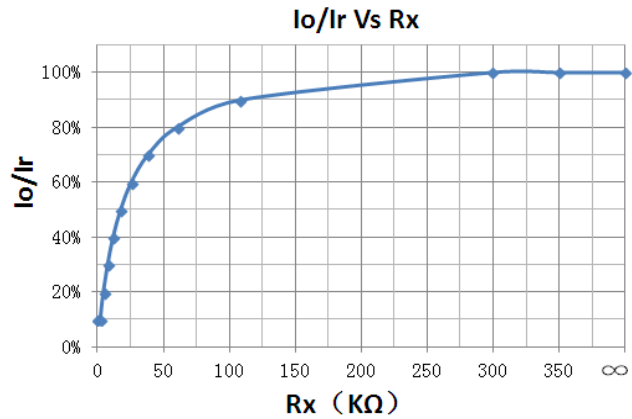
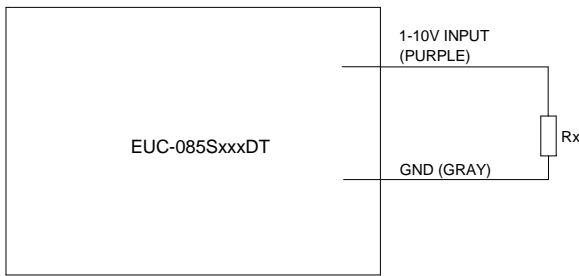

Implementation 2: External resistor

**Notes:**

1. Io is actual output current and Ir is rated current without dimming control.
2. For the driver to operate properly, the load voltage must be maintained above the minimum voltage threshold (approx. 50% of the max. output voltage for any given model).
3. If the output voltage is maintained above 50% of the maximum output voltage, the dimming control may be operated over the entire 1-10V range with output current varying from 100% down to practically 10%.
4. The dimming signal is allowed to be less than 1V, however, when it for 0-1V, the output current is 10%Io.
5. Do not connect the GND of dimming to the output; otherwise, the LED driver can not work normally.

## Mechanical Outline

### EUC-085SxxxDT

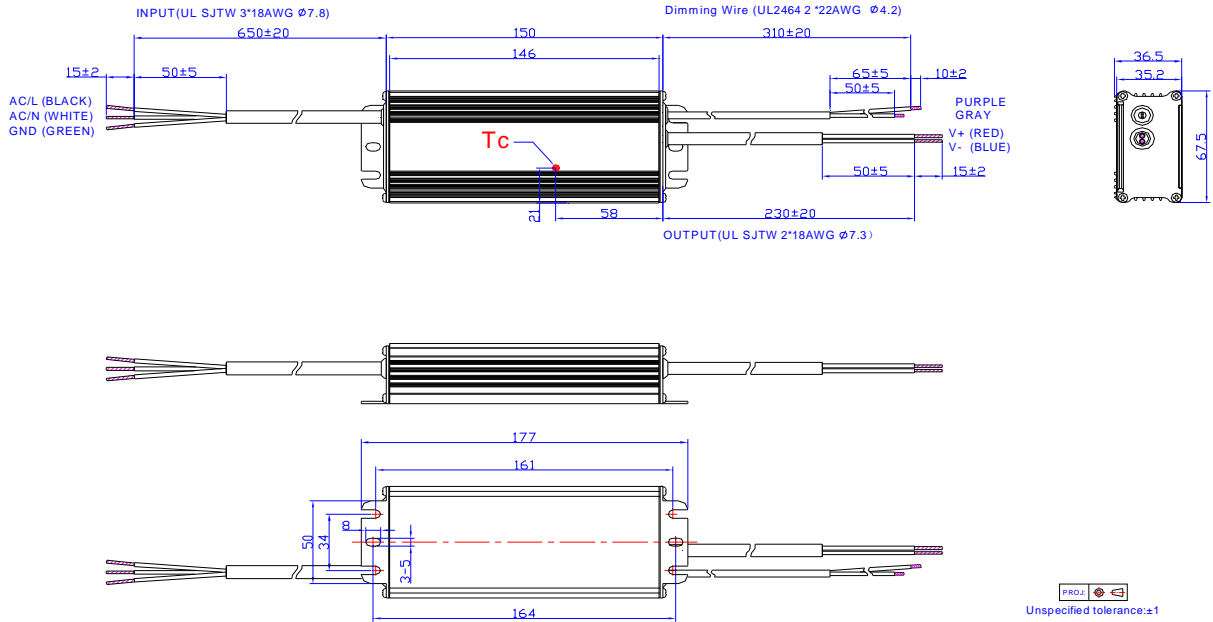

### EUC-085SxxxST

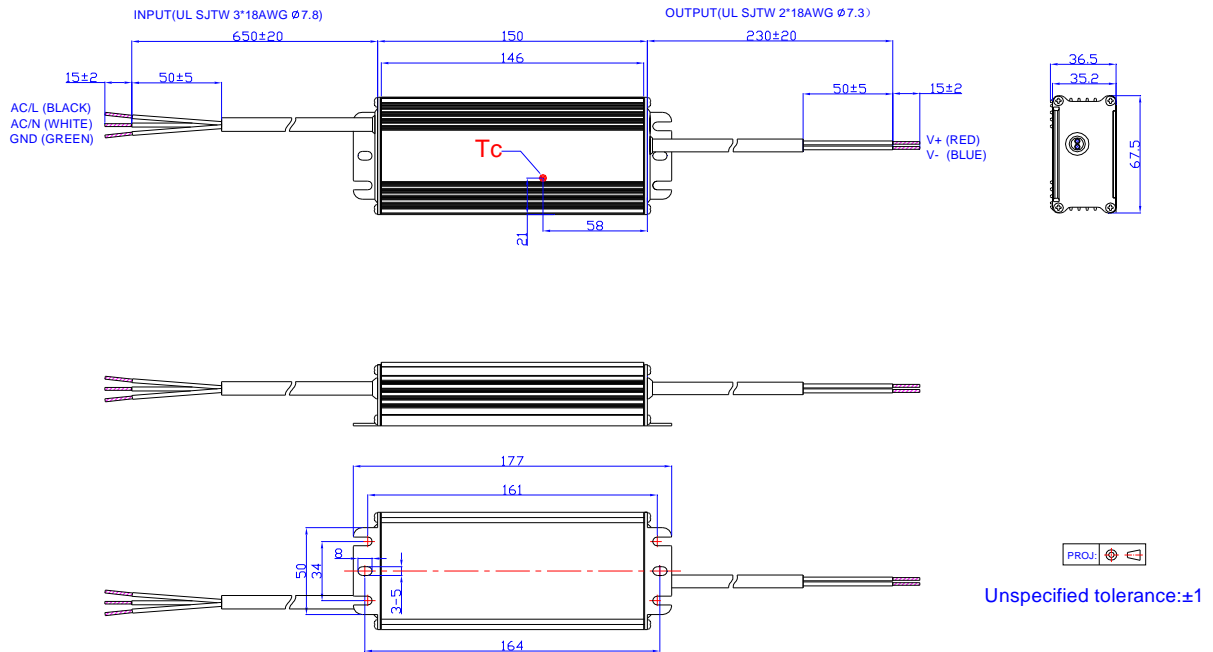

## RoHS Compliance

Our products comply with reference to RoHS Directive (EU) 2015/863 amending 2011/65/EU, calling for the elimination of lead and other hazardous substances from electronic products.



## Revision History

Change Date	Rev.	Description of Change		
		Item	From	To
2010-09-01	A	Add EUC-085SxxxST Series	EUC-085SxxxDT	EUC-085SxxxST/DT
		Add notes of UL1310 Class 2 for all models.	/	(4) (5) (6)
		Add No-load Output Voltage	/	The typ. value of every model.
		Change Ripple and Noise (pk-pk)	5% VO	1% VO
		Change Line Regulation	1%	2%
		Change efficiency for all models	/	/
		Change MTBF	498,000 hours	300,000 hours
		Change Life Time	90,000 hours	63,000 hours
		Change Net Weight	750 g	770 g
		Delete the Dimming Implementation-- External zener diodes	Implementation 2: External zener diodes	/
		Change Mechanical Outline The dimming control Wire The output Wire	Purple / Green Red / Black	Purple / Gray Red / Blue
2010-9-29	B	Change Output Voltage Range Io= 350 mA Io= 450 mA Io= 700 mA Io= 1050 mA Io= 1400 mA Io= 1750 mA Io= 2000 mA Io= 2450 mA Io= 2800 mA	Min. 121V 94 V 61 V 40 V 30 V 24 V 21 V 17 V 15 V	Min. 122V 95 V 61 V 41 V 31 V 25 V 22 V 18 V 16 V
		Change Ripple and Noise (pk-pk)	Max. 1% Vo	Max. 3% Vo
2010-11-17	C	Add Derating Curve	/	/
2012-02-23	D	Mechanical Outline	the position of the wire outing hole	Changed
		OTP	120°C	110°C
2012-06-19	E	Life time curve	/	Added
		EN61000-4-5	line to line 2 kV, line to earth 4 kV	line to line 4 kV, line to earth 6 kV
		Max of No-load Output Voltage	/	Added
2012-7-5	F	Inrush Current	50 A	60 A
2012-7-17	G	Max Case Temperature	/	Updated
2012-9-27	H	Min PF, Max THD	/	Added
		Temperature coefficient	/	Added
		MTBF, Life time Typical Value	/	Added

## Revision History (Continued)

Change Date	Rev.	Description of Change		
		Item	From	To
2012-9-27	H	Life Time Curve	/	Updated
		Operating Temperature	-35°C	-40°C
		Derating Curve	/	Updated
2013-06-06	I	Product photo	/	Updated
		Min Output Voltage	/	Corrected
		Leakage current	1 mA	0.75 mA
		Typical value of OTP	110°C	100°C
		MTBF	320,000 hours	237,000 hours
		Derating Curve	/	Updated
		Efficiency curve	/	Added
2016-04-20	J	Mechanical outline	/	Updated
		KS	/	Added
		Features	/	Updated
		Description	/	Updated
		Models	/	Updated
		Output Specifications	Output Current Ripple at < 200 Hz (pk-pk)	Added
		General Specifications	Case Temperature	Operating Case Temperature for Safety Tc_s
		General Specifications	Operating Case Temperature for Warranty Tc_w	Added
		General Specifications	Storage Temperature	Added
		General Specifications	With mounting ear	Added
		General Specifications	Net Weight	Updated
		Environmental Specifications	/	Delete
		Safety & EMC Compliance	/	Updated
Mechanical outline	/	Updated		
2019-08-22	K	Features	Input surge protection	Updated
		Description	/	Updated
		Input Specifications(PF/THD)	50-60Hz	Added
		Safety & EMC Compliance	UL/CUL	Updated

## Revision History (Continued)

Change Date	Rev.	Description of Change		
		Item	From	To
2019-08-22	K	Safety &EMC Compliance	KS	Updated
		Safety &EMC Compliance	FCC	Updated
		Safety &EMC Compliance	EN 61000-4-5	Updated
		Mechanical Outline	/	Updated
		RoHS Compliance	/	Updated
2020-01-13	L	Features	Waterproof(IP67)	IP67
		Models	Notes(1)	Added
		Derating Curve	/	Deleted
		Format	Page footer	Updated