

KT-EM-TP1-XXWL-SU

EXIT SIGN

INSTALLATION INSTRUCTIONS

PLEASE FIND A QUALIFIED ELECTRICIAN FOR INSTALLATION. Please read the instructions before you install and use the fixture.

SAFETY AND ELECTRICAL PARAMETERS

WARNING:

- FAILURE TO FOLLOW THESE INSTRUCTIONS AND WARNINGS MAY RESULT IN DEATH, SERIOUS INJURY OR SIGNIFICANT PROPERTY DAMAGE. FOR YOUR PROTECTION, READ AND FOLLOW THESE WARNINGS AND INSTRUCTIONS CAREFULLY BEFORE INSTALLING OR MAINTAINING THIS EQUIPMENT. THESE INSTRUCTIONS DO NOT ATTEMPT TO COVER ALL INSTALLATION AND MAINTENANCE SITUATIONS. IF YOU DO NOT UNDERSTAND THESE INSTRUCTIONS OR ADDITIONAL INFORMATION IS REQUIRED, CONTACT THE MANUFACTURER.
- RISK OF ELECTRICAL SHOCK – NEVER CONNECT TO, DISCONNECT FROM, OR SERVICE WHILE EQUIPMENT IS ENERGIZED.
- RISK OF FIRE: Lamps are hot. Keep combustible material away from hot parts. Observe lamp manufacture's warnings, recommendations and restrictions on lamp operation and maintenance. Make sure lamps are correctly installed.

CAUTION:

- The battery in this unit may not be fully charged. After electricity is connected to unit, let battery charge for at least 24 hours, then normal operation of this unit should take effect.

IMPORTANT SAFEGUARDS:

When using electrical equipment, basic safety precautions should always be followed, including:

- Do not use outdoors.
- Equipment should be mounted in locations and at heights where it will not be subject to tampering by unauthorized personnel.
- Do not mount near gas or electric heaters.
- The use of accessory equipment not recommended by the manufacturer may cause an unsafe condition.
- Do not use this equipment for anything other than its intended use.
- Service of this equipment should be performed by qualified personnel.
- Disconnect AC power before servicing.

IMPORTANT CODE COMPLIANCE INFORMATION:

In accordance with NFPA 101 (current Life Safety Code), documented testing of your emergency lighting system must be tested monthly for a minimum of 30 seconds and annually for 90 minutes. Refer to your local codes for any additional requirements that may apply.

WIRING DIAGRAMS

GENERAL WIRING DIAGRAM

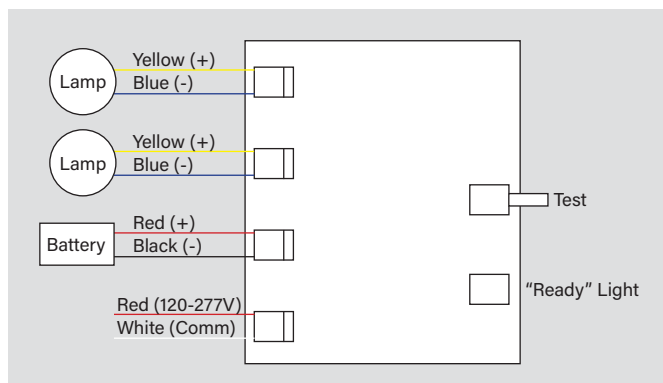

COMPONENTS INCLUDED IN KIT

Part
1x Lighting Fixture
1x Rechargeable Battery
1x Mounting Hardware & Connection Accessory Kit

Caution: Before installing, ensure that AC power to the fixture is off.
Caution: The electrical rating of this product is 120–277V. Installer must confirm that there is 120–277V at the fixture before installation.

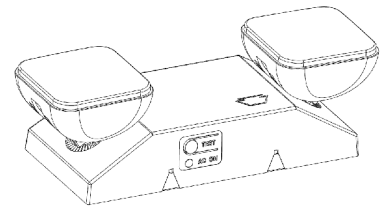

INSTALLATION INSTRUCTIONS

INSTALLATION (JUNCTION BOX MOUNTING)

1. Remove back panel by pressing two snaps at bottom of fixture (Fig. A). Drill or knockout appropriate knockouts on back panel for mounting and wiring.
2. Feed fixture leads through back plate and make wiring connections (Fig. A). Push connections into junction box.
3. Attach back panel to junction box and secure with screws.
4. Connect Battery (Fig. B)
5. Align snaps and push housing directly onto the back panel (Fig. C). Apply continuous AC power and press "TEST" button to check light.

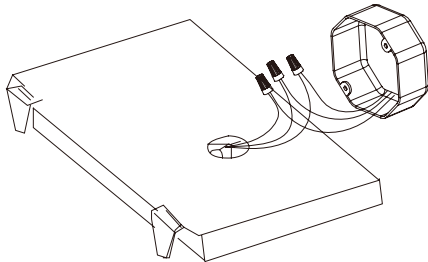

FIG. A (J-BOX)

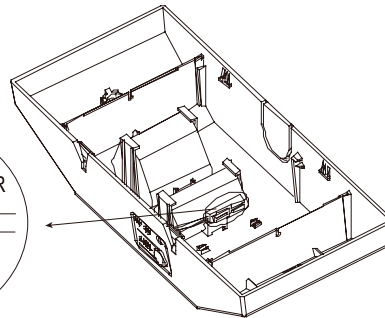
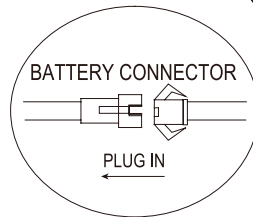

FIG. B

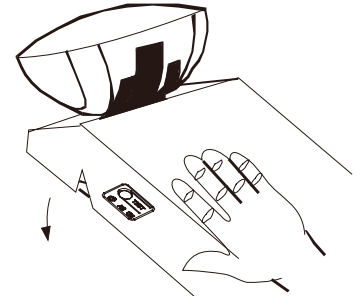
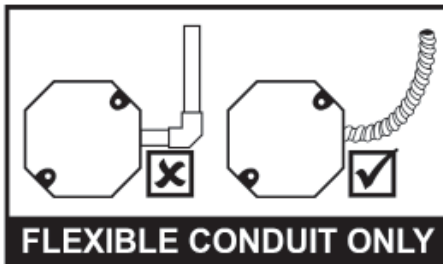

FIG. C

INSTALLATION (CONDUIT)

1. Secure back plate to wall surface. Route wires through hole in conduit flange and make conduit connection.
2. Connect Battery (Fig. B).
3. Align snaps and push housing directly onto the back plate (Fig. C). Apply continuous AC power and press "TEST" button to check light.



WARNING: Unused wires must be capped using enclosed wire nuts.

OPERATION (BATTERY BACKUP)

1. Apply AC power to the unit. The LED indicator will be RED.
2. After the battery has been left to charge for 24 hours, test the unit by pushing the switch. The LED Indicator turns OFF and the sign will remain illuminated.
3. When the switch is released, the LED indicator turns back to RED and the sign will remain illuminated.

MAINTENANCE

CAUTION: Always turn off AC power to the equipment before servicing. Servicing should be performed only by a qualified service technician. Use only MANUFACTURER supplied replacement parts.

BATTERY: The battery supplied requires no maintenance. However, it should be tested periodically and replaced when it no longer operates the connected sign for the duration of a 30 second or 90 minute test. The battery supplied in this sign has a typical life of 5 years when used in a normal ambient temperature of 72°F.