

2" PUSH AND LOCK REGRESSED TRIMLESS SPOTLIGHT - 5CCT SELECT LR25445, LR25446

IMPORTANT:
READ ALL INSTRUCTIONS BEFORE INSTALLING FIXTURES. KEEP FOR FUTURE REFERENCE.

SAFETY: FOR YOUR SAFETY, THIS FIXTURE MUST BE WIRED IN ACCORDANCE TO LOCAL ELECTRICAL CODES AND ORDINANCES. ALL WORK SHOULD BE DONE BY A QUALIFIED ELECTRICIAN.

WARNING: MAKE SURE POWER IS OFF FROM THE ELECTRICAL PANEL BEFORE STARTING INSTALLATION OR ATTEMPTING ANY MAINTENANCE. INDOOR INSTALLATION ONLY.

DO NOT CO-MINGLE DIFFERENT SIZES AND STYLES OF DIM RO WARM FIXTURES ON THE SAME DIMMER, NOT ALL FIXTURES WILL EXHIBIT THE SAME CORRELATED COLOR TEMPERATURES AT THE SAME DIMMING LEVEL.

TOOLS REQUIRED: SAW, MEASURING TAPE, ELECTRICAL WIRING (USE TAPE AND GAUGE SUITABLE FOR APPLICATION TO CONNECT THE FIXTURES).

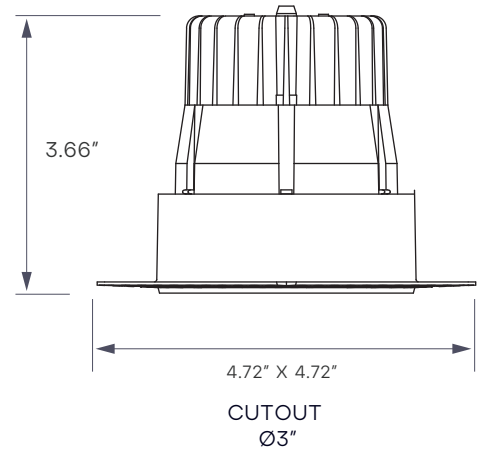

INSTRUCTIONS

