

MICROWAVE BI-LEVEL 1P SENSOR & RECEPTACLE

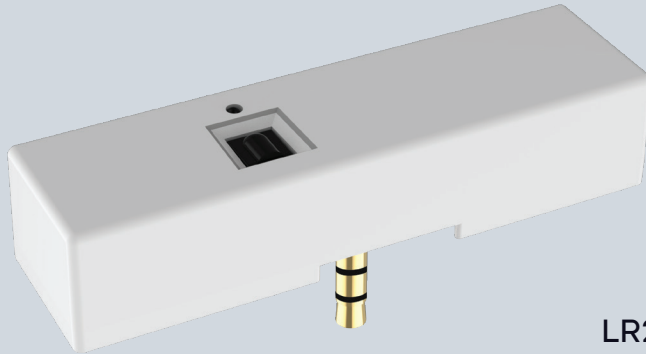

LR25372
AUDIO JACK
STANDARD SENSOR



LR25373
RECEPTACLE



12V

DIMMABLE

0-10V

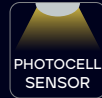

GENERAL

MODEL	DESCRIPTION	POWER	INPUT VOLTS	DIMMING	INSTALL HEIGHT	DETECTION RANGE	DETECTION ANGLE
LR25372	LEDSNS/LINEAR/MW/BiLevel/1P	<0.3W	12V	0-10V	13.12FT	9FT	30-150°
LR25373	LEDSNS/LINEAR/MW/BiLevel/1P/RECP						

DIMENSIONS

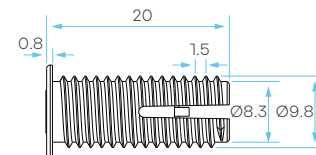
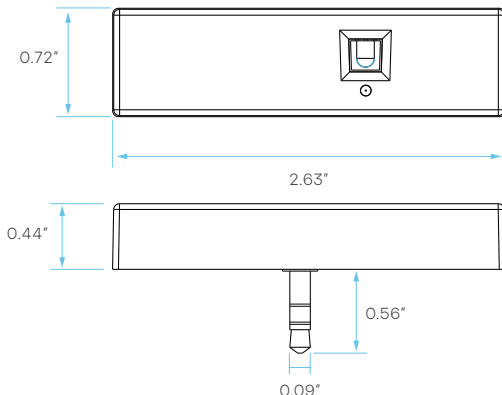

RECEPTACLE

PARAMETERS

MICROWAVE INFORMATION	Frequency	5.8GHz±75MHz
	Microwave Power	<0.3mW
	Installation Height	4m/13.12ft Max.
	Detection Distance	≥3m/9ft
	Detection Angle	30-150° (Without Glass Cover)
SENSOR PARAMETER	Detection Area	25%/50%/75%/100%
	Holdtime	Remote control Options : 5s/ 30s/ 1min/ 3min/ 5min/ 10min/ 20min/ 30min
	Daylight Threshold	Disable/400Lux/350Lux/300Lux/250Lux/200Lux/120Lux/ 80Lux/50Lux/30Lux/10Lux/2Lux
	Standby Dimming Level	10%/20%/30%/50%
	Standby Period	Remote control Options : 0s/ 10s/ 30s/ 1min/ 5min/ 10min/ 30min/ 60min/+∞ APP Control Options : 0s/5s/30s/1min/2min/3min/5min/10min/15min/20min/ 25min/30min/45min/60min/+∞
	Dusk/Dawn Sensing/ Photocell	Daylight threshold as 30lux/ 50lux/ 80lux/ 120lux/ 200Lux/ 250Lux/300Lux/ 350Lux/ 400Lux Standby period as +∞ ; Standby dimming level as 10%/20%/30%
Daylight Harvesting	1. Adjust "daylight" value higher than 50lux 2. Preset "standby period" 0S 3. press MW/PIR button 3 times till MW/PIR icons both blinking on LCD screen, daylight harvesting function enabled.	
INPUT	Input Range	12VDC
	Voltage Range	10-15VDC
	Current	Remote control Options : <30mA APP Control Options : <40mA
OUTPUT	Signal	DIM 0-10V
	Connection	TipDIM+, RingVCC, SleeveGND
	Stand-by Power	<0.5W
ENVIRONMENT	Working Temp	-25°C~+60°C
	Storage Temp	-40°C~+80°C Humidity: 85% (non-condensation)
CERTIFICATE & STANDARDS	Environmental Requirements	In accordance with CE ROHS
	IP Rating	IP20

WIRING DIAGRAM

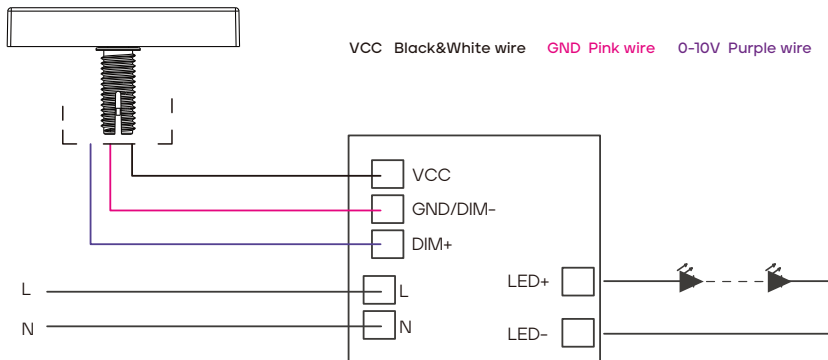

DETECTION COVERAGE

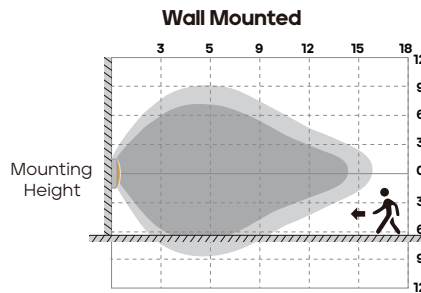
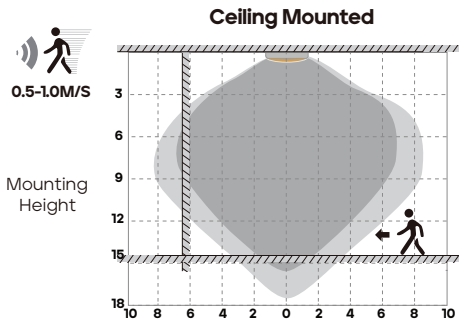

Highest mounting height is 13.2^{FT} (4m)

This figure indicates the maximum distance at the highest mounting height with 100% sensitivity.

Well Detected Area Possibly Detected Area

PERFORMANCE

1. DAYLIGHT HARVESTING

1. Adjust "daylight" value higher than 50lux
2. Preset "standby period" 0S
3. Press MW/PIR button 3 times till MW/PIR icons both blinking on LCD screen, daylight harvesting function enabled.

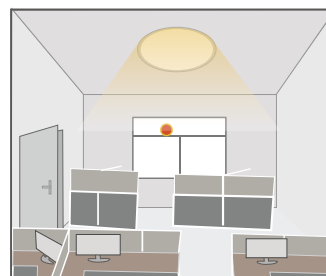
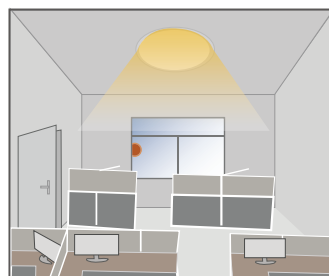
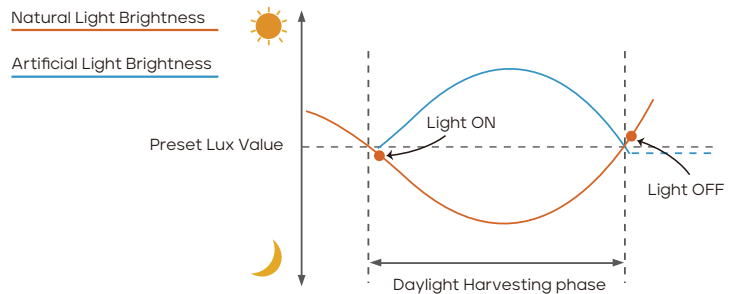

When ambient brightness is lower than preset lux level, sensor will turn on light automatically and keep dimming according to the change of the ambient brightness; when outside is getting darker, the inside will be brighter, and brighter darker.

Light OFF when ambient brightness becomes higher than the preset lux level.

PERFORMANCE

2. DUSK/DAWN FUNCTION

Our sensor is able to differentiate artificial light brightness from natural light after installed inside the fixture, and automatically turn off light when ambient brightness exceeds preset lux level.

PRECONDITION OF DUSK/DAWN FUNCTION:

1. Standby period is $+\infty$;
2. Standby dimming level is on 10%,20% or 30%;
3. Daylight threshold is on 30lux/50lux/80lux/120lux/200Lux/250Lux/300Lux/350Lux/400Lux

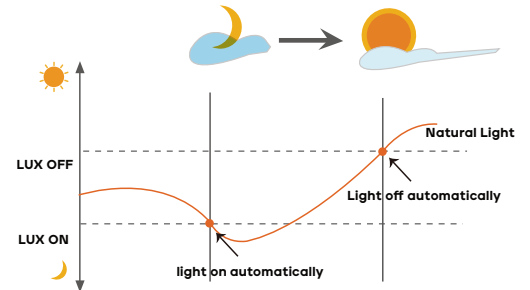

3. WITH DUSK/DAWN FUNCTION



With insufficient ambient brightness, sensor turns on light and keeps it at standby dimming level even if there is no motion or presence.

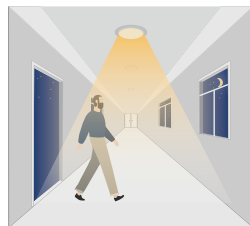

When sensor detects motion or presence it will bring the light level up to 100%.

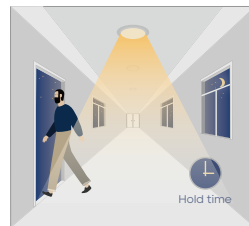

After motion is no longer detected, fixture remains at 100% for hold time.

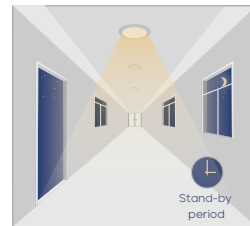

After pre-set hold time period it will dim light to standby dimming level again and always keep it.

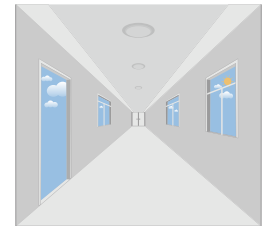

With sufficient ambient brightness, sensor will turn OFF light automatically.

4. WITHOUT DAYLIGHT DISABLED

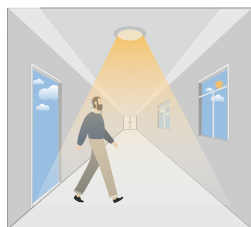

Sensor turns ON light when motion is detected.

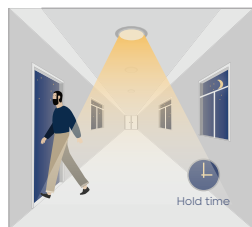

Sensor keeps for a hold time period after motion leaves

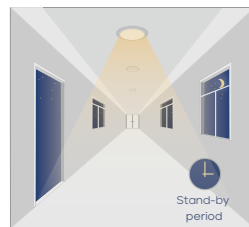

Sensor dims light to standby dimming level after hold time if there is still no motion

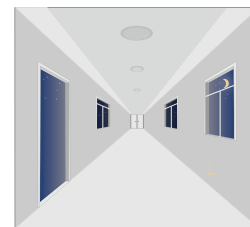

Sensor turns OFF light after standby period

5. WITH DAYLIGHT THRESHOLD

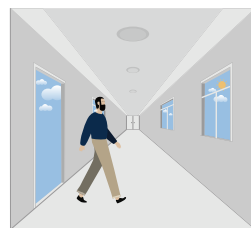

With sufficient daylight the sensor keeps light OFF even motion gets detected

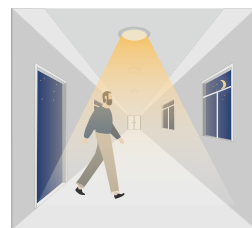

With insufficient daylight, the sensor turns light ON when motion gets detected

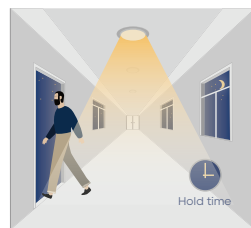

After there's no motion detected, the sensor keeps light ON 100% for holdtime.

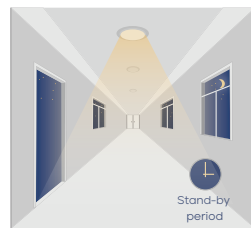

After hold time, sensor dims light to standby dimming level for standby period. if the standby period has been set as 0s, sensor turns light OFF automatically after holdtime.



The sensor turns OFF light automatically after the stand by period when there's no motion detected.