

LED SPOTLIGHT CANLESS RECESSED GIMBAL - 5CCT SELECTABLE 2", 3", 4" - BLACK & WHITE

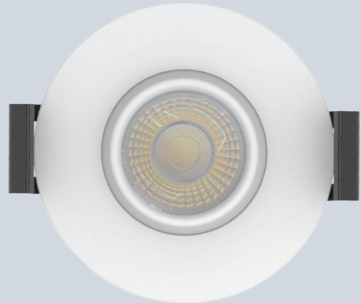

LR23300

2"

6W 400 LUMENS

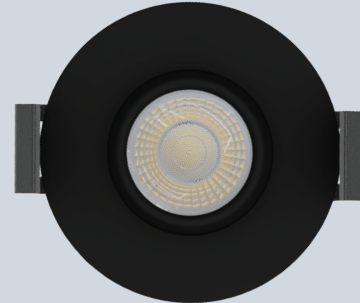

LR23301

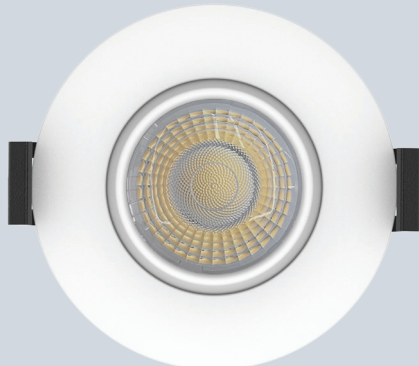

LR23302

3"

9W 730 LUMENS

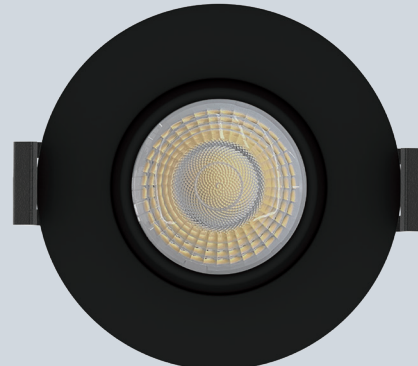

LR23303

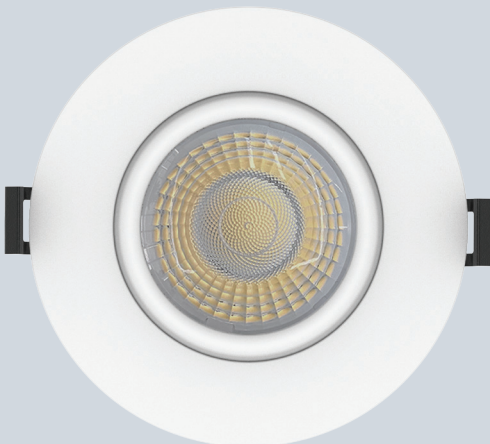

LR23304

4"

15W 1250 LUMENS

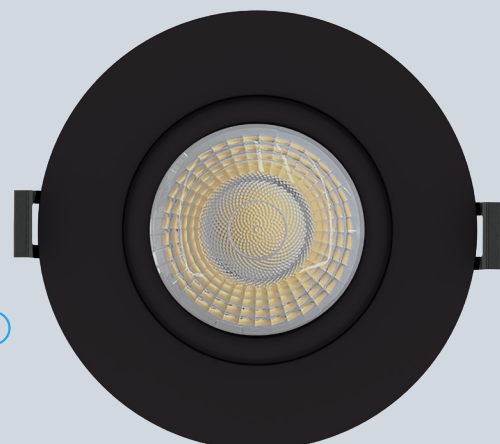

LR23305



COLOR SELECTABLE

2700K 3000K 3500K 4000K 5000K



ELECTRICAL

		MODEL	DESCRIPTION	POWER	INPUT VOLTS	EFFICACY	DIMMABLE	FLOOD	LIFETIME	COST/YR
2"	WHITE	LR23300	LED6W/DL2/GB/5CCT/RD/WT	6	120V	66	TRIAC	38°	50,000	\$ 0.72
	BLACK	LR23301	LED6W/DL2/GB/5CCT/RD/BK	6	120V	66	TRIAC	38°	50,000	\$ 0.72
3"	WHITE	LR23302	LED9W/DL3/GB/5CCT/RD/WT	9	120V	83	TRIAC	38°	50,000	\$ 1.08
	BLACK	LR23303	LED9W/DL3/GB/5CCT/RD/BK	9	120V	83	TRIAC	38°	50,000	\$ 1.08
4"	WHITE	LR23304	LED15W/DL4/GB/5CCT/RD2/WT	15	120V	83	TRIAC	38°	50,000	\$1.80
	BLACK	LR23305	LED15W/DL4/GB/5CCT/RD2/BK	15	120V	83	TRIAC	38°	50,000	\$1.80

PHOTOMETRIC

MODEL	DESCRIPTION	COLOR (CCT)	TEMP	LUMEN	CRI	ETL	TITLE 24	ENERGY STAR	PLATE (KNOCKOUT)
LR23300	LED6W/DL2/GB/5CCT/RD/WT	2700K/3000K/3500K/4000K/5000K	CCT SELECT	400	90	YES	YES		LR41004 (#0) LR41006 (#0) LR41010 (L0) LR41011 (#0)
LR23301	LED6W/DL2/GB/5CCT/RD/BK	2700K/3000K/3500K/4000K/5000K	CCT SELECT	400	90	YES	YES		
LR23302	LED9W/DL3/GB/5CCT/RD/WT	2700K/3000K/3500K/4000K/5000K	CCT SELECT	730	90	YES	YES	YES	
LR23303	LED9W/DL3/GB/5CCT/RD/BK	2700K/3000K/3500K/4000K/5000K	CCT SELECT	730	90	YES	YES	YES	LR41002 (#0) LR41006 (#1)
LR23304	LED15W/DL4/GB/5CCT/RD2/WT	2700K/3000K/3500K/4000K/5000K	CCT SELECT	1250	90	YES	YES	YES	LR41002 (#1) LR41006 (#3) LR41010 (R1) LR41011 (#4)
LR23305	LED15W/DL4/GB/5CCT/RD2/BK	2700K/3000K/3500K/4000K/5000K	CCT SELECT	1250	90	YES	YES	YES	

COMPATIBILITY

COMPATIBLE WITH:

LR35126
Emergency LED Driver



LR41004
New Construction Mounting Plate

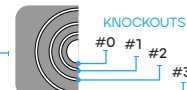
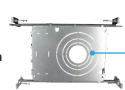

KNOCKOUT SIZE	
#0	Ø2.125" (Ø54 mm)
#1	Ø2.83" (Ø72 mm)
#2	Ø3.75" (Ø95 mm)
#3	Ø5.19" (Ø132 mm)

LR41006
New Construction Mounting Plate



KNOCKOUT SIZE	
#0	Ø2.12" (Ø54 mm)
#1	Ø3.15" (Ø80 mm)
#2	Ø3.75" (Ø95 mm)
#3	Ø4.25" (Ø108 mm)
#4	Ø5.25" (Ø132 mm)
#5	Ø6.25" (Ø159 mm)

LR41011
New Construction Mounting Plate

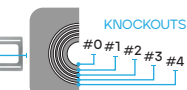
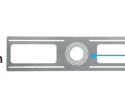

KNOCKOUT SIZE	
#0	Ø2.48" (Ø63 mm)
#1	Ø2.83" (Ø72 mm)
#2	Ø3.34" (Ø85 mm)
#3	Ø3.74" (Ø95 mm)
#4	Ø4.25" (Ø108 mm)

LR41002
New Construction Mounting Plate

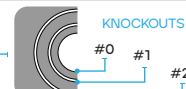
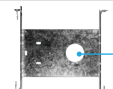

KNOCKOUT SIZE	
#0	Ø3.14" (Ø80 mm)
#1	Ø4.33" (Ø110 mm)
#2	Ø6.29" (Ø160 mm)

LR41010
New Construction Mounting Plate



KNOCKOUT SIZE	
#L0	Ø2.12" (Ø54 mm)
#L1	Ø2.83" (Ø72 mm)
#L2	Ø3.75" (Ø95 mm)



KNOCKOUT SIZE	
#R0	Ø3.25" (Ø82 mm)
#R1	Ø4.33" (Ø110 mm)
#R2	Ø5.25" (Ø132 mm)
#R3	Ø6.25" (Ø160 mm)

DIMENSIONS

2"
CUTOUT: Ø 2.16"

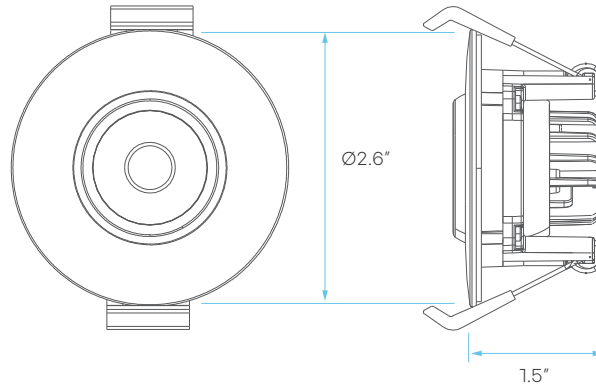

3"
CUTOUT: Ø3"

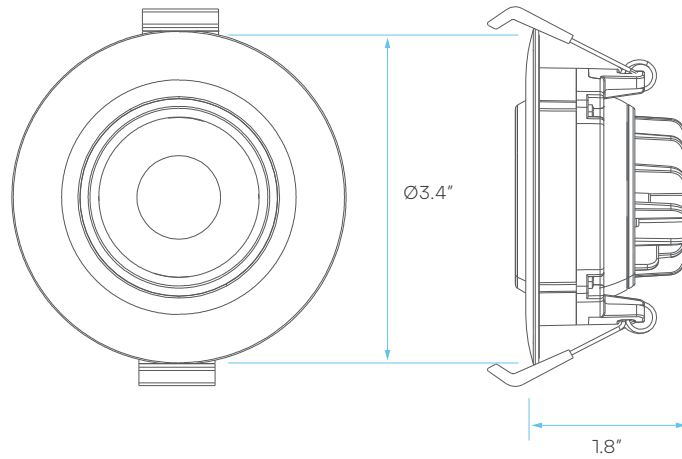

4"
CUTOUT: Ø4.31"

