

Dimmable Aurora Frontlit Mirror 24 X 32



DESCRIPTION

Aurora Mirror is a sleek front-lit LED mirror that provides bright, even illumination for a clear, shadow-free reflection. Designed for both style and function, it features a built-in 3x magnifier for precision tasks like grooming and makeup application, making it a refined addition to any modern space.

FEATURES & BENEFITS

- Integrated 3x magnifier
- Energy efficient LED technology
- Front-lit
- Dimmable
- LED Lifetime: Approx. 120,000 hours
- Copper-free, silver-backed glass
- Hangs vertically or horizontally
- 5 year warranty

AVAILABLE LED OPTIONS

- 3000K LED Strip
- 6000K LED Strip
- CCT Selectible (Touch Sensor) - 3000K, 4000K, 6000K
- RGBW LED with Remote Control

SPECIFICATIONS

- **Dimensions:** 24" x 32"
- **Weight:** 22 Lbs
- **Ingress Protection Rating:** IP44
- **Input Voltage:** Hardwire 110V
- **Color Rendering Index:** CRI 90+
- **Power Requirement:** 45W
- **Brightness:** 4970 Lumens

SAFETY SPECIFICATIONS

- Entire assembly meets UL/cUL standards
- International Certifications



Dimmable Aurora Frontlit Mirror 24 X 32

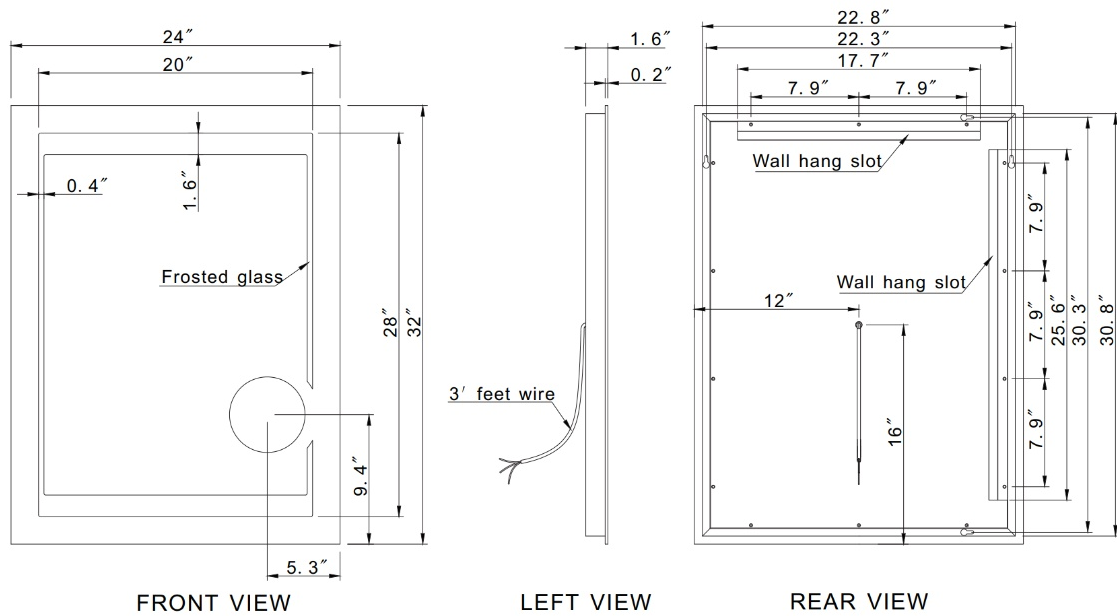

INSTALLATION

- Hold the Z-bar on the wall, level it, and mark screw points.
- Drill pilot holes; add wall anchors if not hitting a stud. Install Z-bar (wall piece) – Screw it firmly into place and keep it level.
- Hook the mirror's pre-installed bracket over the wall cleat.
- Match & attach 3 electrical wires from mirror to home electrical wires: Live to Live, Ground to Ground, Neutral to Neutral.

CARE & SAFETY

- Wear suitable eye wear protection when drilling. Use caution when using power tools near water, beware of hidden cables or pipes.
- Be cautious if drilling on tiled surfaces in case the drill slips. Applying a piece of masking tape on the wall before marking out fixing holes can help stopping the drill from moving.

CLEANING & MAINTENANCE

- It is recommended to clean the unit with a soft, dry, non-abrasive cloth when turned off.
- Never use cleaning agents or abrasive material on any type of surface finish.
- Do not strike glass components with hard or pointy items.
- Do not place very hot or cold items against or in close proximity to glass surfaces.