

UNIVERSAL MOUNT LED 2.5" CYLINDER SYSTEM - 5 CCT SELECTABLE UNIVERSAL VOLTAGE/DUAL DIMMING (TRIAC/0-10V)



LR43723
BLACK FINISH

LR43720
WHITE FINISH

UNIVERSAL MOUNT
OPTIONS AVAILABLE*

SCAN TO EXPLORE

RECESSED
SURFACE
PENDANT
TRACK
WALL



UNIVERSAL MOUNT OPTIONS AVAILABLE*

WALL MOUNT OPTIONS*



RECESSED MOUNT OPTIONS*



SURFACE MOUNT OPTIONS*



SNOOT OPTIONS

CYLINDER SNOOT

WALL WASHER SNOOT



LR43741 LR43742



LR43743 LR43744

EXTENDER OPTIONS



LR43745 LR43746

45° ADJUSTABLE EXTENDER



LR43753 LR43754

H-TRACK ADAPTER OPTIONS*



LR43757 LR43758 LR43747 LR43748

*COMPATIBLE WITH
TRACKRITE



COLOR SELECTABLE

2700K 3000K 3500K 4000K 5000K



*ALL ACCESSORIES ARE SOLD SEPARATELY

ELECTRICAL

		MODEL	DESCRIPTION	POWER	INPUT VOLTS	EFFICACY	DIMMABLE	LIFETIME	COST/YR
2.5"	WHITE	LR43720	LEDCYL2.5/15W/5CCT/FL38/UNV/DD/WT	15	120-277V	73	TRIAC/0-10V	50,000	\$ 1.80
	BLACK	LR43723	LEDCYL2.5/15W/5CCT/FL38/UNV/DD/BK	15	120-277V	73	TRIAC/0-10V	50,000	\$ 1.80

PHOTOMETRIC

MODEL	DESCRIPTION	COLOR (CCT)	TEMP	LUMEN	FLOOD	CRI	ETL LISTED
LR43720	LEDCYL2.5/15W/5CCT/FL38/UNV/DD/WT	2700K/3000K/3500K/4000K/5000K	CCT SELECT	1100	38°	90	YES
LR43723	LEDCYL2.5/15W/5CCT/FL38/UNV/DD/BK	2700K/3000K/3500K/4000K/5000K	CCT SELECT	1100	38°	90	YES

DIMENSIONS

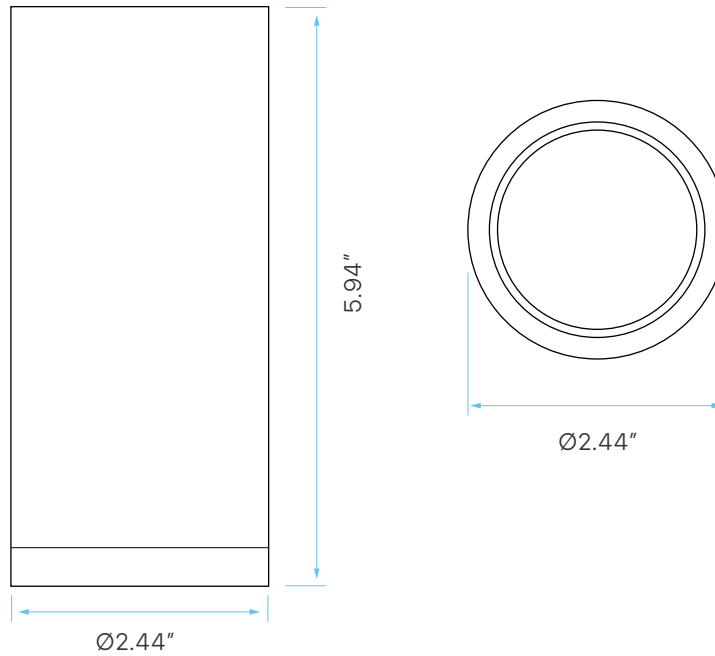

2.5" CYLINDER - LENS OPTIONS

*SOLD SEPARATELY



15° LENS

MODEL	DESCRIPTION	FLOOD
LR43749	LEDCYL2.5/LENS/FL15	15°

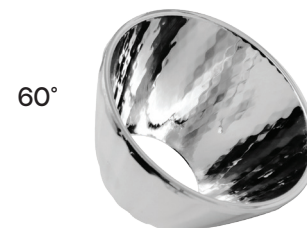

60° LENS

MODEL	DESCRIPTION	FLOOD
LR43750	LEDCYL2.5/LENS/FL60	60°

2.5" CYLINDER - 1-HEAD WALL MOUNT

*SOLD SEPARATELY

LR43725



LR43726



DIMENSIONS

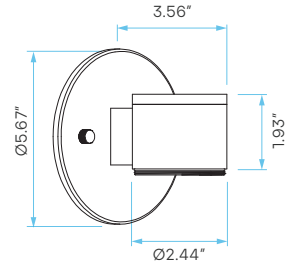

ASSEMBLED VIEW

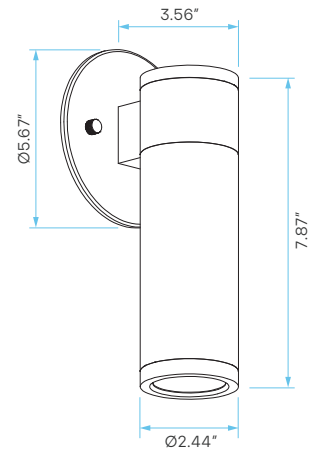

1-HEAD WALL MOUNT

MODEL	DESCRIPTION	FINISH
LR43725	LEDCYL2.5/WMOUNT/1HD/WT	WHITE
LR43726	LEDCYL2.5/WMOUNT/1HD/BK	BLACK

2.5" CYLINDER - 2-HEAD WALL MOUNT

*SOLD SEPARATELY

LR43727



LR43728



DIMENSIONS

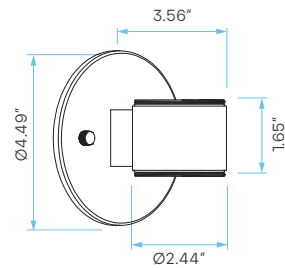

ASSEMBLED VIEW

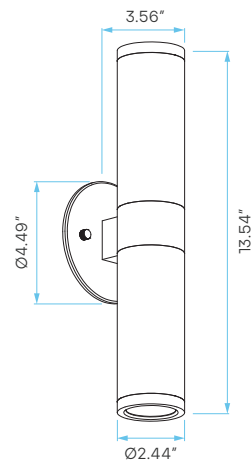

2-HEAD WALL MOUNT

MODEL	DESCRIPTION	FINISH
LR43727	LEDCYL2.5/WMOUNT/2HD/WT	WHITE
LR43728	LEDCYL2.5/WMOUNT/2HD/BK	BLACK

2.5" CYLINDER - H TRACK ADAPTER

*SOLD SEPARATELY



DIMENSIONS

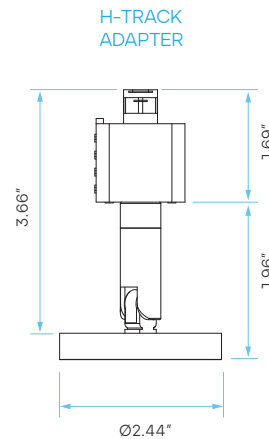

ASSEMBLED VIEW

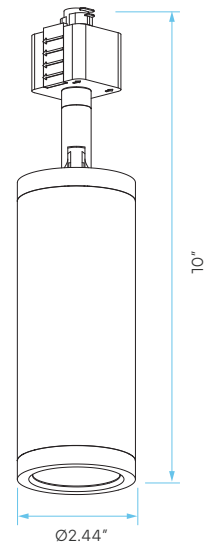

H-TRACK ADAPTER

MODEL	DESCRIPTION	FINISH
LR43747	LEDCYL2.5/HTRACK/WT	WHITE
LR43748	LEDCYL2.5/HTRACK/BK	BLACK

2.5" CYLINDER - 8' ADJUSTABLE CABLE H TRACK ADAPTER

*SOLD SEPARATELY



DIMENSIONS

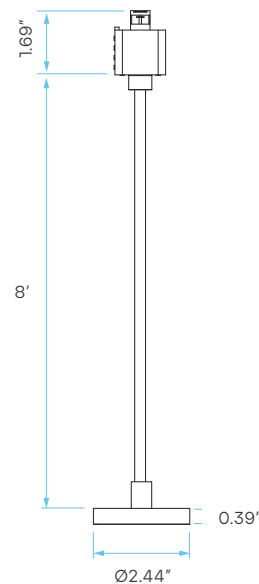

ASSEMBLED VIEW

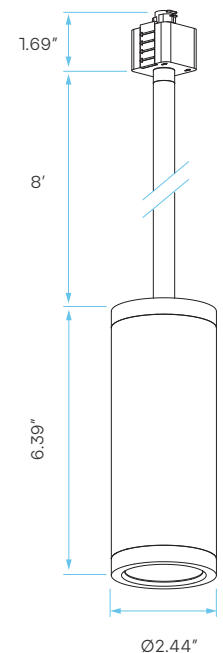

H-TRACK ADAPTER

MODEL	DESCRIPTION	FINISH
LR43757	LEDCYL2.5/HTRACK/8FTCBL/WT	WHITE
LR43758	LEDCYL2.5/HTRACK/8FTCBL/BK	BLACK

2.5" CYLINDER - TRIMLESS MOUNT

*SOLD SEPARATELY

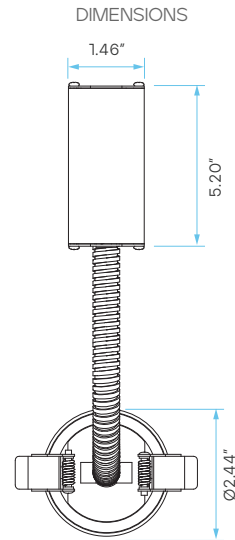

CUTOUT: Ø2"

ASSEMBLED VIEW

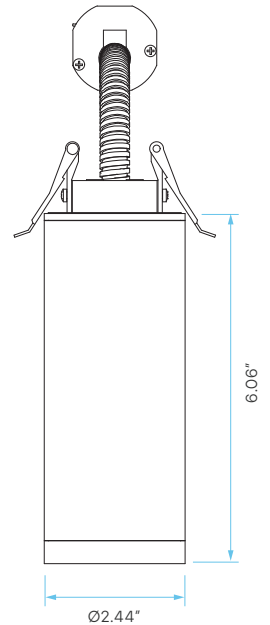

TRIMLESS MOUNT

MODEL	DESCRIPTION	FINISH
LR43729	LEDCYL2.5/RMOUNT/WT	WHITE
LR43730	LEDCYL2.5/RMOUNT/BK	BLACK

PLATE COMPATIBILITY

PLATE	CUTOUT	KNOCKOUT SIZE
LR41006	#0	Ø2.125" (Ø54 mm)
LR41004	#0	Ø2.125" (Ø54 mm)
LR41010	#L0	Ø2.125" (Ø54 mm)

2.5" CYLINDER - RECESSED MOUNT 8FT CABLE

*SOLD SEPARATELY

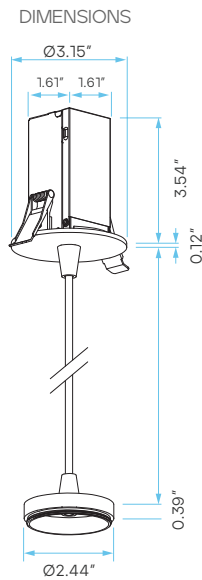

CUTOUT: Ø2.63"

ASSEMBLED VIEW

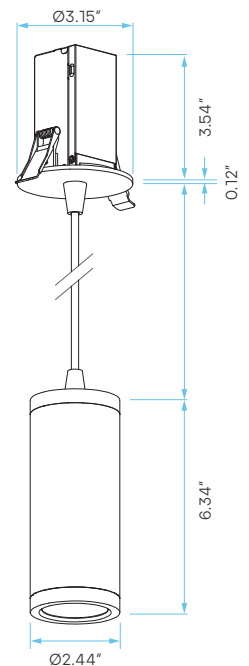

RECESSED MOUNT - 8FT CABLE

MODEL	DESCRIPTION	FINISH
LR43731	LEDCYL2.5/RMOUNT/8FTCBL/WT	WHITE
LR43732	LEDCYL2.5/RMOUNT/8FTCBL/BK	BLACK

PLATE COMPATIBILITY

PLATE	CUTOUT	KNOCKOUT SIZE
LR41004	#0	Ø2.83" (Ø72 mm)
LR41010	#L1	Ø2.83" (Ø72 mm)

2.5" CYLINDER - RECESSED MOUNT 1FT CABLE

*SOLD SEPARATELY



RECESSED MOUNT 1FT CABLE

MODEL	DESCRIPTION	FINISH
LR43739	LEDCYL2.5/RMOUNT/1FTCBL/WT	WHITE
LR43740	LEDCYL2.5/RMOUNT/1FTCBL/BK	BLACK

DIMENSIONS

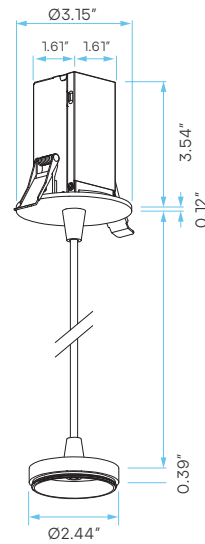

CUTOUT: Ø2.63"

PLATE COMPATIBILITY

PLATE	CUTOUT	KNOCKOUT SIZE
LR41004	#0	Ø2.83" (Ø72 mm)
LR41010	#L1	Ø2.83" (Ø72 mm)

ASSEMBLED VIEW

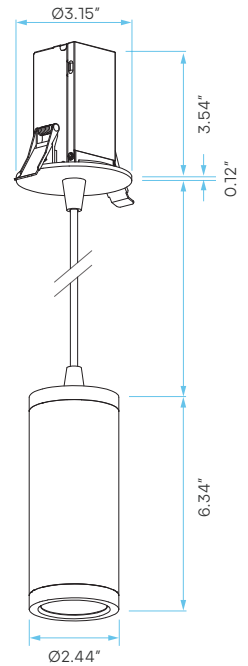

2.5" CYLINDER - SURFACE MOUNT 1FT CABLE

*SOLD SEPARATELY



SURFACE MOUNT 1FT CABLE

MODEL	DESCRIPTION	FINISH
LR43737	LEDCYL2.5/SMOUNT/1FTCBL/WT	WHITE
LR43738	LEDCYL2.5/SMOUNT/1FTCBL/BK	BLACK

DIMENSIONS

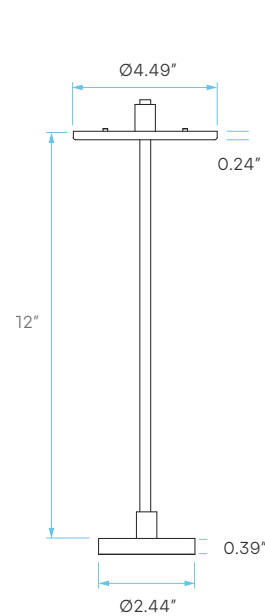

ASSEMBLED VIEW

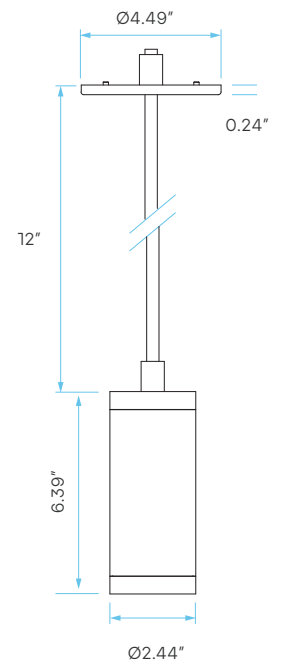

2.5" CYLINDER - SURFACE MOUNT 8FT CABLE

*SOLD SEPARATELY



DIMENSIONS

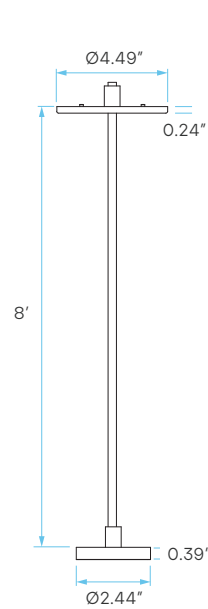

ASSEMBLED VIEW

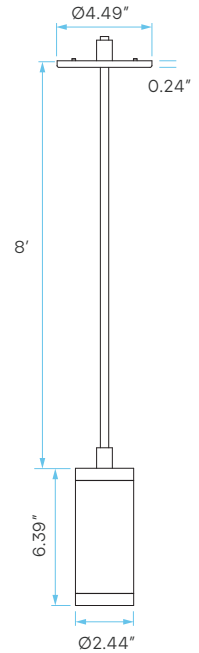

SURFACE MOUNT 8FT CABLE

MODEL	DESCRIPTION	FINISH
LR43751	LEDCYL2.5/SMOUNT/8FTCBL/WT	WHITE
LR43752	LEDCYL2.5/SMOUNT/8FTCBL/BK	BLACK

2.5" CYLINDER - SURFACE MOUNT 1FT STEM

*SOLD SEPARATELY



DIMENSIONS

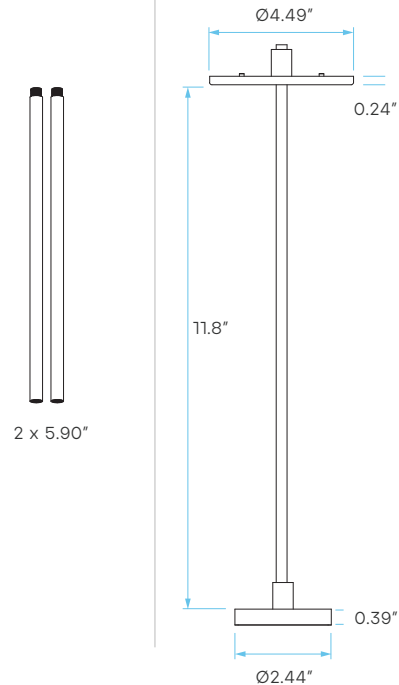

ASSEMBLED VIEW

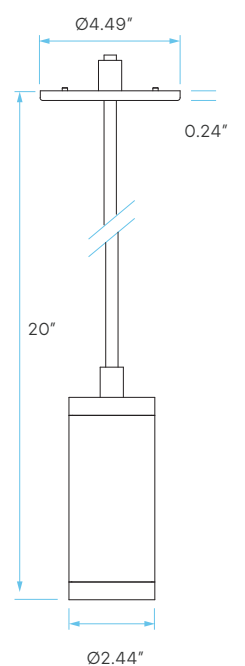

SURFACE MOUNT 6FT ADJUSTABLE STEM

MODEL	DESCRIPTION	FINISH
LR43770	LEDCYL2.5/SMOUNT/1FTSTEM/WT	WHITE
LR43771	LEDCYL2.5/SMOUNT/1FTSTEM/BK	BLACK

2.5" CYLINDER - SURFACE MOUNT 6FT ADJUSTABLE STEM

*SOLD SEPARATELY



ADJUSTABLE

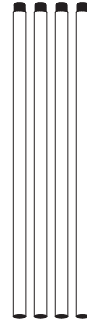

4 x 11.81"



2 x 5.90"

DIMENSIONS

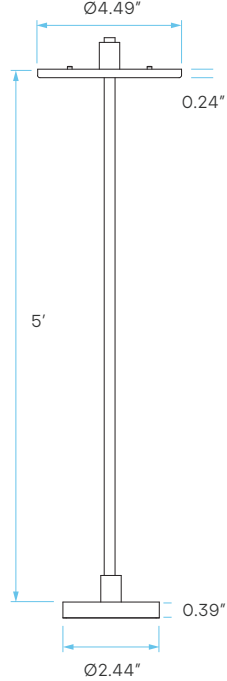

ASSEMBLED VIEW

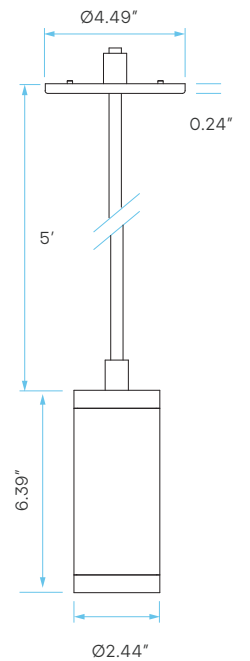

SURFACE MOUNT 6FT ADJUSTABLE STEM

MODEL	DESCRIPTION	FINISH
LR43755	LEDCYL2.5/SMOUNT/6FTASTEM/WT	WHITE
LR43756	LEDCYL2.5/SMOUNT/6FTASTEM/BK	BLACK

2.5" CYLINDER - SURFACE MOUNT PLATE

*SOLD SEPARATELY



LR43733

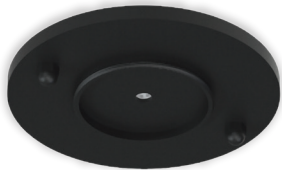

LR43734



DIMENSIONS

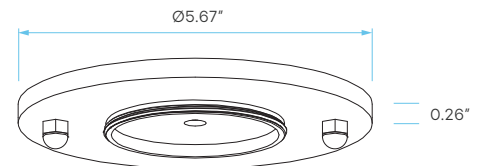

ASSEMBLED VIEW

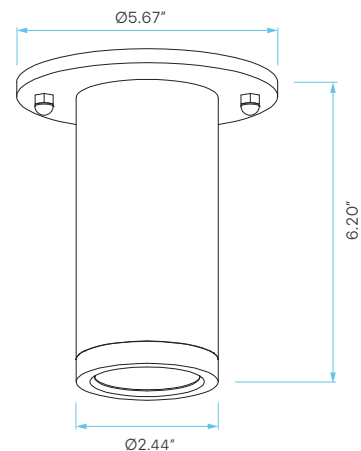

SURFACE MOUNT PLATE

MODEL	DESCRIPTION	FINISH
LR43733	LEDCYL2.5/SMOUNT/WT	WHITE
LR43734	LEDCYL2.5/SMOUNT/BK	BLACK

2.5" CYLINDER - SURFACE MOUNT MONOPOINT

*SOLD SEPARATELY



DIMENSIONS

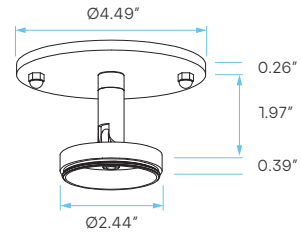

ASSEMBLED VIEW

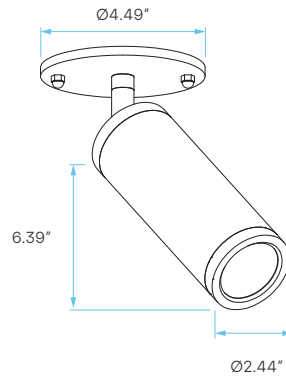

SURFACE MOUNT MONOPOINT

MODEL	DESCRIPTION	FINISH
LR43735	LEDCYL2.5/SMOUNT/MONO/WT	WHITE
LR43736	LEDCYL2.5/SMOUNT/MONO/BK	BLACK

2.5" CYLINDER - 45° ADJUSTABLE EXTENDER

*SOLD SEPARATELY



DIMENSIONS

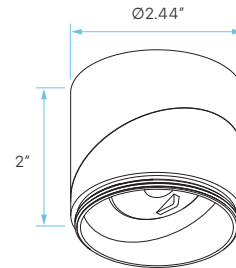

ASSEMBLED VIEW

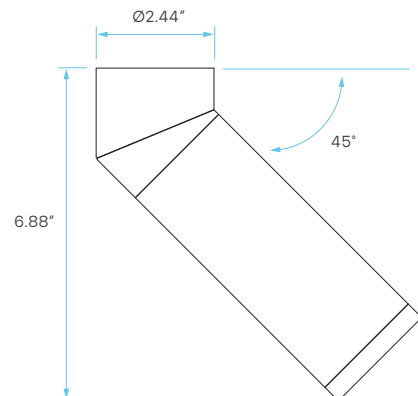

45° ADJUSTABLE EXTENDER

MODEL	DESCRIPTION	FINISH
LR43753	LEDCYL2.5/EXT/A45D/WT	WHITE
LR43754	LEDCYL2.5/EXT/A45D/BK	BLACK

2.5" CYLINDER - WALL WASHER SNOOT

*SOLD SEPARATELY

LR43743



LR43744



DIMENSIONS

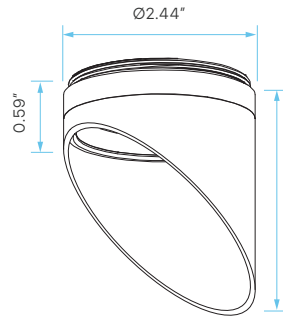

ASSEMBLED VIEW

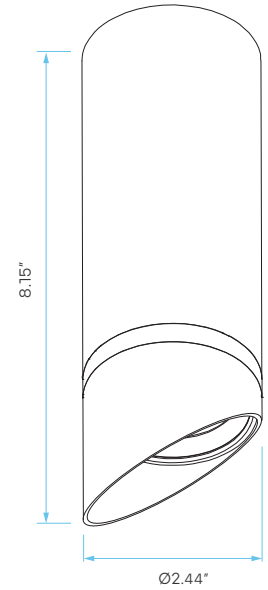

CYLINDER WALL WASHER SNOOT

MODEL	DESCRIPTION	FINISH
LR43743	LEDCYL2.5/WWSNOOT2/WT	WHITE
LR43744	LEDCYL2.5/WWSNOOT2/BK	BLACK

2.5" CYLINDER - EXTENDER

*SOLD SEPARATELY

LR43745



LR43746



DIMENSIONS

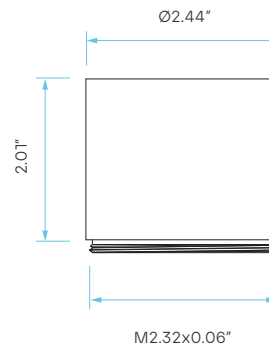

ASSEMBLED VIEW

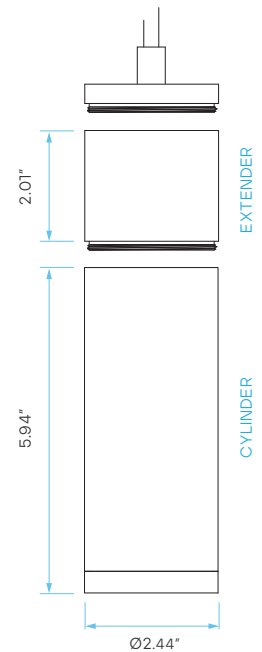

CYLINDER EXTENDER

MODEL	DESCRIPTION	FINISH
LR43745	LEDCYL2.5/EXT2/WT	WHITE
LR43746	LEDCYL2.5/EXT2/BK	BLACK

2.5" CYLINDER - SNOOT

*SOLD SEPARATELY



LR43741



LR43742



DIMENSIONS

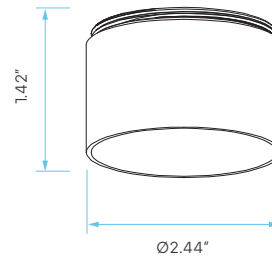

ASSEMBLED VIEW

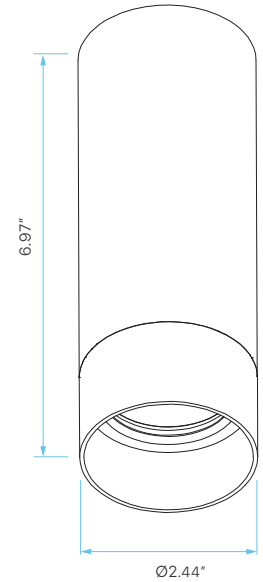

CYLINDER SNOOT

MODEL	DESCRIPTION	FINISH
LR43741	LEDCYL2.5/SNOOT1/WT	WHITE
LR43742	LEDCYL2.5/SNOOT1/BK	BLACK