

KT-CLEDXXPS-X1-8CSB-VDIM-X

LED SQUARE CANOPY LIGHT FIXTURE

DESCRIPTION

General Purpose LED Square Canopy Light | Power Select | Color Select | 120–277V Input | Bronze or White Housing

APPLICATION

Ceiling mounted outdoor illumination needs, such as parking garages, covered walkways, entrance areas, etc.



10 YEAR
LIMITED WARRANTY



PRODUCT FEATURES

- Keystone Power Select technology (*See Performance Specifications chart below*)
- Keystone Color Select technology (3000/4000/5000K)
- Familiar, low profile design ideal for a wide range of new and replacement installations
- Heavy-duty die-cast aluminum housing with a modern aesthetic and (3) 1/2" NPT threaded conduit hubs
- Suitable for standard junction box mounting or 3/4" NPT pendant mounting
- Built-in dusk-to-dawn photocell behind translucent 3/4" threaded plug with anti-yellowing agent
- Impact-resistant, polycarbonate diffuser with 160° parking garage distribution. Perfect for low mounting applications
- Optional 110° canopy distribution diffuser available. Perfect for high mounting applications
- Compatible with KTS-MW3-12V-PKO, quick install bi-level occupancy sensor accessory available
- Compatible with KTSL-FC4-12V-PKO, SmartLoop Bluetooth wireless controller accessory available
- Powered by Keystone LED 0–10V dimming driver
- Ambient operating temperature: –40°C/–40°F to 50°C/122°F
- UL certified for wet locations, IP65 rated
- Power Factor: > 0.95
- THD: < 20%
- L70 @ > 100,000 hrs @ 25°C/77°F ambient fixture temperature
- Meets FCC Part 15, Part B, Class A standards for conducted and radiated emissions

PRODUCT IMAGES



KT-CLED40PS-S1-8CSB-VDIM
KT-CLED25PS-S1-8CSB-VDIM

KT-CLED40PS-S1-8CSB-VDIM-W

KT-CLED60PS-M1-8CSB-VDIM

KT-CLED60PS-M1-8CSB-VDIM-W

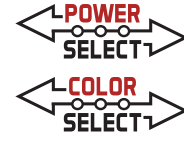

KT-CLEDXXPS-X1-8CSB-VDIM-X

LED SQUARE CANOPY LIGHT FIXTURE

PERFORMANCE SPECIFICATIONS

Catalog Number	Selectable Wattage	Selectable CCT	Lumens	Efficacy	Input Voltage	Dimming	CRI	Distribution Pattern	Photocell Included	Nominal Size	Housing Color	Legacy Equivalent
KT-CLED60PS-M1-8CSB-VDIM KT-CLED60PS-M1-8CSB-VDIM-W	60W	3000K	7,500	125 lm/W	120-277V	0-10V	> 80	160° installed, 110° sold separately	Yes	10" square	Bronze or white	250W MH
		4000K	8,400	140 lm/W								
		5000K	7,800	130 lm/W								
	50W	3000K	6,250	125 lm/W								
		4000K	7,000	140 lm/W								
		5000K	6,500	130 lm/W								
	40W	3000K	5,000	125 lm/W								
		4000K	5,600	140 lm/W								
		5000K	5,200	130 lm/W								
KT-CLED40PS-S1-8CSB-VDIM KT-CLED40PS-S1-8CSB-VDIM-W	40W	3000K	5,000	125 lm/W	120-277V	0-10V	> 80	160° installed, 110° sold separately	Yes	8" square	Bronze or white	175W MH
		4000K	5,600	140 lm/W								
		5000K	5,200	130 lm/W								
	30W	3000K	3,750	125 lm/W								
		4000K	4,200	140 lm/W								
		5000K	3,900	130 lm/W								
	20W	3000K	2,500	125 lm/W								
		4000K	2,800	140 lm/W								
		5000K	2,600	130 lm/W								
KT-CLED25PS-S1-8CSB-VDIM	25W	3000K	3,125	125 lm/W	120-277V	0-10V	> 80	160° installed, 110° sold separately	Yes	8" square	Bronze	100W MH
		4000K	3,500	140 lm/W								
		5000K	3,250	130 lm/W								
	20W	3000K	2,500	125 lm/W								
		4000K	2,800	140 lm/W								
		5000K	2,600	130 lm/W								
	15W	3000K	1,875	125 lm/W								
		4000K	2,100	140 lm/W								
		5000K	1,950	130 lm/W								

Note: Preset to highest wattage and 5000K
 Note: Color uniformity: CCT (Correlated Color Temperature) range as per guidelines outlined in ANSI C78.377-2017

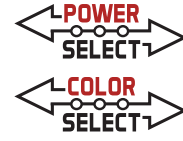

KT-CLEDXXPS-X1-8CSB-VDIM-X

LED SQUARE CANOPY LIGHT FIXTURE

PHOTOMETRIC SPECIFICATIONS

KT-CLED60PS-M1-8CSB-VDIM | KT-CLED60PS-M1-8CSB-VDIM-W | 160°

ISOCANDELA PLOT

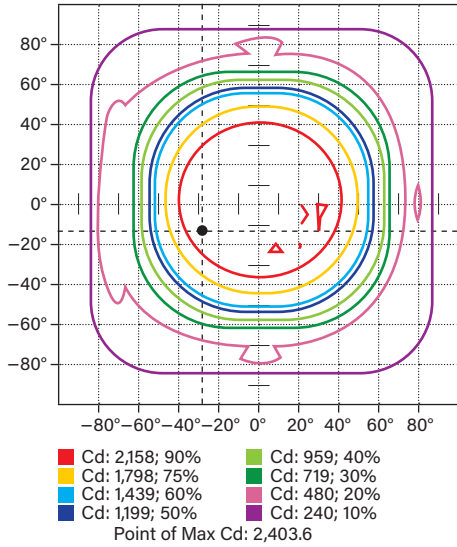

POLAR CANDELA DISTRIBUTION

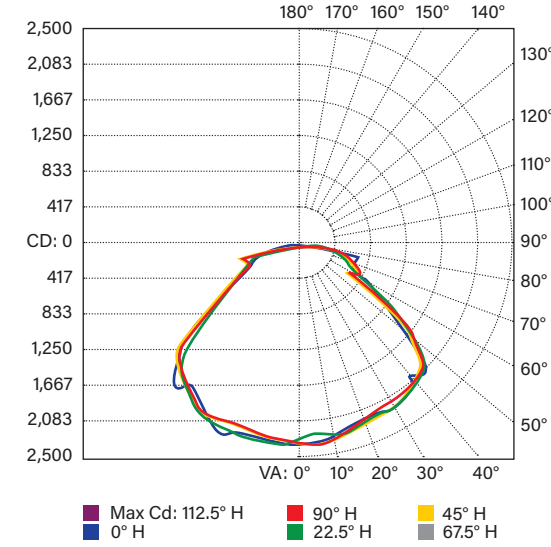

ZONAL LUMEN SUMMARY

Zone	Lumens	% Luminaire
0-30	1,903.5	24.7%
0-40	3,296.9	42.8%
0-60	5,945.7	77.2%
60-90	1,530.4	19.9%
70-100	887.7	11.5%
90-120	180.4	2.3%
0-90	7,476.1	97.0%
90-180	229.2	3.0%
0-180	7,705.3	100%

KT-CLED40PS-S1-8CSB-VDIM | KT-CLED40PS-S1-8CSB-VDIM-W | 160°

ISOCANDELA PLOT

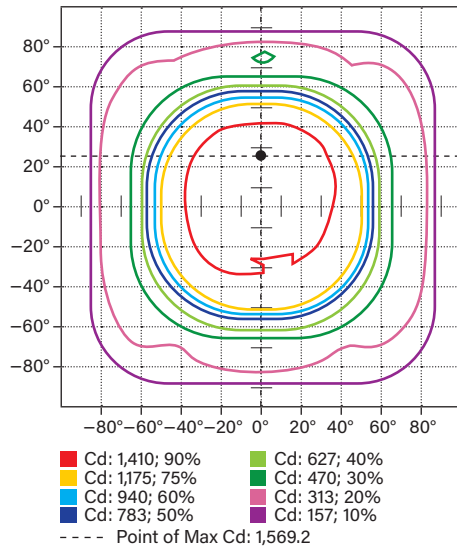

POLAR CANDELA DISTRIBUTION

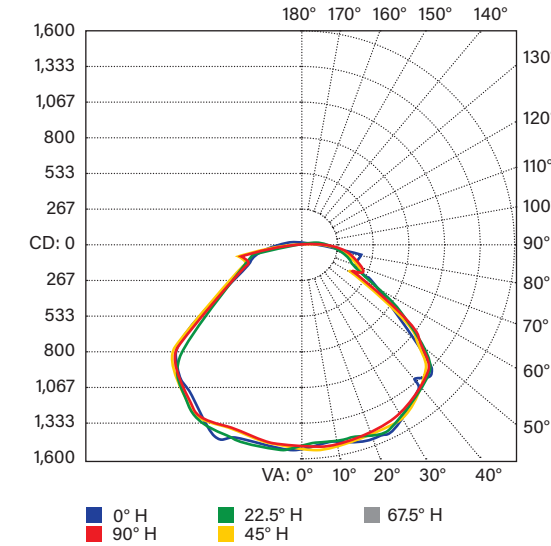

ZONAL LUMEN SUMMARY

Zone	Lumens	% Luminaire
0-30	1,238.1	23.2%
0-40	2,137.9	40.1%
0-60	3,992.1	74.9%
60-90	1,137.1	21.3%
70-100	702.5	13.2%
90-120	153.9	2.9%
0-90	5,129.2	96.2%
90-180	200.4	3.8%
0-180	5,329.6	100%

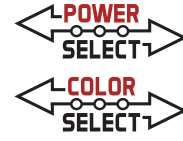

KT-CLEDXXPS-X1-8CSB-VDIM-X

LED SQUARE CANOPY LIGHT FIXTURE

PHOTOMETRIC SPECIFICATIONS (CONTINUED)

KT-CLED25PS-S1-8CSB-VDIM | 160°

ISOCANDELA PLOT

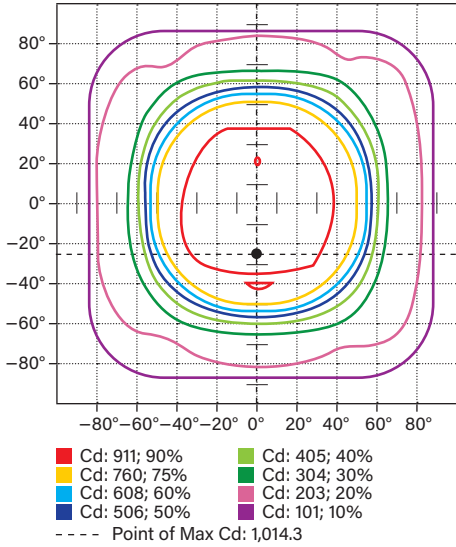

POLAR CANDELA DISTRIBUTION

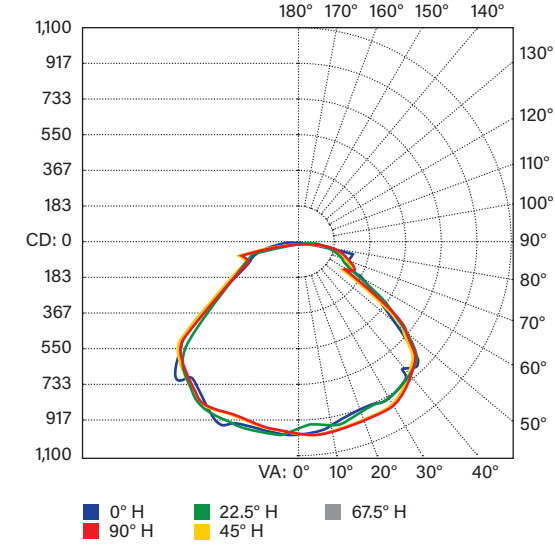

ZONAL LUMEN SUMMARY

Zone	Lumens	% Luminaire
0-30	804.7	23.3%
0-40	1,386.6	40.2%
0-60	2,576.9	74.7%
60-90	727.5	21.1%
70-100	448.4	13.0%
90-120	111.6	3.2%
0-90	3,304.4	95.8%
90-180	144.3	4.2%
0-180	3,448.7	100%

KT-CLED60PS-M1-8CSB-VDIM | KT-CLED60PS-M1-8CSB-VDIM-W | 110°

ISOCANDELA PLOT

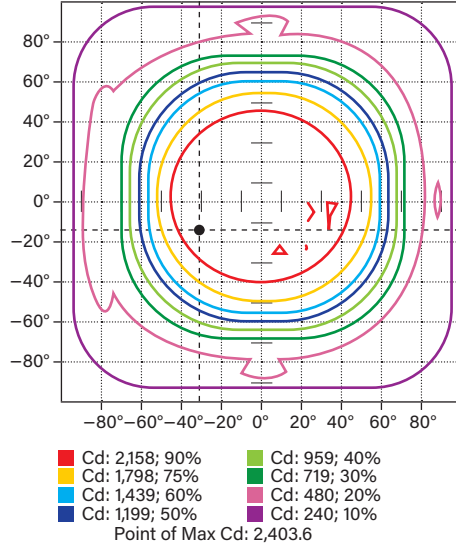

POLAR CANDELA DISTRIBUTION

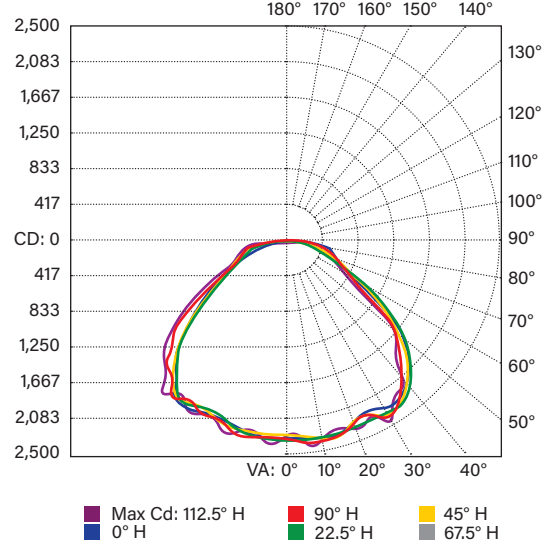

ZONAL LUMEN SUMMARY

Zone	Lumens	% Luminaire
0-30	1,903.5	24.7%
0-40	3,296.9	42.8%
0-60	5,945.7	77.2%
60-90	1,530.4	19.9%
70-100	887.7	11.5%
90-120	180.4	2.3%
0-90	7,476.1	97.0%
90-180	229.2	3.0%
0-180	7,705.3	100%

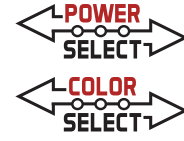

KT-CLEDXXPS-X1-8CSB-VDIM-X

LED SQUARE CANOPY LIGHT FIXTURE

PHOTOMETRIC SPECIFICATIONS (CONTINUED)

KT-CLED40PS-S1-8CSB-VDIM | KT-CLED40PS-S1-8CSB-VDIM-W | 110°

ISOCANDELA PLOT

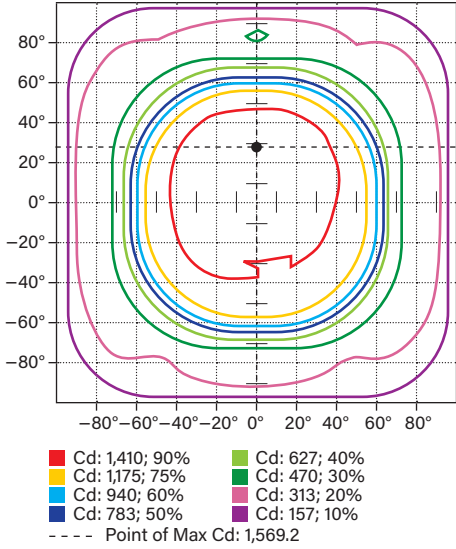

POLAR CANDELA DISTRIBUTION

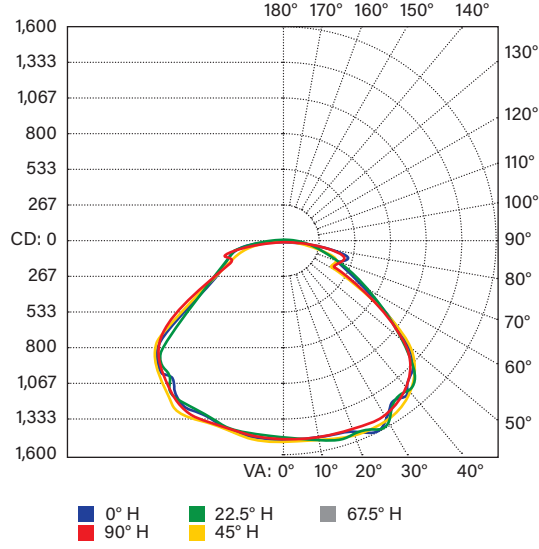

ZONAL LUMEN SUMMARY

Zone	Lumens	% Luminaire
0-30	1,238.1	23.2%
0-40	2,137.9	40.1%
0-60	3,992.1	74.9%
60-90	1,137.1	21.3%
70-100	702.5	13.2%
90-120	153.9	2.9%
0-90	5,129.2	96.2%
90-180	200.4	3.8%
0-180	5,329.6	100%

KT-CLED25PS-S1-8CSB-VDIM | 110°

ISOCANDELA PLOT

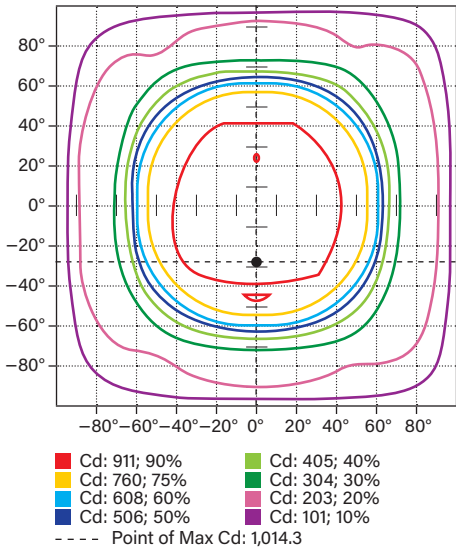

POLAR CANDELA DISTRIBUTION

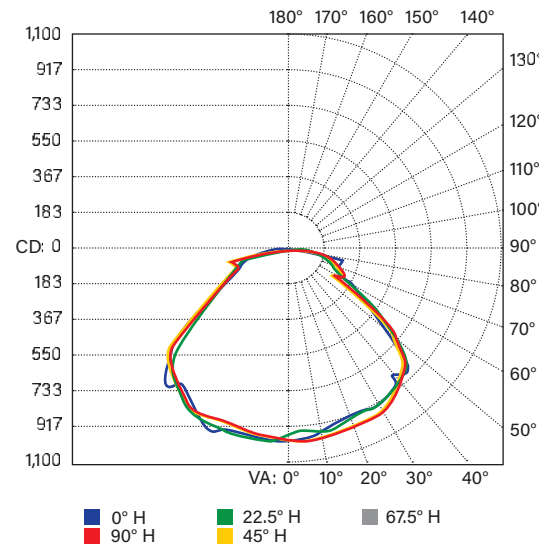

ZONAL LUMEN SUMMARY

Zone	Lumens	% Luminaire
0-30	804.7	23.3%
0-40	1,386.6	40.2%
0-60	2,576.9	74.7%
60-90	727.5	21.1%
70-100	448.4	13%
90-120	111.6	3.2%
0-90	3,304.4	95.8%
90-180	144.3	4.2%
0-180	3,448.7	100%

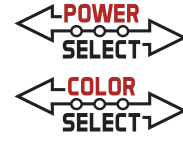

KT-CLEDXXPS-X1-8CSB-VDIM-X

LED SQUARE CANOPY LIGHT FIXTURE

PHOTOMETRIC SPECIFICATIONS (CONTINUED)

KT-CLED60PS-M1-8CSB-VDIM-X

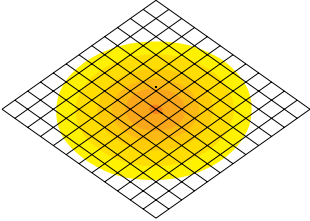

- 60W mounted at 17.5 ft
- 160° distribution
- Each square is 10 ft x 10 ft

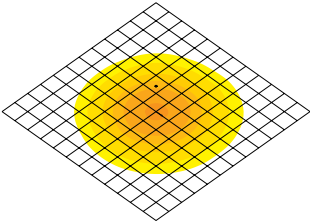

- 60W mounted at 20 ft
- 110° distribution
- Each square is 10 ft x 10 ft

KT-CLED40PS-S1-8CSB-VDIM-X

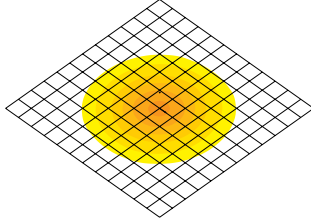

- 40W mounted at 12.5 ft
- 160° distribution
- Each square is 10 ft x 10 ft

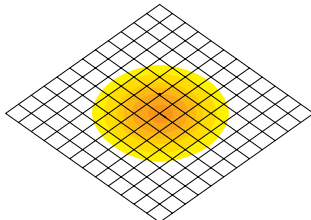

- 40W mounted at 15 ft
- 110° distribution
- Each square is 10 ft x 10 ft

KT-CLED25PS-S1-8CSB-VDIM

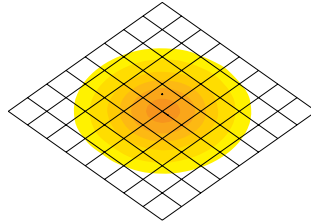

- 25W mounted at 12 ft
- 160° distribution
- Each square is 10 ft x 10 ft

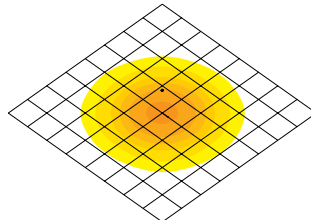

- 25W mounted at 9 ft
- 110° distribution
- Each square is 10 ft x 10 ft

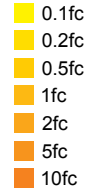

WIRING DIAGRAMS

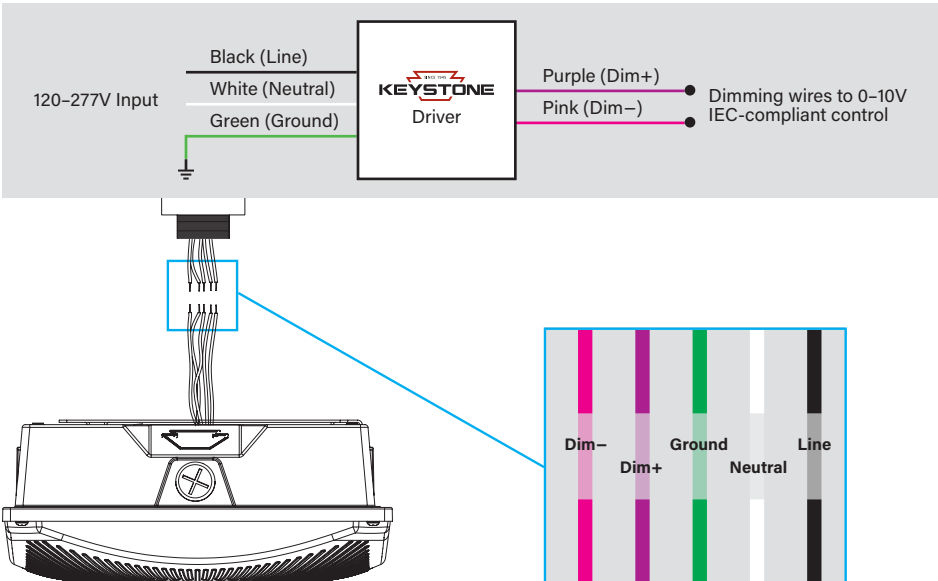

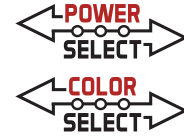

KT-CLEDXXPS-X1-8CSB-VDIM-X

LED SQUARE CANOPY LIGHT FIXTURE

POWER SELECT (WATTAGE) AND COLOR SELECT (CCT) ADJUSTMENT

This fixture is equipped with field-adjustable Keystone Power Select and Color Select technology.

1. Ensure power is off to the fixture.
2. Remove knockouts.
3. Adjust dip switches to desired settings.
4. Replace knockouts.
5. Restore power to fixture.

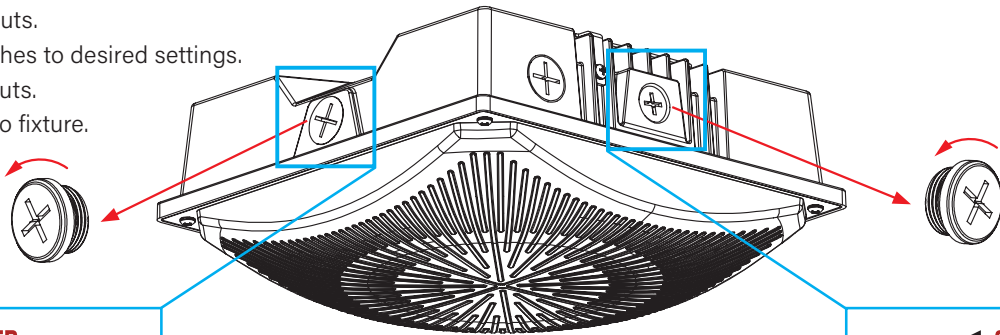

POWER SELECT ADJUSTMENT SWITCH
Set dip switch to adjust wattage. Fixture comes preset at highest wattage

PHOTOCELL ON/OFF SWITCH
Set dip switch to turn on or turn off built-in photocell.

COLOR SELECT ADJUSTMENT SWITCH
Set dip switch to adjust CCT between 3000K, 4000K, and 5000K. Fixture comes preset at 5000K.

KT-CLED60PS-M1-8CSB-VDIM
KT-CLED60PS-M1-8CSB-VDIM-W

Wattage	CCT
60W	3000K
50W	4000K
40W	5000K

KT-CLED40PS-S1-8CSB-VDIM
KT-CLED40PS-S1-8CSB-VDIM-W

Wattage	CCT
40W	3000K
30W	4000K
20W	5000K

KT-CLED25PS-S1-8CSB-VDIM

Wattage	CCT
25W	3000K
20W	4000K
15W	5000K

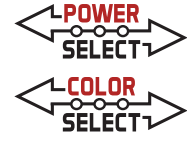

KT-CLEDXXPS-X1-8CSB-VDIM-X

LED SQUARE CANOPY LIGHT FIXTURE

DIMENSIONS

KT-CLED25PS-S1-8CSB-VDIM | KT-CLED40PS-S1-8CSB-VDIM | KT-CLED40PS-S1-8CSB-VDIM-W

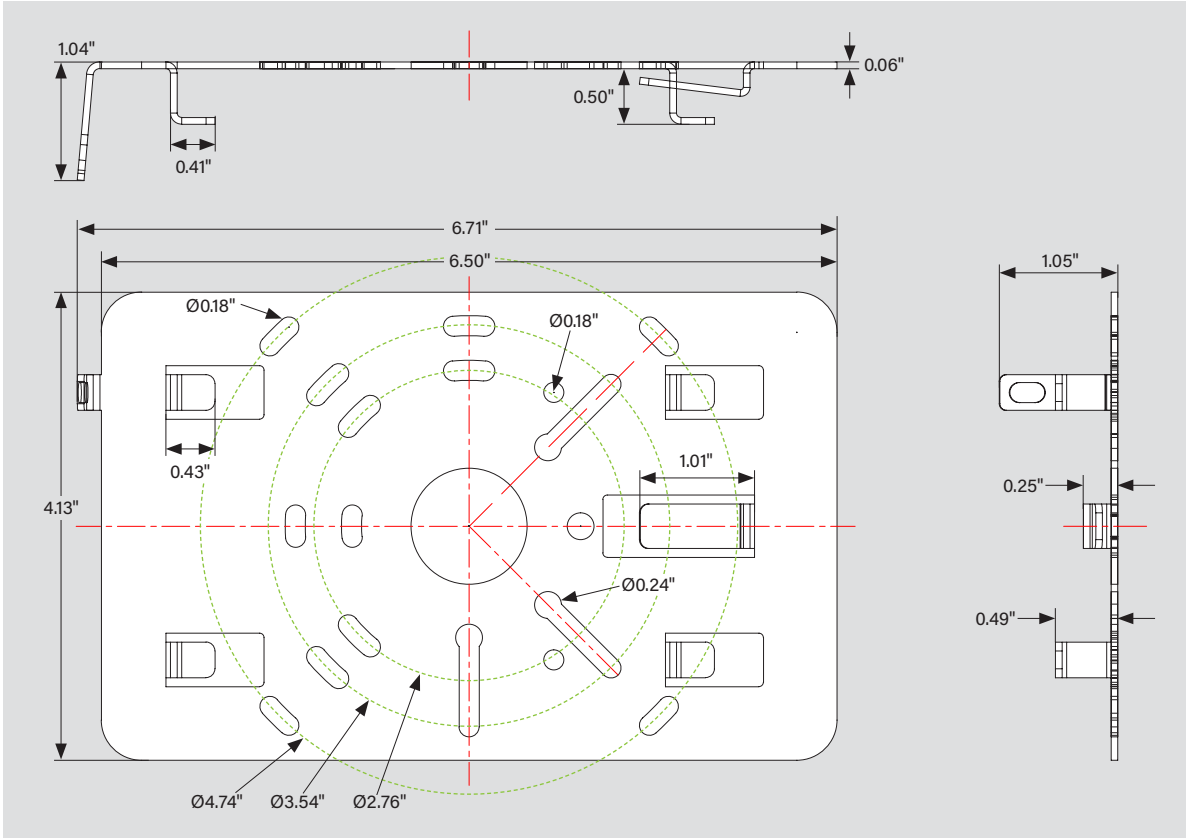
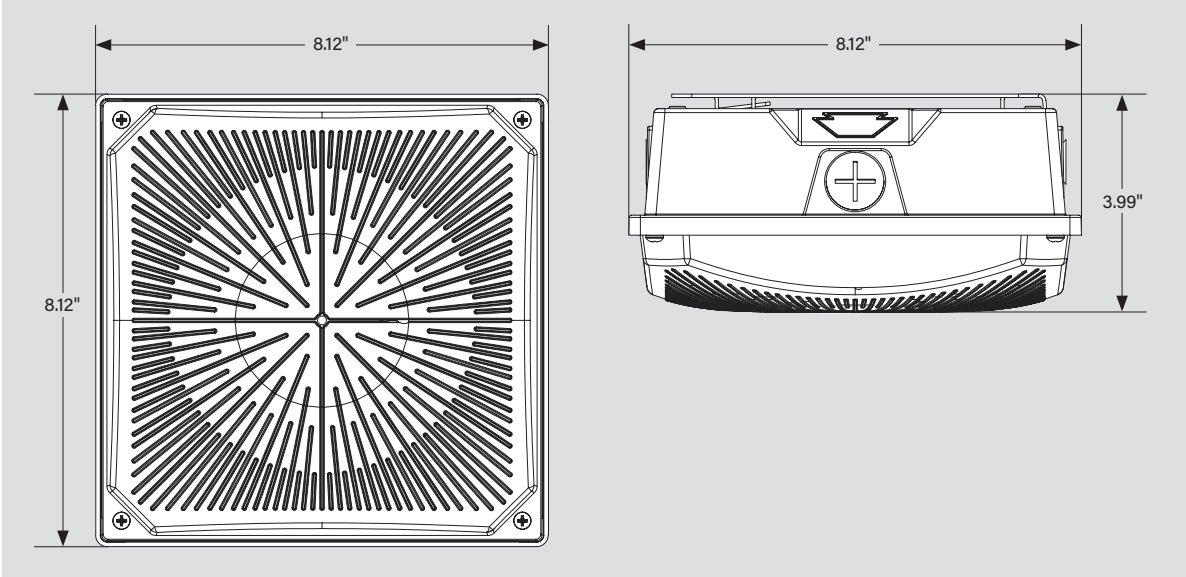

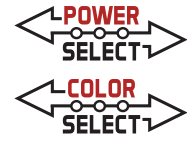

KT-CLEDXXPS-X1-8CSB-VDIM-X

LED SQUARE CANOPY LIGHT FIXTURE

DIMENSIONS (CONTINUED)

KT-CLED60PS-M1-8CSB-VDIM | KT-CLED60PS-M1-8CSB-VDIM-W

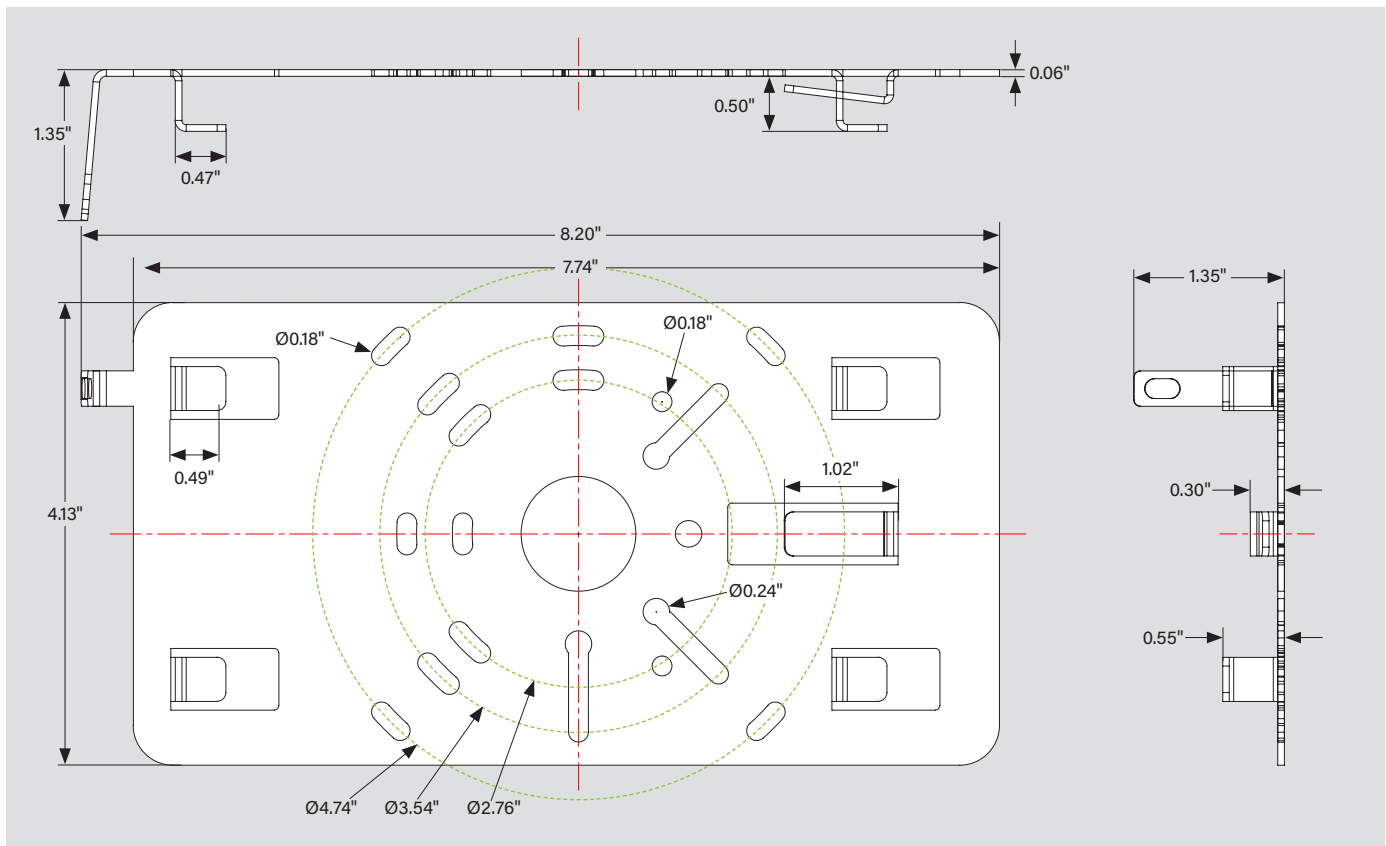
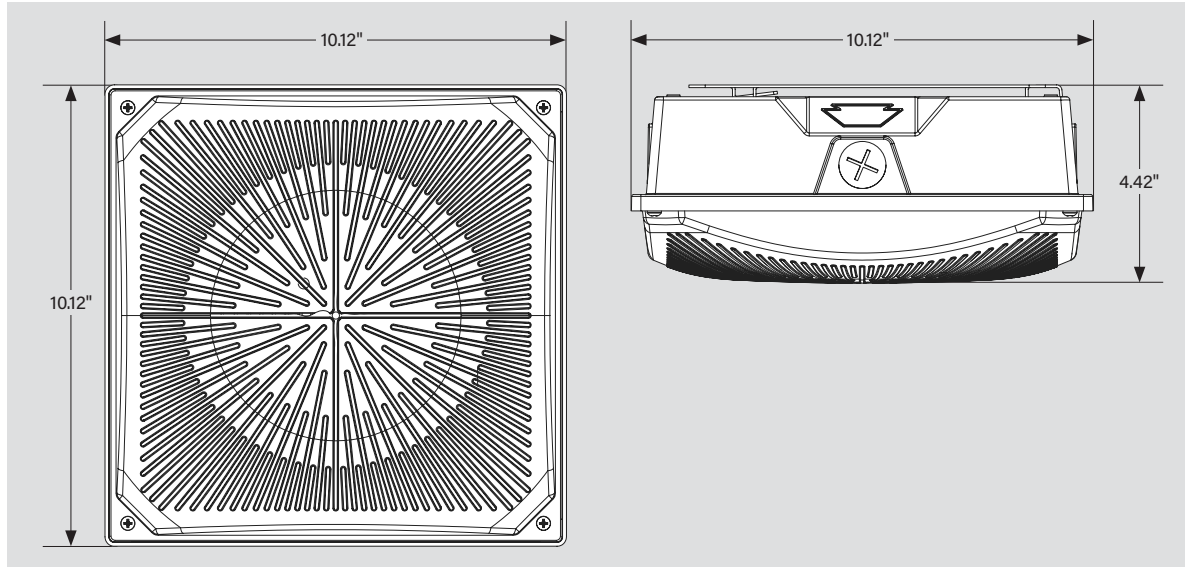

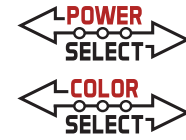

KT-CLEDXXPS-X1-8CSB-VDIM-X

LED SQUARE CANOPY LIGHT FIXTURE

ACCESSORIES

SENSORS / CONTROLLERS

Factory-Installable OR Field-Installable (field-installable purchased separately)

✓	SUFFIX	CATALOG NUMBER	DESCRIPTION	UPC	EASY CODE
	/FC4	KTSL-FC4-12V-PKO*	Bluetooth mesh wireless screw-in low voltage fixture controller for SmartLoop system 	843654149066	RUN-10
	/MW3	KTS-MW3-12V-PKO	12V Microwave Occupancy Sensor	843654135212	TRM-32



* KTSL-FC4-12V-PKO is not compatible with 25W and 40W square canopies

LENSES

Factory-Installable OR Field-Installable (field-installable purchased separately)

✓	SUFFIX*	CATALOG NUMBER	DESCRIPTION	UPC	EASY CODE
	/L110	KT-CLED-LENS-S1-110-KIT	110° beam angle lens Used on 8" square canopy	843654152011	GNA-34
	/L110	KT-CLED-LENS-M1-110-KIT	110° beam angle lens Used on 10" square canopy	843654152004	AHD-34



MOUNTS AND BRACKETS

Field-Installable / Field-Use ONLY (purchased separately)

CATALOG NUMBER	DESCRIPTION	COLOR	UPC	EASY CODE
KT-CLED-BP-15	15" mounting back plate Used on all canopy fixtures	Bronze	843654152028	FHA-85
KT-CLED-SM-1-KIT	Surface mount / pendant mount kit Attaches to pre-installed mounting plate	Bronze	843654160368	HRA-27
KT-CLED-TM-1-KIT	Trunnion mount kit Must be used with surface mount kit, KT-CLED-SM-1-KIT	Bronze	843654164090	ODY-40
KT-CLED-BP-15-W	15" mounting back plate	White	843654152035	CEU-41
KT-CLED-SM-1-KIT-W	Surface mount / pendant mount kit Attaches to pre-installed mounting plate	White	843654160375	ZDU-78
KT-CLED-TM-1-KIT-W	Trunnion mount kit Must be used with surface mount kit, KT-CLED-SM-1-KIT-W	White	843654164106	DPP-15



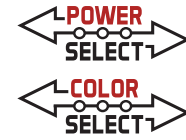

KT-CLEDXXPS-X1-8CSB-VDIM-X

LED SQUARE CANOPY LIGHT FIXTURE

ACCESSORIES (CONTINUED)

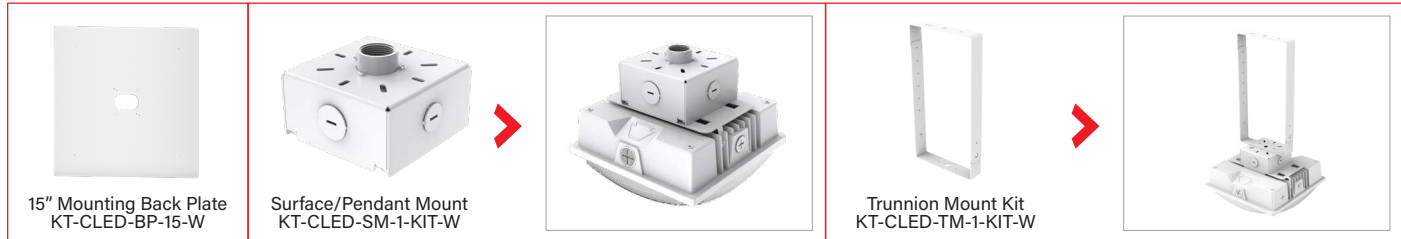

* For factory installation of accessory, add suffix to fixture part number (see ordering examples and instructions on last page of spec sheet).

FIXTURE ORDERING INFORMATION

ORDER CODE	UPC	Easy Code	DLC PRODUCT ID
KT-CLED25PS-S1-8CSB-VDIM	843654151984	WHH-10	S-TB32DJ
KT-CLED25PS-S1-8CSB-VDIM /L110	843654163116	XVG-21	S-SYZ8WV S-CR4UP8
KT-CLED40PS-S1-8CSB-VDIM	843654151960	YFZ-10	S-2I7S3O
KT-CLED40PS-S1-8CSB-VDIM-W	843654151977	AZF-82	
KT-CLED40PS-S1-8CSB-VDIM /L110	843654163123	AZK-33	S-7BTLCP S-ORPVJD
KT-CLED40PS-S1-8CSB-VDIM-W /L110	843654163130	NNO-93	
KT-CLED60PS-M1-8CSB-VDIM	843654151953	TDT-55	S-TU8M9J
KT-CLED60PS-M1-8CSB-VDIM-W	843654160146	XEC-85	
KT-CLED60PS-M1-8CSB-VDIM /L110	843654163154	ARQ-04	S-UO7Y3A S-0AXF86
KT-CLED60PS-M1-8CSB-VDIM-W /L110	843654163147	GEV-30	

FIXTURE CATALOG NUMBER BREAKDOWN

KT-CLEDXXPS-X1-8CSB-VDIM-X

1	2	3	4	5	6	7	8	9	10	11	12								
1 Keystone Technologies	2 Canopy Light Fixture	3 LED Technology	4 Max Wattage	5 Power Select	6 Size	7 Series 1	8 80 CRI	9 Color Select Technology	10 Color Select 3000/4000/5000K	11 0-10V Dimming	12 Housing Color								
										<table border="1"> <tr> <td>S</td> <td>Small</td> </tr> <tr> <td>M</td> <td>Medium</td> </tr> </table>	S	Small	M	Medium	<table border="1"> <tr> <td>W</td> <td>White</td> </tr> <tr> <td></td> <td>Bronze</td> </tr> </table>	W	White		Bronze
S	Small																		
M	Medium																		
W	White																		
	Bronze																		

ORDERING EXAMPLES

FIXTURE WITH MULTIPLE FACTORY-INSTALLED ACCESSORIES*
KT-CLED60PS-M1-8CSB-VDIM/FC4/L110

FIXTURE WITH SINGLE FACTORY-INSTALLED ACCESSORY
KT-CLED60PS-M1-8CSB-VDIM/FC4

FIXTURE WITH NO FACTORY-INSTALLED ACCESSORIES
KT-CLED60PS-M1-8CSB-VDIM

KEYSTONE FIXTURE	
CATALOG NUMBER	
KT-CLED25PS-S1-8CSB-VDIM	
SENSORS / CONTROLLERS	
<input checked="" type="checkbox"/> SUFFIX*	CATALOG NUMBER
<input checked="" type="checkbox"/> /FC4	KTSL-FC4-12V-PKO
<small>*KTSL-FC4-12V-PKO is not compatible with 25W and 40W square canopies</small>	
LENSES	
<input checked="" type="checkbox"/> SUFFIX	CATALOG NUMBER
<input checked="" type="checkbox"/> /L110	KT-CLED-LENS-S1-110-KIT

* When ordering more than one factory-installed accessory, use multiple suffixes as shown in the ordering examples above.
Note: All accessories can also be ordered separately for field installation using just their regular Catalog Number, UPC, or Easy Code.