

Advance Xtitanium edge industrial LED drivers are designed to meet basic lighting needs in highbay applications. These dimmable drivers are offered with specific current settings and are optimized for use with Advance Fortimo edge modules making LED conversion affordable.

### Specifications

Input Volt. (Vac)	Output Power (W)	Output Volt. (V)*	Output Current (A)	Efficiency@ Max. Load and 75°C Case	Max. Case Temp. (°C)	Input Current (A)	Max. Input Power (W)	THD @ Max. Load (%)	Power Factor @ Max. Load	Surge Protection (Combi-Wave, KV)	Envir. Protection Rating	Dim	Dimming Range (with specified dimmers)	Min. Output Current (A)	Other Notes	Driver Type
120	75	30-50 Class 2 Output	1.6	88.5%	Life 85°C UL 90°C	0.72	87	<10%	>0.9	>6KV	UL damp & dry and Type HL	0-10V Analog Class 1 and 2 Wiring	10% ~ 100%	0.16	Dimming source current: 150 µA	Constant Current
277				89.5%		0.32		<15%								

### Enclosure

	In. (mm)
Case Length (L2)	8.44 (214.3)
Case Width (W)	1.70 (43.1)
Case Height (H)	1.13 (28.8)
Mounting Length (M)	8.91 (226.3)
Mounting Hole Diameter (D)	0.31 (7.9)
Overall Length (L1)	9.45 (240.0)

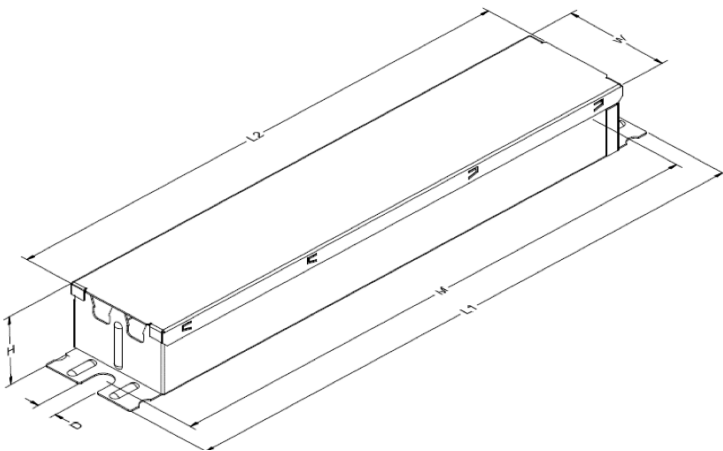

### Wiring Diagram

Dimming	Wire Length (mm)
Black (Line)	270 (± 30)
White (Neutral)	270 (± 30)
Red (Positive, LED Output)	270 (± 30)
Blue (Negative, LED output)	270 (± 30)
Violet (Positive, 0-10V)	270 (± 30)
Pink (Negative, 0-10V)	270 (± 30)

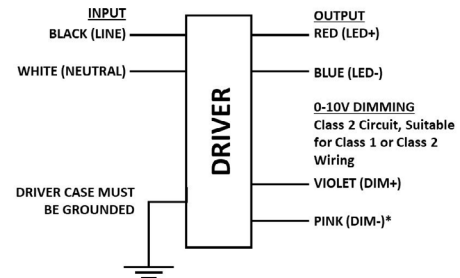

#### WARNING:

Install in accordance with national and local electrical codes. The field-wiring leads or push-in terminals shall be fully enclosed. Use 18 AWG solid copper wire. Rated  $\geq 90^\circ\text{C}$ . Strip wire 3/8".

#### GROUNDING:

Driver case must be grounded.

\* These systems are ideal for stock and flow luminaire lines.

# Xitanium edge XI075C160V050CNS2

75W 1.6A 50V 0-10V

## Features

- No programming necessary, fixed current, 0-10V dimming
- High efficiency – target 88.5%
- UL Class 2 rated. Class P listing (UL, CSA, ETL)
- Tc 90°C max specification
- 6kV/3kA surge rating – ANSI C82.77-5

## Benefits

- High reliability and performance specifications
- Class 2 output to simplify isolation requirements

## Application

- Linear high-bay luminaires

## Electrical Specifications

All the specifications are typical and at 25°C Tcase unless specified otherwise.

## Product Data

Order Information	
Full Product Code	XI075C160V050CNS2 (12NC= 929001759213M) 20 pieces in a Midpack
Line Frequency	50/60Hz
Min. Mains Voltage Operational	108 Vac
Max. Mains Voltage Operational	305 Vac
Output Information	
Maximum Open Circuit Voltage	<60Vdc (Class 2 output)
Output Current Ripple (in CC mode) (ripple = peak to average / average)	15% max. @ max. lout
Output Current Tolerance (at maximum output current)	<5%
Protections	Short Circuit and Open Circuit Protection for LED + and LED-, Overheat Protection
Features	
0-10V Dimming <sup>3</sup>	150µA (±3%) source current from driver. See dim curve for detail.
Environment & Approbation	
Operating Ambient Temp. Range	-40°C to +60°C
Max. Case Temperature (Tcase)	90°C
Agency Approbations	UL8750, NOM, cUL
Electromagnetic Compliance	FCC Title 47 Part 15 Class A
Audible Noise	<24dB Class A
Weight	1.32 Lbs / 0.6 kgs

1. Advance Xitanium LED drivers are manufactured to engineering standards correlating to a designed and average life expectancy of 50,000 hours of operation at maximum rated case temperature. Minimum 90% survivals based on MTTF modeling.

# Xitanium edge XI075C160V050CNS2

75W 1.6A 50V 0-10V

## Electrical Specifications

All the specifications are typical and at 25°C Tcase unless specified otherwise.

## 0-10V Dimming Curve

Dimming source current from the driver: 150µA (@ 0<Vdim<8V)

Minimum dim level: 10% (minimum 160mA)

Maximum output voltage on the dimming wires: 12V

Control Lead Leakage Current: 0.01mA, recommend max number of control circuits in parallel refer to Design-in Guide

## Approved Dimmer List

Manufacturer	Manufacturer Part Number
Lutron	Visit <a href="http://www.lutron.com/advance">www.lutron.com/advance</a> for a list of dimmers (Mark VII) that will work with this driver
Leviton	IllumaTech IP7 series
Philips	Sunrise - SR1200ZTUNV

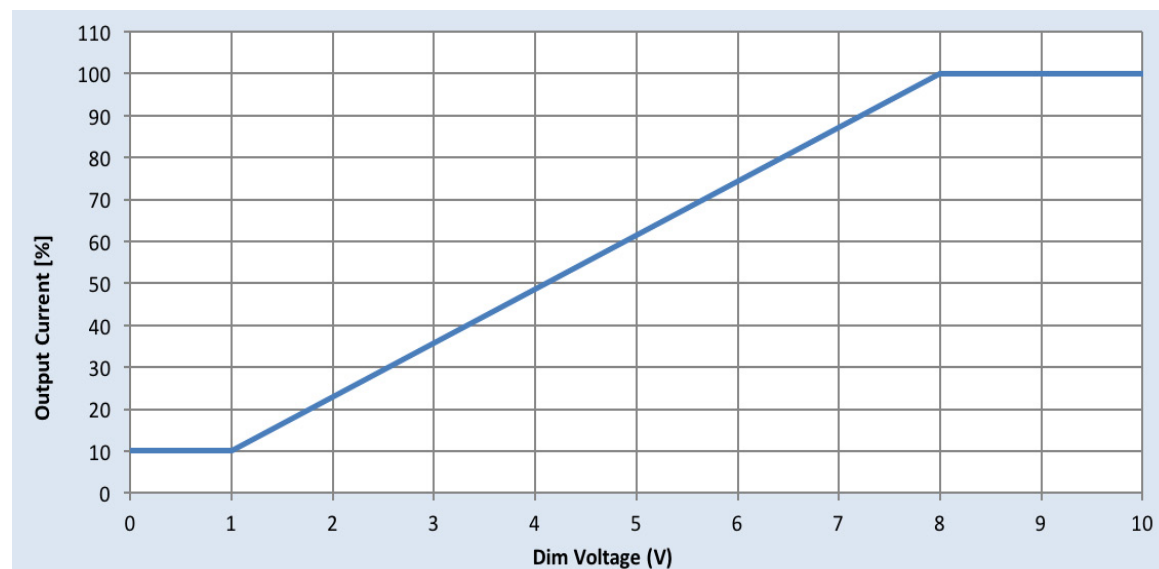

# Xitanium edge XI075C160V050CNS2

75W 1.6A 50V 0-10V

## Electrical Specifications

All the specifications are typical and at 25°C Tcase unless specified otherwise.

## Operating Window

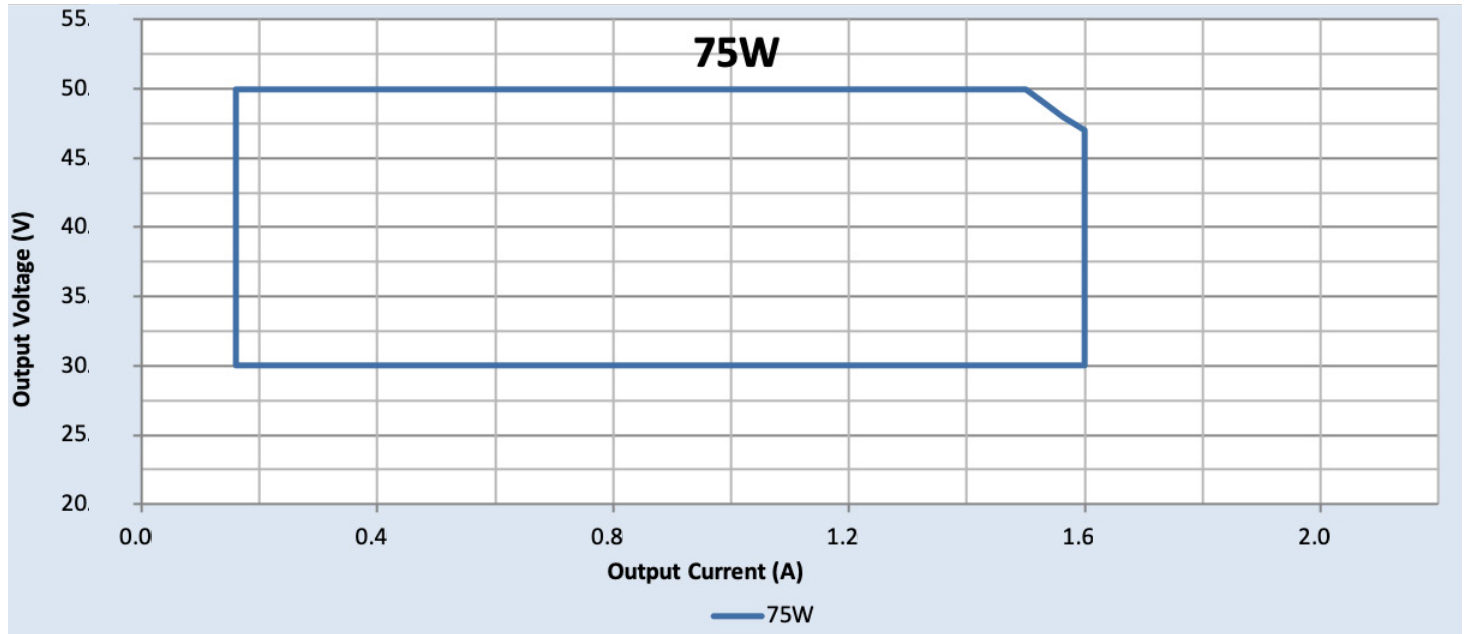

# Xitanium edge XI075C160V050CNS2

75W 1.6A 50V 0-10V

## Electrical Specifications

All the specifications are typical and at 25°C Tcase unless specified otherwise.

## Output Current Vs. Driver Case Temperature

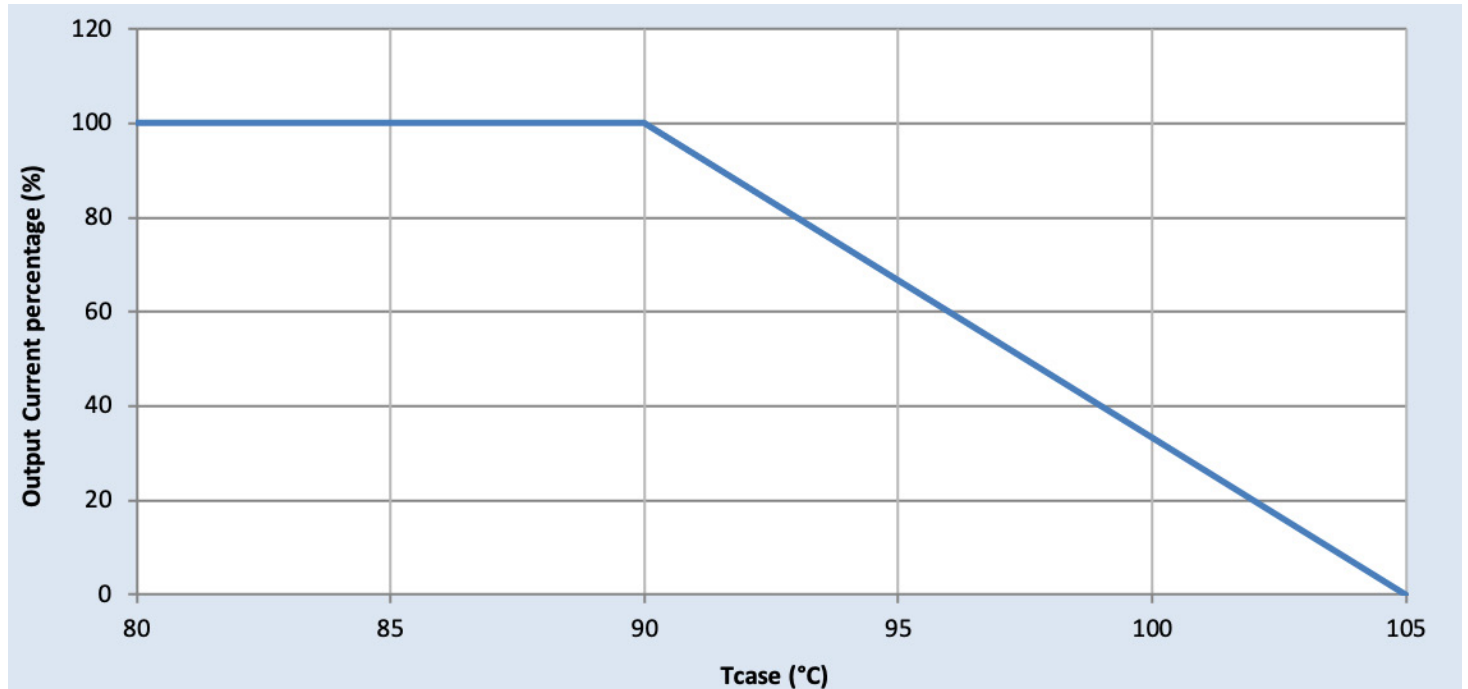

## Note

There is  $\pm 5^\circ\text{C}$  tolerance on the driver case temperature.

## Driver Lifetime Vs. Driver Case Temperature

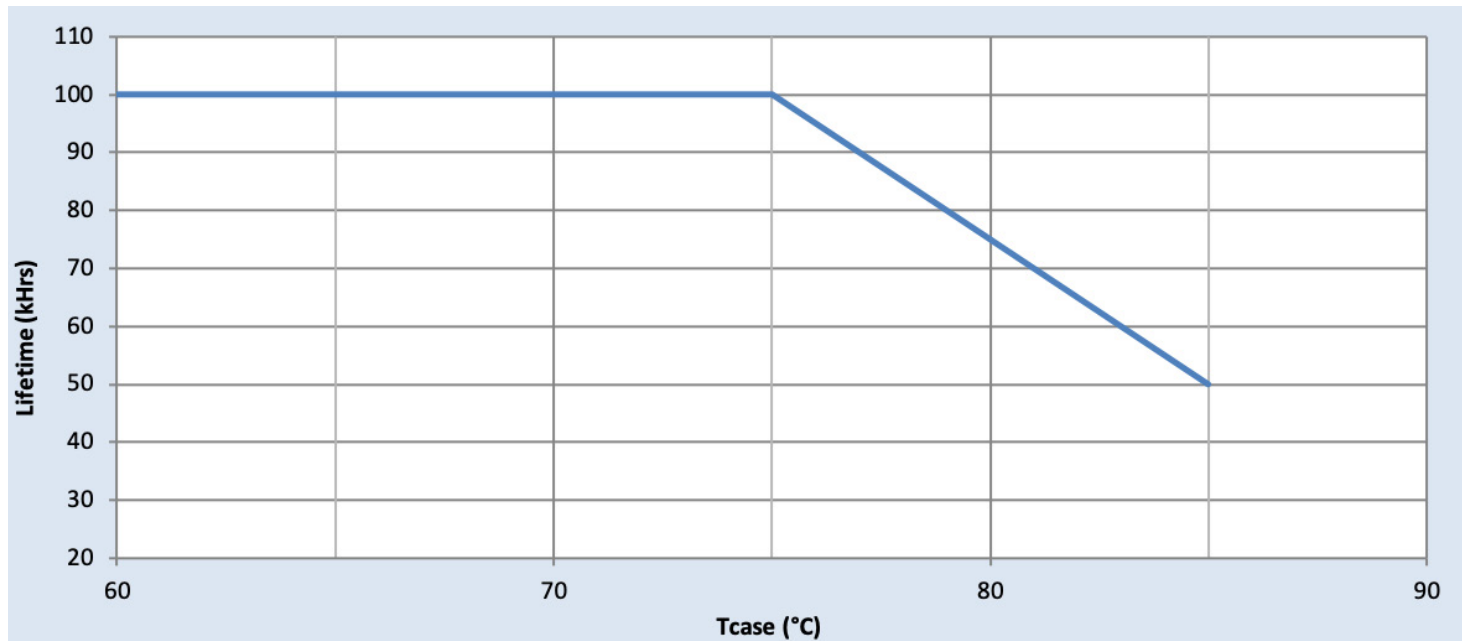

# Xitanium edge XI075C160V050CNS2

75W 1.6A 50V 0-10V

## Performance Characteristics

Based on measurements on a typical sample at 75°C case. The accuracy of the measurements is within the tolerance of the measurement instruments.

## Efficiency Vs. Output Voltage

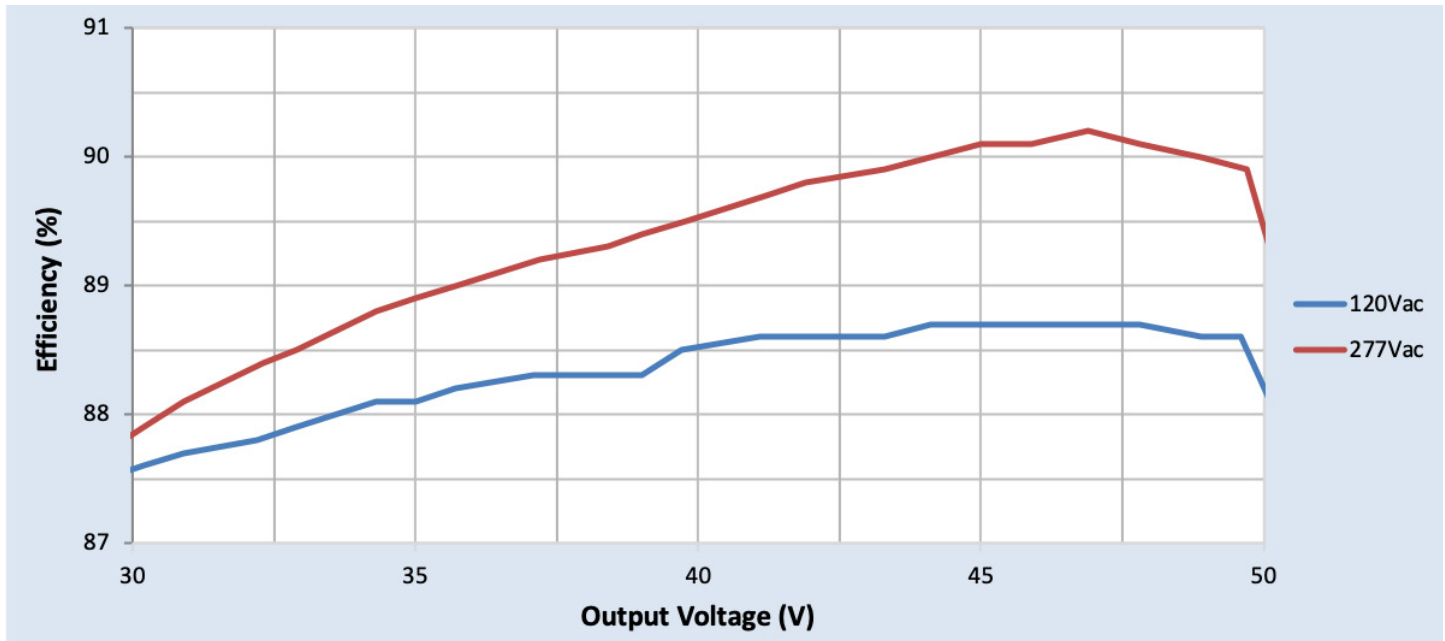

# Xitanium edge XI075C160V050CNS2

75W 1.6A 50V 0-10V

## Performance Characteristics

Based on measurements on a typical sample at 75°C case. The accuracy of the measurements is within the tolerance of the measurement instruments.

### Power Factor Vs. Output Power

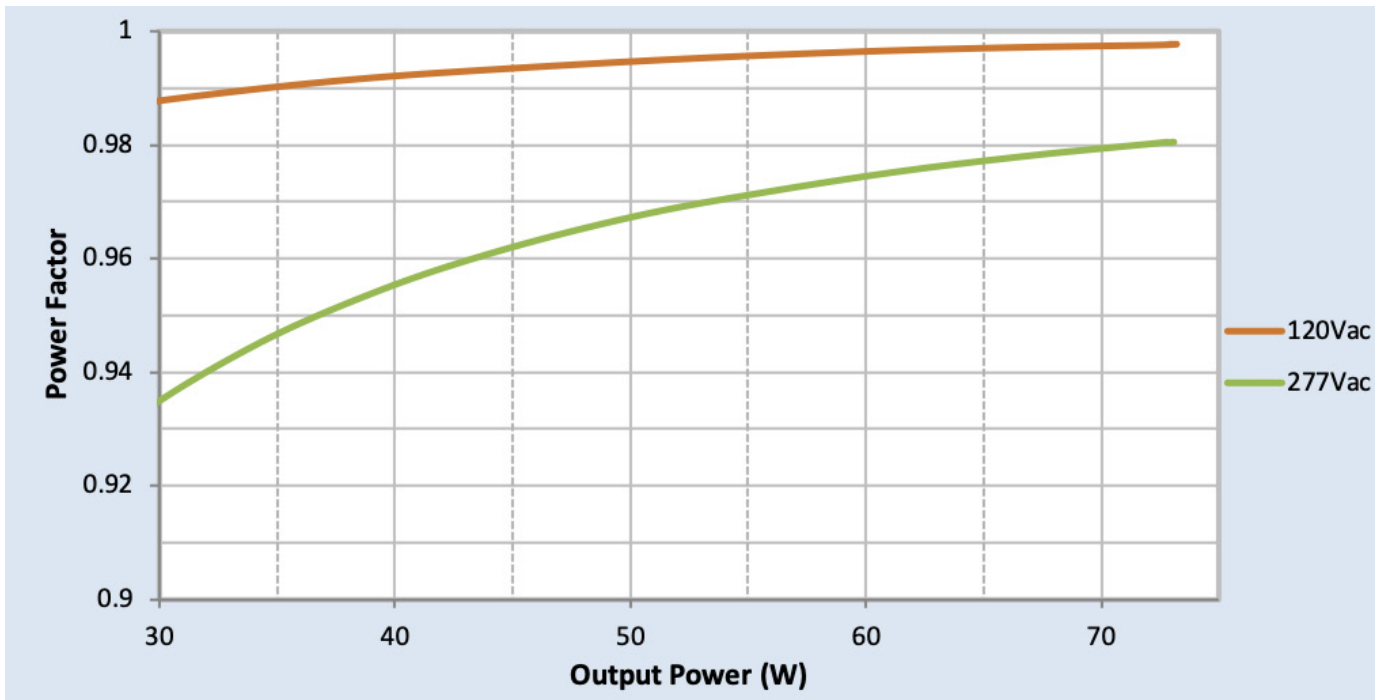

### Total Harmonic Distortion (THD) Vs. Output Power

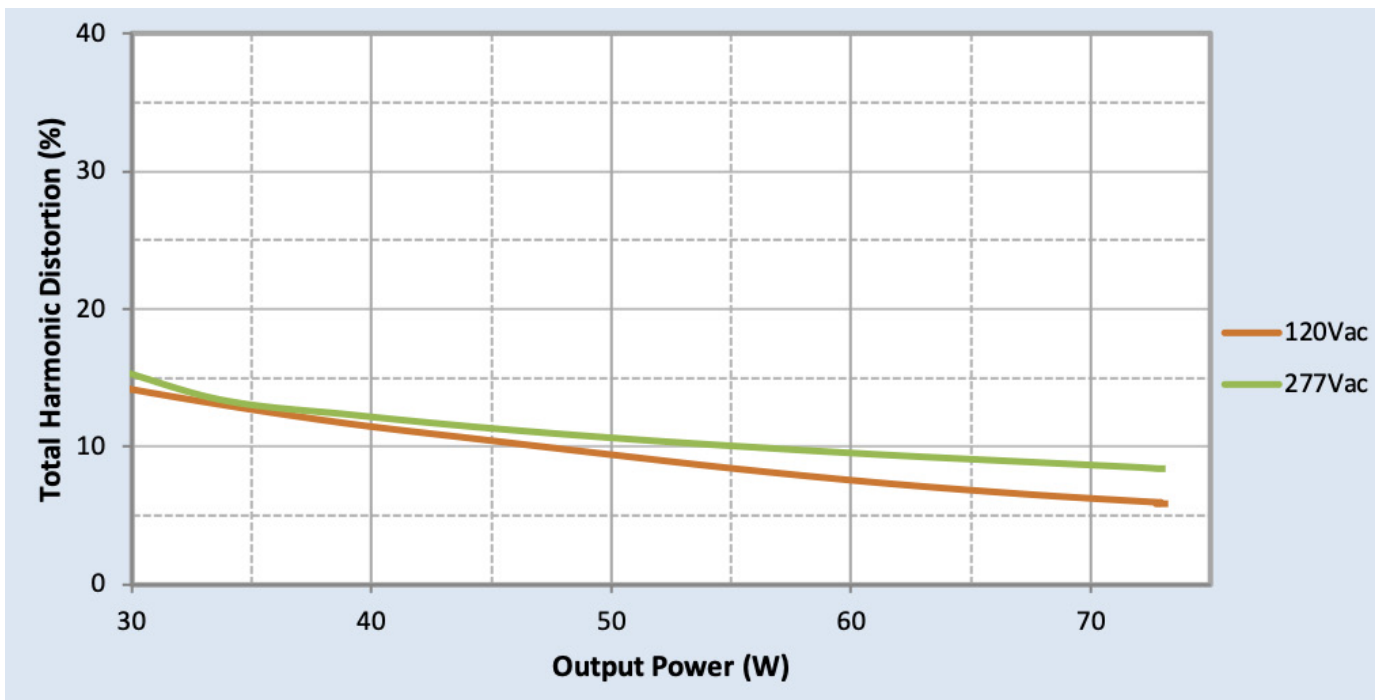

# Xitanium edge XI075C160V050CNS2

75W 1.6A 50V 0-10V

## Inrush Current Info

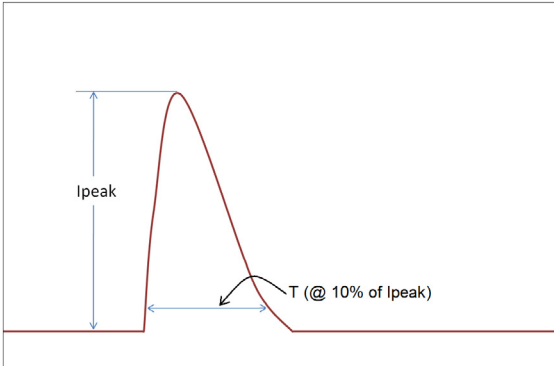

Vin	Ipeak	T (@ 10% of Ipeak)
120 Vrms	34.5A	184μS
277 Vrms	83.2A	179μS

Inrush current is measured at peak of the corresponding line voltage. Source impedance per NEMA 410.

## Lightning Surge Info

ANSI Surge Type	Differential Mode (L-N)	Common Mode (L-G, N-G, L&N-G)
1.2/50μs Combination Wave (w/t 2Ω)	6kV	6kV

## Isolation

Isolation	Input	Output	0-10V	Enclosure
Input	NA	2xU+1kV	2.5kV	2xU+1kV
Output	2xU+1kV	NA	2.5kV	2xU+1kV
0-10V (Class 2)	2.5kV	2.5kV	NA	2.5kV
Enclosure	2xU+1kV	2xU+1kV	2.5kV	NA

U=Max. Working Voltage

The information presented in this document is not intended as any commercial offer and does not form part of any quotation or contract.

