

Project Name:	Type:
Part Number:	Date:



GREENCREATIVE

REFINE PAR WITH SWAPPABLE LENS

FEATURES

- Suitable to replace 50W, 75W, 120W halogen lamps
- Patent pending Swappable Lens System design allows easy swapping of the lens in the field providing the most extensive range of PAR options.
- Powered by TRUE CHROMA: delivers best in class color accuracy and consistency
- Proprietary designed optic maximizes output, efficacy, color fidelity, and visual comfort
- High CRI and R values (R9 85, R13 95) deliver richer reds and healthier skin tones
- Smooth dimming with existing dimmers*
- Compact size 1:1 halogen form factor
- Spot, Narrow, Flood beam angles
- Available in 2700K, 3000K, 3500K, 4000K and 5000K color temperatures
- White and black finish color options
- Compliant with California Title 20 and Title 24 JA8 regulation requirements
- Suitable for damp locations and totally enclosed fixtures
- Fixture operating temperature: -4°F to 95°F (-20°C to 35°C)
- Lamp ambient temperature: -4°F to 113°F (-20°C to 45°C)
- Rated Lifetime (L70): 50,000hrs
- 5 year limited warranty**



031424



SPECIFICATIONS

Product	Model	Equiv.	Wattage (W)	Finish Color	CCT	Lumens	Efficacy (LPW)	Input Voltage	Beam Angle	CBCP (cd)	CRI	Dim.*	Base	Fixture Rating	TRUE CHROMA	ES / JA8 / T20	Single Product** / Kit***
37176	6.5PAR20DIM/927FL40/SL	50W	6.5	White	2700K	520	80	120V	40°	1,100	95	Yes	E26	Enclosed	Yes	✓/✓/✓	🔊
37177	6.5PAR20DIM/930FL40/SL	50W	6.5	White	3000K	550	85	120V	40°	1,200	95	Yes	E26	Enclosed	Yes	✓/✓/✓	🔊
37178	6.5PAR20DIM/930FL40/B/SL	50W	6.5	Black	3000K	550	85	120V	40°	1,200	95	Yes	E26	Enclosed	Yes	✓/✓/✓	🔊
37179	6.5PAR20DIM/935FL40/SL	50W	6.5	White	3500K	550	85	120V	40°	1,200	95	Yes	E26	Enclosed	Yes	✓/✓/✓	🔊
37180	6.5PAR20DIM/940FL40/SL	50W	6.5	White	4000K	580	89	120V	40°	1,300	95	Yes	E26	Enclosed	No	✓/✓/✓	🔊
37181	6.5PAR20DIM/950FL40/SL	50W	6.5	White	5000K	580	89	120V	40°	1,300	95	Yes	E26	Enclosed	No	✓/✓/✓	🔊
37182	6.5PAR20/927FL40/277V/SL	50W	6.5	White	2700K	520	80	120-277V	40°	1,100	95	No	E26	Enclosed	Yes	✓/✓/✓	🔊
37183	6.5PAR20/930FL40/277V/SL	50W	6.5	White	3000K	550	85	120-277V	40°	1,200	95	No	E26	Enclosed	Yes	✓/✓/✓	🔊
37184	6.5PAR20/940FL40/277V/SL	50W	6.5	White	4000K	580	89	120-277V	40°	1,300	95	No	E26	Enclosed	No	✓/✓/✓	🔊
37185	11PAR30DIM/927FL40/SL	75W	11	White	2700K	950	86	120V	40°	1,700	95	Yes	E26	Enclosed	Yes	✓/✓/✓	🔊
37186	11PAR30DIM/930FL40/SL	75W	11	White	3000K	990	90	120V	40°	1,750	95	Yes	E26	Enclosed	Yes	✓/✓/✓	🔊
37187	11PAR30DIM/930FL40/B/SL	75W	11	Black	3000K	990	90	120V	40°	1,750	95	Yes	E26	Enclosed	Yes	✓/✓/✓	🔊
37188	11PAR30DIM/935FL40/SL	75W	11	White	3500K	990	90	120V	40°	1,750	95	Yes	E26	Enclosed	Yes	✓/✓/✓	🔊
37189	11PAR30DIM/940FL40/SL	75W	11	White	4000K	1,030	94	120V	40°	1,850	95	Yes	E26	Enclosed	No	✓/✓/✓	🔊
37190	11PAR30DIM/950FL40/SL	75W	11	White	5000K	1,030	94	120V	40°	1,850	95	Yes	E26	Enclosed	No	✓/✓/✓	🔊
37191	11PAR30/927FL40/277V/SL	75W	11	White	2700K	950	86	120-277V	40°	1,700	95	No	E26	Enclosed	Yes	✓/✓/✓	🔊
37192	11PAR30/930FL40/277V/SL	75W	11	White	3000K	990	90	120-277V	40°	1,750	95	No	E26	Enclosed	Yes	✓/✓/✓	🔊
37193	11PAR30/940FL40/277V/SL	75W	11	White	4000K	1,030	94	120-277V	40°	1,850	95	No	E26	Enclosed	No	✓/✓/✓	🔊
37194	11PAR30SNDIM/927FL40/SL	75W	11	White	2700K	950	86	120V	40°	1,700	95	Yes	E26	Enclosed	Yes	✓/✓/✓	🔊
37195	11PAR30SNDIM/927FL40/B/SL	75W	11	Black	2700K	950	86	120V	40°	1,700	95	Yes	E26	Enclosed	Yes	✓/✓/✓	🔊
37196	11PAR30SNDIM/930NF25/SL	75W	11	White	3000K	990	90	120V	25°	4,700	95	Yes	E26	Enclosed	Yes	✓/✓/✓	🔊
37963	11PAR30SNDIM/930NF25/B/SL	75W	11	Black	3000K	990	90	120V	25°	4,700	95	Yes	E26	Enclosed	Yes	✓/✓/✓	🔊
37197	11PAR30SNDIM/930FL40/SL	75W	11	White	3000K	990	90	120V	40°	1,750	95	Yes	E26	Enclosed	Yes	✓/✓/✓	🔊
37198	11PAR30SNDIM/930FL40/B/SL	75W	11	Black	3000K	990	90	120V	40°	1,750	95	Yes	E26	Enclosed	Yes	✓/✓/✓	🔊
37199	11PAR30SNDIM/935FL40/SL	75W	11	White	3500K	990	90	120V	40°	1,750	95	Yes	E26	Enclosed	Yes	✓/✓/✓	🔊
37200	11PAR30SNDIM/940FL40/SL	75W	11	White	4000K	1,030	94	120V	40°	1,850	95	Yes	E26	Enclosed	No	✓/✓/✓	🔊
37201	11PAR30SNDIM/950FL40/SL	75W	11	White	5000K	1,030	94	120V	40°	1,850	95	Yes	E26	Enclosed	No	✓/✓/✓	🔊
37202	11PAR30SN/930FL40/277V/SL	75W	11	White	3000K	990	90	120-277V	40°	1,750	95	No	E26	Enclosed	Yes	✓/✓/✓	🔊
37203	15.5PAR38DIM/927FL40/SL	120W	15.5	White	2700K	1,320	85	120V	40°	2,800	95	Yes	E26	Enclosed	Yes	✓/✓/✓	🔊
37204	15.5PAR38DIM/930SP15/SL	120W	15.5	White	3000K	1,370	88	120V	15°	14,700	95	Yes	E26	Enclosed	Yes	✓/✓/✓	🔊
37205	15.5PAR38DIM/930NF25/SL	120W	15.5	White	3000K	1,370	88	120V	25°	7,000	95	Yes	E26	Enclosed	Yes	✓/✓/✓	🔊
37206	15.5PAR38DIM/930FL40/SL	120W	15.5	White	3000K	1,370	88	120V	40°	2,900	95	Yes	E26	Enclosed	Yes	✓/✓/✓	🔊
37207	15.5PAR38DIM/930FL40/B/SL	120W	15.5	Black	3000K	1,370	88	120V	40°	2,900	95	Yes	E26	Enclosed	Yes	✓/✓/✓	🔊
37208	15.5PAR38DIM/935FL40/SL	120W	15.5	White	3500K	1,370	88	120V	40°	2,900	95	Yes	E26	Enclosed	Yes	✓/✓/✓	🔊
37209	15.5PAR38DIM/940FL40/SL	120W	15.5	White	4000K	1,420	92	120V	40°	3,000	95	Yes	E26	Enclosed	No	✓/✓/✓	🔊
37210	15.5PAR38DIM/950FL40/SL	120W	15.5	White	5000K	1,420	92	120V	40°	3,000	95	Yes	E26	Enclosed	No	✓/✓/✓	🔊
37211	15.5PAR38/930FL40/277V/SL	120W	15.5	White	3000K	1,370	88	120-277V	40°	2,900	95	No	E26	Enclosed	Yes	✓/✓/✓	🔊



REFINE PAR WITH SWAPPABLE LENS

SPECIFICATIONS

Product	Model	Equiv.	Wattage (W)	Finish Color	CCT	Lumens	Efficacy (LPW)	Input Voltage	Beam Angle	CBCP (cd)	CRI	Dim.*	Base	Fixture Rating	TRUE CHROMA	ES / JA8 / T20	Single Product** / Kit***
37620	15.5PAR38/930FL40/277V/SL+SL15D	120W	15.5	White	3000K	1,370	88	120-277V	15°	14,700	95	No	E26	Enclosed	Yes	√/√/√	⚡ + ⊕
37621	15.5PAR38/930FL40/277V/SL+SL25D	120W	15.5	White	3000K	1,370	88	120-277V	25°	7,000	95	No	E26	Enclosed	Yes	√/√/√	⚡ + ⊕
37622	15.5PAR38/940FL40/277V/SL+SL15D	120W	15.5	White	4000K	1,420	92	120-277V	15°	14,800	95	No	E26	Enclosed	No	√/√/√	⚡ + ⊕
37623	15.5PAR38/940FL40/277V/SL+SL25D	120W	15.5	White	4000K	1,420	92	120-277V	25°	7,100	95	No	E26	Enclosed	No	√/√/√	⚡ + ⊕

SPECIFICATIONS - SWAPPABLE LENS

Product	Model	Size	Beam Angle
37213	PAR20/SL15D	PAR20	15°
37214	PAR20/SL25D	PAR20	25°
37215	PAR30/SL15D	PAR30	15°
37216	PAR30/SL25D	PAR30	25°
37217	PAR38/SL15D	PAR38	15°
37218	PAR38/SL25D	PAR38	25°

Note: Consult factory for availability of product models

*This lamp is available for dimming with 120V line voltage only and might not be compatible with all dimmers. Please visit www.greencreative.com for compatibility information.

**Please visit www.greencreative.com for Limited Warranty terms.

Item	Icon	Image	Lens Swapping Required	Method for Swapping Lenses in the Field
Single Product***			No	N.A.
Kit****			Yes, lens swapping is required in the field.	See below section for steps of changing lens in the field

Patent Pending Swappable Lens System Design - Allows For Field Changeable Light Beam Angles

<p>1. Turn the ring counterclockwise to unlock the ring above the lens</p>	<p>2. Pull out the ring to release the lens</p>	<p>3. Switch to a new lens and reposition the ring over the newly installed lens.</p>	<p>4. Turn the ring clockwise to lock the ring fixing the new lens</p>
--	---	---	--

DIMENSIONS & WEIGHT

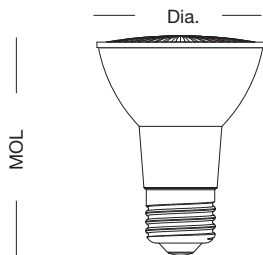

Model	MOL	Dia.	Weight
6.5PAR20DIM/xxxFL40/SL+SL15D	3-1/4"	2-1/2"	0.18lb
6.5PAR20DIM/xxxFL40/SL+SL25D			
6.5PAR20DIM/xxxFL40/SL			
6.5PAR20DIM/xxxFL40/B/SL+SL15D			
6.5PAR20DIM/xxxFL40/B/SL+SL25D			0.20lb
6.5PAR20DIM/xxxFL40/B/SL			
6.5PAR20/xxxFL40/277V/SL+SL15D			
6.5PAR20/xxxFL40/277V/SL+SL25D			
6.5PAR20/927FL40/277V/SL			



REFINE PAR WITH SWAPPABLE LENS

DIMENSIONS & WEIGHT

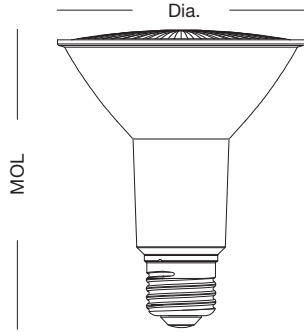

Model	MOL	Dia.	Weight
11PAR30DIM/xxxFL40/SL+SL15D	4-7/16"	3-11/16"	0.31lb
11PAR30DIM/xxxFL40/SL+SL25D			
11PAR30DIM/xxxFL40/SL			
11PAR30DIM/xxxFL40/B/SL+SL15D			
11PAR30DIM/xxxFL40/B/SL+SL25D			0.33lb
11PAR30DIM/xxxFL40/B/SL			
11PAR30/xxxFL40/277V/SL+SL15D			
11PAR30/xxxFL40/277V/SL+SL25D			
11PAR30/xxxFL40/277V/SL			

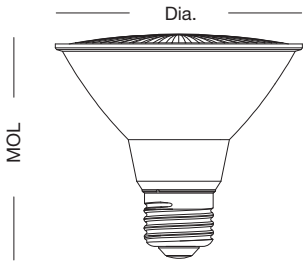

Model	MOL	Dia.	Weight
11PAR30NDIM/xxxFL40/SL+SL15D	3-5/16"	3-11/16"	0.30lb
11PAR30NDIM/xxxFL40/SL+SL25D			
11PAR30NDIM/xxxFL40/SL			
11PAR30NDIM/xxxFL40/B/SL+SL15D			
11PAR30NDIM/xxxFL40/B/SL+SL25D			0.32lb
11PAR30NDIM/xxxFL40/B/SL			
11PAR30SN/xxxFL40/277V/SL+SL15D			
11PAR30SN/xxxFL40/277V/SL+SL25D			
11PAR30SN/xxxFL40/277V/SL			

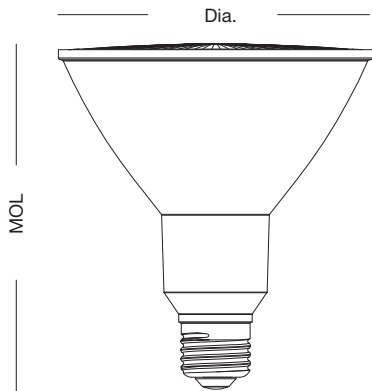

Model	MOL	Dia.	Weight
15.5PAR38DIM/xxxFL40/SL+SL15D	5-1/8"	4-5/8"	0.52lb
15.5PAR38DIM/xxxFL40/SL+SL25D			
15.5PAR38DIM/xxxFL40/SL			
15.5PAR38DIM/xxxFL40/B/SL+SL15D			
15.5PAR38DIM/xxxFL40/B/SL+SL25D			0.54lb
15.5PAR38DIM/xxxFL40/B/SL			
15.5PAR38/xxxFL40/277V/SL+SL15D			
15.5PAR38/xxxFL40/277V/SL+SL25D			
15.5PAR38/xxxFL40/277V/SL			

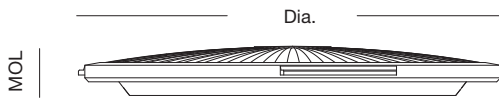

Model	MOL	Dia.	Weight
PAR20/SL15D	3/8"	2-7/16"	0.03lb
PAR20/SL25D		3-7/16"	0.07lb
PAR30/SL15D			
PAR30/SL25D	3/8"	3-7/16"	0.07lb
PAR38/SL15D			
PAR38/SL25D		4-1/2"	0.11lb

Where xxx means 824-965 which indicates CRI and color temperature

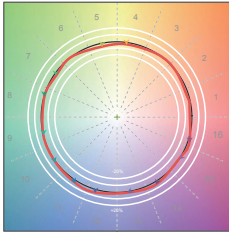
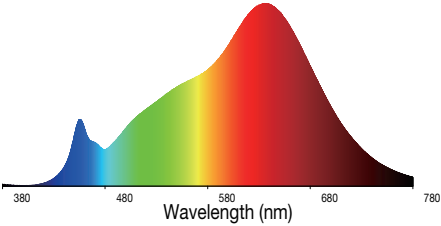
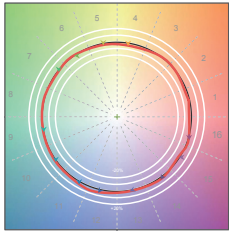
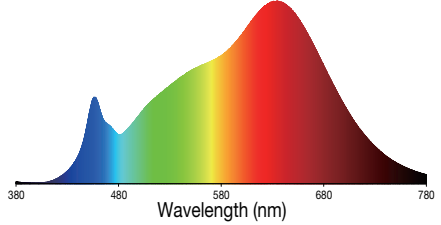
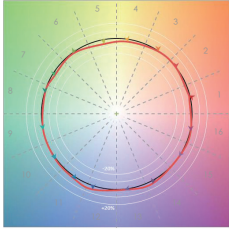
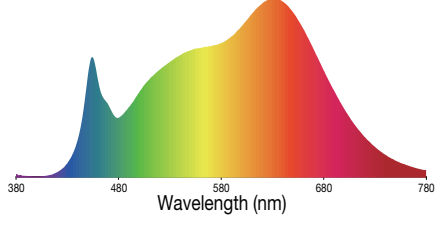
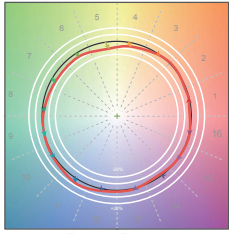
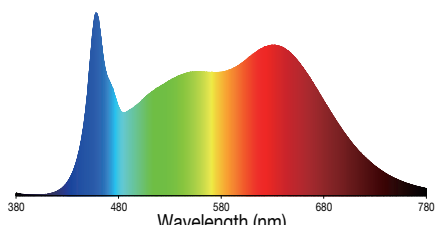
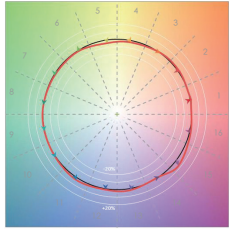
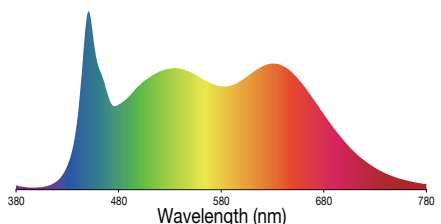

REFINE PAR WITH SWAPPABLE LENS

COLOR ACCURACY & SPECTRAL POWER DISTRIBUTION		
CCT	COLOR ACCURACY	SPECTRAL POWER DISTRIBUTION
2700K	 <p>Rr: 95, Rg: 100</p>	 <p>Wavelength (nm)</p>
3000K	 <p>Rr: 94, Rg: 99</p>	 <p>Wavelength (nm)</p>
3500K	 <p>Rr: 94, Rg: 99</p>	 <p>Wavelength (nm)</p>
4000K	 <p>Rr: 90, Rg: 97</p>	 <p>Wavelength (nm)</p>
5000K	 <p>Rr: 94, Rg: 101</p>	 <p>Wavelength (nm)</p>

Rf: TM-30 metric measuring color fidelity (whether colors are similar to those under natural light). Rf is a more accurate version of the CRI Ra. Rf is 100 for natural light.

Rg: TM-30 metric measuring color gamut (whether colors are more saturated than under natural light). Rg is 100 for natural light.



REFINE PAR WITH SWAPPABLE LENS

ILLUMINANCE & CANDELA DISTRIBUTION

6.5W PAR20 3000K 15°

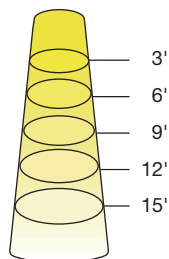

Diameter	Footcandles
0.8	589
1.6	147
2.4	65
3.2	37
3.9	24

6.5W PAR20 3000K 25°

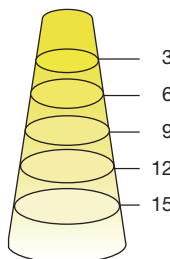

Diameter	Footcandles
1.3	211
2.7	53
4.0	23
5.3	13
6.7	8

6.5W PAR20 3000K 40°

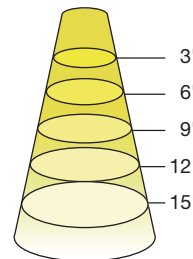

Diameter	Footcandles
2.2	133
4.4	33
6.6	15
8.7	8
10.9	5

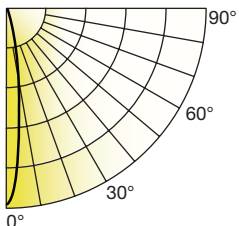

Degree	Candela
0	5300
5	3488
15	564
25	170
35	74
45	40

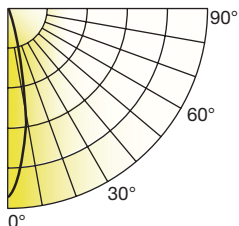

Degree	Candela
0	1900
5	1589
15	638
25	219
35	94
45	51

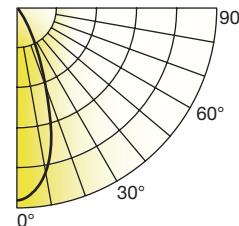

Degree	Candela
0	1200
5	1100
15	725
25	365
35	174
45	76

11W PAR30 3000K 15°

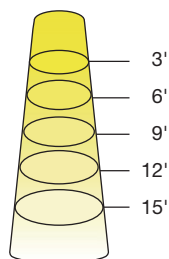

Diameter	Footcandles
0.8	1,178
1.6	294
2.4	131
3.2	74
3.9	47

11W PAR30 3000K 25°

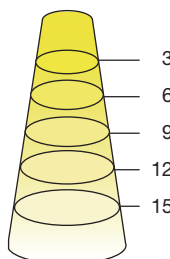

Diameter	Footcandles
1.3	522
2.7	131
4.0	58
5.3	33
6.7	21

11W PAR30 3000K 40°

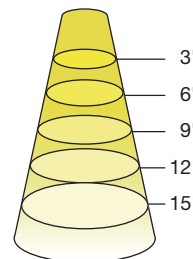

Diameter	Footcandles
2.2	194
4.4	49
6.6	22
8.7	12
10.9	8

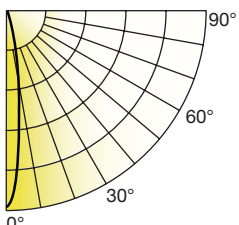

Degree	Candela
0	10,600
5	7,008
15	958
25	174
35	102
45	68

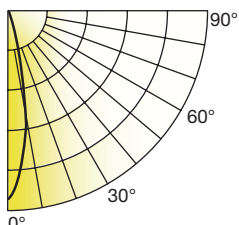

Degree	Candela
0	4,700
5	3,841
15	1,157
25	213
35	81
45	56

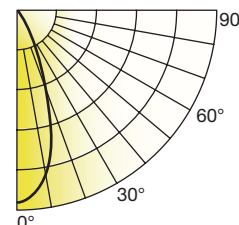

Degree	Candela
0	1,750
5	1,636
15	991
25	592
35	217
45	64



REFINE PAR WITH SWAPPABLE LENS

ILLUMINANCE & CANDELA DISTRIBUTION

11W PAR30SN 3000K 15°

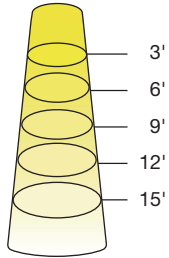

Diameter	Footcandles
3'	1,178
6'	294
9'	131
12'	74
15'	47

11W PAR30SN 3000K 25°

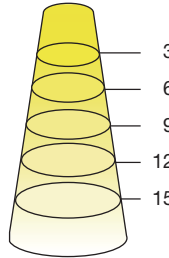

Diameter	Footcandles
3'	522
6'	131
9'	58
12'	33
15'	21

11W PAR30SN 3000K 40°

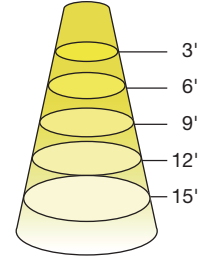

Diameter	Footcandles
3'	194
6'	49
9'	22
12'	12
15'	8

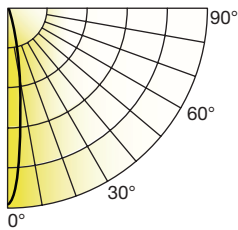

Degree	Candela
0	10,600
5	7,008
15	958
25	174
35	102
45	68

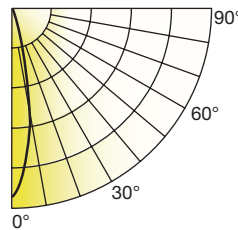

Degree	Candela
0	4,700
5	3,841
15	1,157
25	213
35	81
45	56

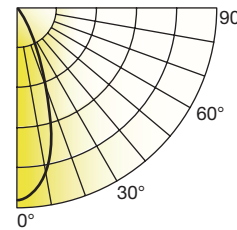

Degree	Candela
0	1,750
5	1,636
15	991
25	592
35	217
45	64

15.5W PAR38 3000K 15°

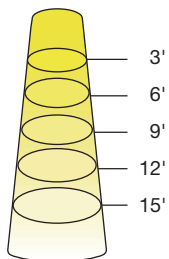

Diameter	Footcandles
3'	1,633
6'	408
9'	181
12'	102
15'	65

15.5W PAR38 3000K 25°

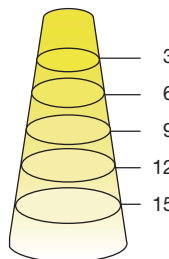

Diameter	Footcandles
3'	778
6'	194
9'	86
12'	49
15'	31

15.5W PAR38 3000K 40°

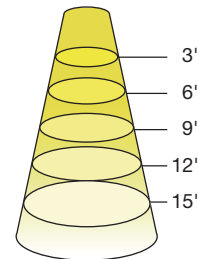

Diameter	Footcandles
3'	322
6'	81
9'	36
12'	20
15'	13

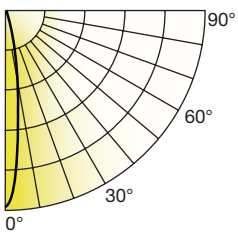

Degree	Candela
0	14,700
5	9,095
15	1,435
25	256
35	93
45	58

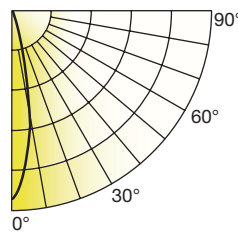

Degree	Candela
0	7,000
5	6,095
15	1,658
25	408
35	137
45	64

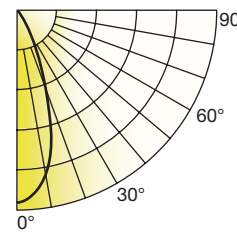

Degree	Candela
0	2,900
5	2,845
15	1,813
25	929
35	300
45	78

For other CCT use the following multiplier: 2700K .98, 3500K 1.00, 4000K 1.02, 5000K 1.02



REFINE PAR WITH SWAPPABLE LENS

ORDERING INFORMATION

Product Series	Master Carton			Shipping Carton		
	Case Qty	Case Dimensions (LxWxH)	Case Weight	Case Qty	Case Dimensions (LxWxH)	Case Weight
6.5PAR20DIM/xxxxyyy/SL	6PCS	8-3/8" x 5-13/16" x 4-1/16"	1.58 lb	24PCS	12-1/16" x 8-15/16" x 8-3/4"	7.05 lb
6.5PAR20DIM/xxxxyyy/B/SL	6PCS	8-3/8" x 5-13/16" x 4-1/16"	1.58 lb	24PCS	12-1/16" x 8-15/16" x 8-3/4"	7.05 lb
6.5PAR20/xxxxyyy/277V/SL	6PCS	8-3/8" x 5-13/16" x 4-1/16"	1.58 lb	24PCS	12-1/16" x 8-15/16" x 8-3/4"	7.05 lb
11PAR30DIM/xxxxyyy/SL	6PCS	11-13/16" x 8-1/16" x 5-1/8"	2.84 lb	24PCS	16-7/16" x 12-5/16" x 11-7/8"	12.67 lb
11PAR30DIM/xxxxyyy/B/SL	6PCS	11-13/16" x 8-1/16" x 5-1/8"	2.84 lb	24PCS	16-7/16" x 12-5/16" x 11-7/8"	12.67 lb
11PAR30/xxxxyyy/277V/SL	6PCS	11-13/16" x 8-1/16" x 5-1/8"	2.84 lb	24PCS	16-7/16" x 12-5/16" x 11-7/8"	12.67 lb
11PAR30SNDIM/xxxxyyy/SL	6PCS	11-13/16" x 8-1/16" x 4-5/16"	2.59 lb	24PCS	16-9/16" x 12-1/2" x 9-3/4"	11.57 lb
11PAR30SNDIM/xxxxyyy/B/SL	6PCS	11-13/16" x 8-1/16" x 4-5/16"	2.59 lb	24PCS	16-9/16" x 12-1/2" x 9-3/4"	11.57 lb
11PAR30SN/xxxxyyy/277V/SL	6PCS	11-13/16" x 8-1/16" x 4-5/16"	2.59 lb	24PCS	16-9/16" x 12-1/2" x 9-3/4"	11.57 lb
15.5PAR38DIM/xxxxyyy/SL	6PCS	15-3/8" x 10-1/2" x 6-1/4"	4.57 lb	24PCS	21-5/16" x 16-1/16" x 13-11/16"	19.73 lb
15.5PAR38DIM/xxxxyyy/B/SL	6PCS	15-3/8" x 10-1/2" x 6-1/4"	4.57 lb	24PCS	21-5/16" x 16-1/16" x 13-11/16"	19.73 lb
15.5PAR38/xxxxyyy/277V/SL	6PCS	15-3/8" x 10-1/2" x 6-1/4"	4.57 lb	24PCS	21-5/16" x 16-1/16" x 13-11/16"	19.73 lb
PAR20/SL15D	N.A	N.A	N.A	24PCS	5-5/16" x 4-7/16" x 3-1/16"	0.83 lb
PAR20/SL25D	N.A	N.A	N.A	24PCS	5-5/16" x 4-7/16" x 3-1/16"	0.83 lb
PAR30/SL15D	N.A	N.A	N.A	24PCS	7-5/16" x 4-7/8" x 4-1/8"	1.70 lb
PAR30/SL25D	N.A	N.A	N.A	24PCS	7-5/16" x 4-7/8" x 4-1/8"	1.70 lb
PAR38/SL15D	N.A	N.A	N.A	24PCS	9-3/8" x 4-3/4" x 5-1/16"	3.20 lb
PAR38/SL25D	N.A	N.A	N.A	24PCS	9-3/8" x 4-3/4" x 5-1/16"	3.20 lb

Where xxx means 824-965 which indicates CRI and color temperature

Where yyyy means beam angle

CERTIFICATION INFORMATION

Product	Model	ES ID	Product	Model	ES ID
37559	6.5PAR20DIM/927FL40/SL+SL15D	2853447	37574	6.5PAR20/930FL40/277V/SL+SL25D	2853263
37560	6.5PAR20DIM/927FL40/SL+SL25D	2853448	37183	6.5PAR20/930FL40/277V/SL	2853264
37176	6.5PAR20DIM/927FL40/SL	2853449	37575	6.5PAR20/940FL40/277V/SL+SL15D	2853265
37561	6.5PAR20DIM/930FL40/SL+SL15D	2853452	37576	6.5PAR20/940FL40/277V/SL+SL25D	2853266
37562	6.5PAR20DIM/930FL40/SL+SL25D	2853454	37184	6.5PAR20/940FL40/277V/SL	2853267
37177	6.5PAR20DIM/930FL40/SL	2853459	37577	11PAR30DIM/927FL40/SL+SL15D	2850665
37563	6.5PAR20DIM/930FL40/B/SL+SL15D	2853450	37578	11PAR30DIM/927FL40/SL+SL25D	2850666
37564	6.5PAR20DIM/930FL40/B/SL+SL25D	2853453	37185	11PAR30DIM/927FL40/SL	2850667
37178	6.5PAR20DIM/930FL40/B/SL	2853455	37579	11PAR30DIM/930FL40/SL+SL15D	2850669
37565	6.5PAR20DIM/935FL40/SL+SL15D	2853457	37580	11PAR30DIM/930FL40/SL+SL25D	2850671
37566	6.5PAR20DIM/935FL40/SL+SL25D	2853458	37186	11PAR30DIM/930FL40/SL	2850673
37179	6.5PAR20DIM/935FL40/SL	2853459	37581	11PAR30DIM/930FL40/B/SL+SL15D	2850668
37567	6.5PAR20DIM/940FL40/SL+SL15D	2853460	37582	11PAR30DIM/930FL40/B/SL+SL25D	2850670
37568	6.5PAR20DIM/940FL40/SL+SL25D	2853462	37187	11PAR30DIM/930FL40/B/SL	2850672
37180	6.5PAR20DIM/940FL40/SL	2853463	37583	11PAR30DIM/935FL40/SL+SL15D	3354746
37569	6.5PAR20DIM/950FL40/SL+SL15D	2853464	37584	11PAR30DIM/935FL40/SL+SL25D	2851674
37570	6.5PAR20DIM/950FL40/SL+SL25D	2853465	37188	11PAR30DIM/935FL40/SL	2851675
37181	6.5PAR20DIM/950FL40/SL	2853466	37585	11PAR30DIM/940FL40/SL+SL15D	2851676
37571	6.5PAR20/927FL40/277V/SL+SL15D	2852682	37586	11PAR30DIM/940FL40/SL+SL25D	2851677
37572	6.5PAR20/927FL40/277V/SL+SL25D	2852683	37189	11PAR30DIM/940FL40/SL	2852678
37182	6.5PAR20/927FL40/277V/SL	2853261	37587	11PAR30DIM/950FL40/SL+SL15D	2852679
37573	6.5PAR20/930FL40/277V/SL+SL15D	2853262	37588	11PAR30DIM/950FL40/SL+SL25D	2852680



REFINE PAR WITH SWAPPABLE LENS

CERTIFICATION INFORMATION

Product	Model	ES ID	Product	Model	ES ID
37190	11PAR30DIM/950FL40/SL	2852681	37607	11PAR30SNDIM/950FL40/SL+SL25D	2856262
37589	11PAR30/927FL40/277V/SL+SL15D	2856234	37201	11PAR30SNDIM/950FL40/SL	2856263
37590	11PAR30/927FL40/277V/SL+SL25D	2856235	37608	11PAR30SN/930FL40/277V/SL+SL15D	2861587
37191	11PAR30/927FL40/277V/SL	2856236	37609	11PAR30SN/930FL40/277V/SL+SL25D	2861976
37591	11PAR30/930FL40/277V/SL+SL15D	2856237	37202	11PAR30SN/930FL40/277V/SL	2861977
37592	11PAR30/930FL40/277V/SL+SL25D	2856238	37610	15.5PAR38DIM/927FL40/SL+SL15D	2860573
37192	11PAR30/930FL40/277V/SL	2856239	37611	15.5PAR38DIM/927FL40/SL+SL25D	2860574
37593	11PAR30/940FL40/277V/SL+SL15D	2856240	37203	15.5PAR38DIM/927FL40/SL	2860575
37594	11PAR30/940FL40/277V/SL+SL25D	2856241	37204	15.5PAR38DIM/930SP15/SL	2860577
37193	11PAR30/940FL40/277V/SL	2856242	37205	15.5PAR38DIM/930NF25/SL	2861238
37595	11PAR30SNDIM/927FL40/SL+SL15D	2856244	37206	15.5PAR38DIM/930FL40/SL	2861240
37596	11PAR30SNDIM/927FL40/SL+SL25D	2856246	37612	15.5PAR38DIM/930FL40/B/SL+SL15D	2860576
37194	11PAR30SNDIM/927FL40/SL	2856248	37613	15.5PAR38DIM/930FL40/B/SL+SL25D	2860578
37597	11PAR30SNDIM/927FL40/B/SL+SL15D	2856243	37207	15.5PAR38DIM/930FL40/B/SL	2861239
37598	11PAR30SNDIM/927FL40/B/SL+SL25D	2856245	37614	15.5PAR38DIM/935FL40/SL+SL15D	2861241
37195	11PAR30SNDIM/927FL40/B/SL	2856247	37615	15.5PAR38DIM/935FL40/SL+SL25D	2861242
37599	11PAR30SNDIM/930FL40/SL+SL15D	2856250	37208	15.5PAR38DIM/935FL40/SL	2861243
37196	11PAR30SNDIM/930NF25/SL	2856252	37616	15.5PAR38DIM/940FL40/SL+SL15D	2861244
37197	11PAR30SNDIM/930FL40/SL	2856254	37617	15.5PAR38DIM/940FL40/SL+SL25D	2861245
37600	11PAR30SNDIM/930FL40/B/SL+SL15D	2856249	37209	15.5PAR38DIM/940FL40/SL	2861246
37601	11PAR30SNDIM/930FL40/B/SL+SL25D	2856251	37618	15.5PAR38DIM/950FL40/SL+SL15D	2861247
37198	11PAR30SNDIM/930FL40/B/SL	2856253	37619	15.5PAR38DIM/950FL40/SL+SL25D	2861585
37602	11PAR30SNDIM/935FL40/SL+SL15D	2856255	37210	15.5PAR38DIM/950FL40/SL	2861586
37603	11PAR30SNDIM/935FL40/SL+SL25D	2856256	37620	15.5PAR38/930FL40/277V/SL+SL15D	3354770
37199	11PAR30SNDIM/935FL40/SL	2856257	37621	15.5PAR38/930FL40/277V/SL+SL25D	3354771
37604	11PAR30SNDIM/940FL40/SL+SL15D	2856258	37211	15.5PAR38/930FL40/277V/SL	3354772
37605	11PAR30SNDIM/940FL40/SL+SL25D	2856259	37622	15.5PAR38/940FL40/277V/SL+SL15D	3354773
37200	11PAR30SNDIM/940FL40/SL	2856260	37623	15.5PAR38/940FL40/277V/SL+SL25D	3354774
37606	11PAR30SNDIM/950FL40/SL+SL15D	2856261	37212	15.5PAR38/940FL40/277V/SL	3354775

Note: All rights reserved. All sizes and specifications are subject to change at any time without notice.