

## Features

- Ultra High Efficiency (Up to 93.5%)
- Full Power at Wide Output Current Range (Constant Power)
- Isolated 0-10V/10V PWM Dimmable (DT models)  
3-Timer-Modes Dimmable (TT models)
- Input Surge Protection: DM 6kV, CM 10kV
- All-Around Protection: OVP, SCP, OTP
- IP67 and UL Dry / Damp / Wet Location
- SELV Output
- TYPE HL, for use in a Class I, Division 2 hazardous (Classified) location
- 5 Years Warranty



## Description

The EUK-320SxxxDT(TT) series is a 320W, constant-current, programmable IP67 LED driver that operates from 90-305 Vac input with excellent power factor. It is created for many lighting applications including high bay, high mast, aquaculture and sport, etc. The high efficiency of these drivers and compact metal case enables them to run cooler, significantly improving reliability and extending product life. To ensure trouble-free operation, protection is provided against input surge, output over voltage, short circuit, and over temperature.

## Models

Adjustable Output Current Range	Full-Power Current Range (1)	Default Output Current	Input Voltage Range(2)	Output Voltage Range	Max. Output Power	Typical Efficiency (3)	Power Factor		Model Number (5)
							120Vac	220Vac	
105-1500mA	1050-1500mA	1400 mA	90~305 Vac/ 127~300 Vdc	107~305Vdc	320 W	93.5%	0.99	0.96	EUK-320S150DT(TT)
154-2200mA	1540-2200mA	2100 mA	90~305 Vac/ 127~300 Vdc	73~208Vdc	320 W	93.5%	0.99	0.96	EUK-320S220DT(TT)
224-3200mA	2240-3200mA	2800 mA	90~305 Vac/ 127~300 Vdc	50~143Vdc	320 W	92.5%	0.99	0.96	EUK-320S320DT(TT)
322-4600mA	3220-4600mA	4200 mA	90~305 Vac/ 127~300 Vdc	35~100Vdc	320 W	92.5%	0.99	0.96	EUK-320S460DT(TT) <sup>(4)</sup>
469-6700mA	4690-6700mA	6700 mA	90~305 Vac/ 127~300 Vdc	24 ~ 68Vdc	320 W	92.5%	0.99	0.96	EUK-320S670DT(TT) <sup>(4)</sup>

**Notes:** (1) Output current range with constant power at 320W.

(2) Certified input voltage range: UL, FCC 100-277Vac or 127-300Vdc; otherwise: 100-240Vac or 127-250Vdc.

(3) Measured at 100% load and 220Vac input (see below "General Specifications" for details).

(4) SELV output.

(5) All the models are certificated to KCC, except EUK-320SxxxTT.

## I-V Operating Area

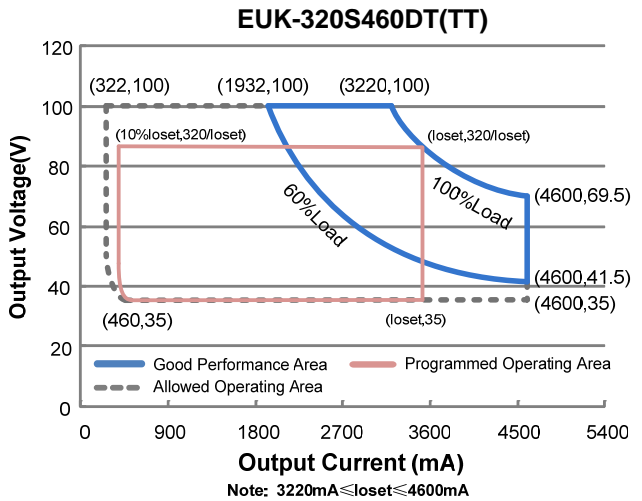
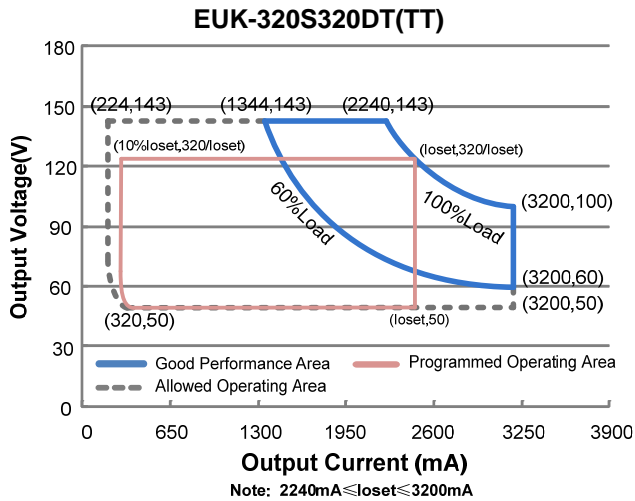
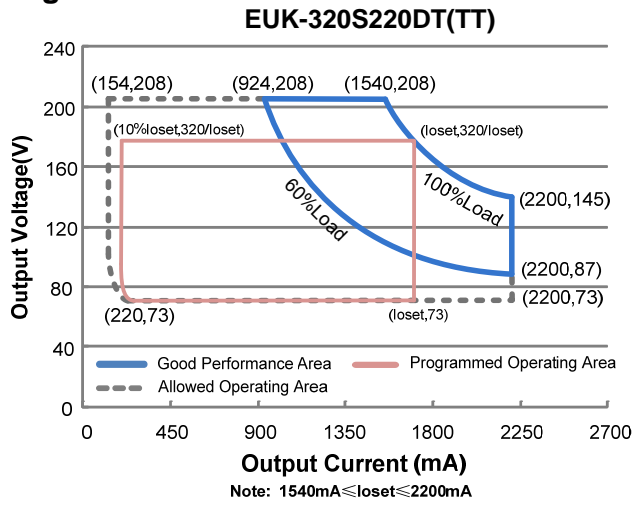
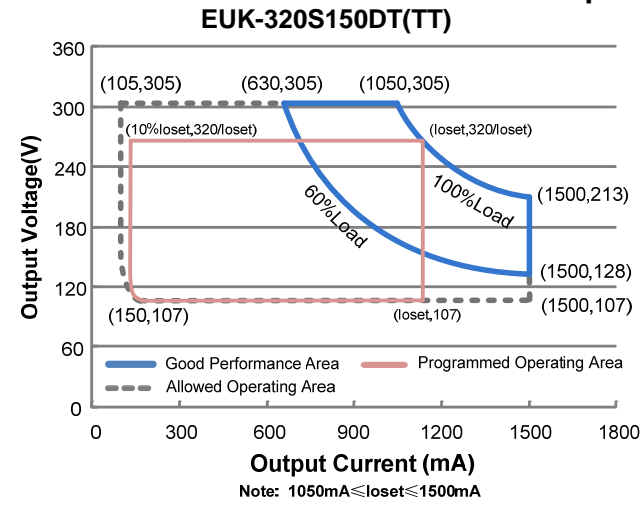

### EUK-320S670DT(TT)

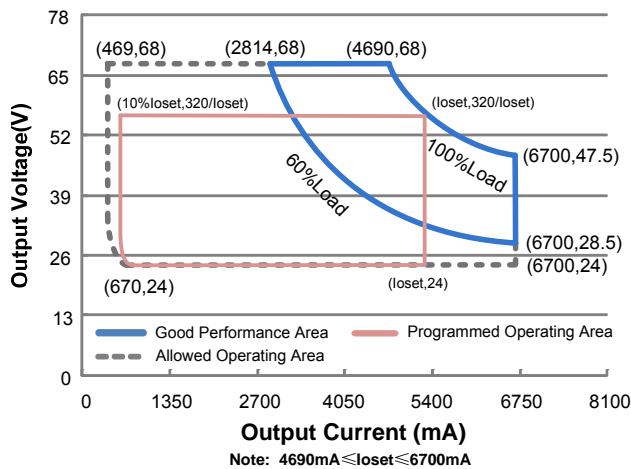

## Input Specifications

Parameter	Min.	Typ.	Max.	Notes
Input Voltage	90 Vac	-	305 Vac	127~300 Vdc
Input Frequency	47 Hz	-	63 Hz	
Leakage Current	-	-	0.75 MIU	UL8750; 277Vac/ 60Hz
	-	-	0.70 mA	IEC60598-1; 240Vac/ 60Hz,
Input AC Current	-	-	3.20 A	Measured at 100% load and 120 Vac input.
	-	-	1.70 A	Measured at 100% load and 220 Vac input.
Inrush Current(I <sup>2</sup> t)	-	-	1.30 A <sup>2</sup> s	At 220Vac input, 25°C cold start, duration=3.92 ms, 10%Ipk-10%Ipk. See Inrush Current Waveform for the details.
PF	0.9	-	-	At 100-277Vac, 50-60Hz, 60%-100%Load (192-320W)
THD	-	-	20%	
THD	-	-	10%	At 220-240Vac, 50-60Hz, 75%-100% Load (240-320W)

## Output Specifications

Parameter	Min.	Typ.	Max.	Notes
Output Current Tolerance	-5%loset	-	5%loset	At 100% load condition
Output Current Setting(loset) Range				
EUK-320S150DT(TT)	105 mA	-	1500 mA	
EUK-320S220DT(TT)	154 mA	-	2200 mA	
EUK-320S320DT(TT)	224 mA	-	3200 mA	
EUK-320S460DT(TT)	322 mA	-	4600 mA	
EUK-320S670DT(TT)	469 mA	-	6700 mA	
Output Current Setting Range with Constant Power				
EUK-320S150DT(TT)	1050 mA	-	1500 mA	
EUK-320S220DT(TT)	1540 mA	-	2200 mA	
EUK-320S320DT(TT)	2240 mA	-	3200 mA	
EUK-320S460DT(TT)	3220 mA	-	4600 mA	
EUK-320S670DT(TT)	4690 mA	-	6700 mA	
Total Output Current Ripple (pk-pk)	-	5%Iomax	10%Iomax	At 100% load condition. 20 MHz BW
Output Current Ripple at < 200 Hz (pk-pk)	-	2%Iomax	-	At 100% load condition. Only this component of ripple is associated with visible flicker.
Startup Overshoot Current	-	-	10%Iomax	At 100% load condition
No Load Output Voltage				
EUK-320S150DT(TT)	-	-	350 V	
EUK-320S220DT(TT)	-	-	250 V	
EUK-320S320DT(TT)	-	-	170 V	
EUK-320S460DT(TT)	-	-	120 V	
EUK-320S670DT(TT)	-	-	85 V	
Line Regulation	-	-	±0.5%	Measured at 100% load
Load Regulation	-	-	±1.5%	

## Output Specifications (Continued)

Parameter	Min.	Typ.	Max.	Notes
Turn-on Delay Time	-	-	1.0 s	Measured at 120Vac input, 60%-100% Load
	-	-	0.5 s	Measured at 220Vac input, 60%-100% Load
Temperature Coefficient of I <sub>o</sub> set	-	0.03%/°C	-	Case temperature = 0°C ~T <sub>c</sub> max

**Note:** All specifications are typical at 25°C unless otherwise stated.

## General Specifications

Parameter	Min.	Typ.	Max.	Notes
Efficiency at 120 Vac input:				
EUK-320S150DT(TT)				
I <sub>o</sub> =1050mA	89.50%	91.50%	-	Measured at 100% load and steady-state temperature in 25°C ambient; (Efficiency will be about 2.0% lower if measured immediately after startup.)
I <sub>o</sub> =1500mA	89.00%	91.00%	-	
EUK-320S220DT(TT)				
I <sub>o</sub> =1540mA	89.00%	91.00%	-	
I <sub>o</sub> =2200mA	89.00%	91.00%	-	
EUK-320S320DT(TT)				
I <sub>o</sub> =2240mA	88.00%	90.00%	-	
I <sub>o</sub> =3200mA	88.00%	90.00%	-	
EUK-320S460DT(TT)				
I <sub>o</sub> =3220mA	88.50%	90.50%	-	
I <sub>o</sub> =4600mA	88.00%	90.00%	-	
EUK-320S670DT(TT)				
I <sub>o</sub> =4690mA	88.00%	90.00%	-	
I <sub>o</sub> =6700mA	87.00%	89.00%	-	
Efficiency at 220 Vac input:				
EUK-320S150DT(TT)				
I <sub>o</sub> =1050mA	91.50%	93.50%	-	Measured at 100% load and steady-state temperature in 25°C ambient; (Efficiency will be about 2.0% lower if measured immediately after startup.)
I <sub>o</sub> =1500mA	91.50%	93.50%	-	
EUK-320S220DT(TT)				
I <sub>o</sub> =1540mA	91.50%	93.50%	-	
I <sub>o</sub> =2200mA	91.50%	93.50%	-	
EUK-320S320DT(TT)				
I <sub>o</sub> =2240mA	90.50%	92.50%	-	
I <sub>o</sub> =3200mA	90.00%	92.00%	-	
EUK-320S460DT(TT)				
I <sub>o</sub> =3220mA	90.50%	92.50%	-	
I <sub>o</sub> =4600mA	90.00%	92.00%	-	
EUK-320S670DT(TT)				
I <sub>o</sub> =4690mA	90.50%	92.50%	-	
I <sub>o</sub> =6700mA	89.50%	91.50%	-	

## General Specifications (Continued)

Parameter	Min.	Typ.	Max.	Notes	
Efficiency at 277 Vac input: EUK-320S150DT(TT) I <sub>o</sub> =1050mA I <sub>o</sub> =1500mA EUK-320S220DT(TT) I <sub>o</sub> =1540mA I <sub>o</sub> =2200mA EUK-320S320DT(TT) I <sub>o</sub> =2240mA I <sub>o</sub> =3200mA EUK-320S460DT(TT) I <sub>o</sub> =3220mA I <sub>o</sub> =4600mA EUK-320S670DT(TT) I <sub>o</sub> =4690mA I <sub>o</sub> =6700mA	92.00% 91.50%	94.00% 93.50%	- -	Measured at 100% load and steady-state temperature in 25°C ambient; (Efficiency will be about 2.0% lower if measured immediately after startup.)	
MTBF	-	282,000 Hours	-		Measured at 220Vac input, 80%Load and 25°C ambient temperature (MIL-HDBK-217F)
Lifetime	-	86,000 Hours	-		Measured at 220Vac input, 80%Load and 70°C case temperature; See lifetime vs. Tc curve for the details
Operating Case Temperature for Safety T <sub>c_s</sub>	-40°C	-	+85°C		
Operating Case Temperature for Warranty T <sub>c_w</sub>	-40°C	-	+75°C		Case temperature for 5 years warranty
Storage Temperature	-40°C	-	+85°C		Humidity: 5%RH to 100%RH
Dimensions Inches (L × W × H) Millimeters (L × W × H)	8.82 × 3.15 × 1.57 224 × 80 × 39.7				With mounting ear 9.89 × 3.15 × 1.57 251 × 80 × 39.7
Net Weight	-	1530 g	-		

**Note:** All specifications are typical at 25°C unless otherwise stated.

## Dimming Specifications

Parameter	Min.	Typ.	Max.	Notes	
DT Models	Absolute Maximum Voltage on the Vdim (+) Pin	-20 V	-	20 V	
	Source Current on Vdim (+)Pin	200 μA	300 μA	450 μA	Vdim(+) = 0 V
	Recommended Dimming Range for 0-10V	0 V	-	10 V	
	PWM_in High Level	-	10V	-	
	PWM_in Low Level	-	0V	-	
	PWM_in Frequency Range	200 Hz	-	2 KHz	
	PWM_in Duty Cycle	0%	-	100%	

## Dimming Specifications (Continued)

Parameter		Min.	Typ.	Max.	Notes
TT Models	Dimming Level	10%	-	100%	Default is Traditional Timer. Dimming mode set to Self Adapting-Midnight or Self Adapting-Percentage in PC interface.
	Hold Time	0 Hours	-	18 Hours	
	Fade Time	0 Minutes	-	60 Minutes	
	Dimming Step	1	-	6	
Dimming Output Range	EUK-320S150DT(TT) EUK-320S220DT(TT) EUK-320S320DT(TT) EUK-320S460DT(TT) EUK-320S670DT(TT)	10%loset	-	loset	1050 mA ≤ loset ≤ 1500 mA 1540 mA ≤ loset ≤ 2200 mA 2240 mA ≤ loset ≤ 3200 mA 3220 mA ≤ loset ≤ 4600 mA 4690 mA ≤ loset ≤ 6700 mA
	EUK-320S150DT(TT) EUK-320S220DT(TT) EUK-320S320DT(TT) EUK-320S460DT(TT) EUK-320S670DT(TT)	105 mA 154 mA 224 mA 322 mA 469 mA	-	loset	105 mA ≤ loset < 1050 mA 154 mA ≤ loset < 1540 mA 224 mA ≤ loset < 2240 mA 322 mA ≤ loset < 3220 mA 469 mA ≤ loset < 4690 mA

## Safety & EMC Compliance

Safety Category	Standard
UL/CUL	UL8750,CAN/CSA-C22.2 No. 250.13
CE	EN 61347-1, EN61347-2-13
EAC	ГОСТ Р МЭК 61347-1, ГОСТ IEC 61347-2-13
EMI Standards	Notes
EN 55015/ KN 15 <sup>(1)</sup>	Conducted emission Test & Radiated emission Test
EN 61000-3-2	Harmonic current emissions
EN 61000-3-3	Voltage fluctuations & flicker
FCC Part 15 <sup>(1)</sup>	ANSI C63.4 Class B
	This device complies with Part 15 of the FCC Rules. Operation is subject to the following two conditions: [1] this device may not cause harmful interference, and [2] this device must accept any interference received, including interference that may cause undesired Operation.
EMS Standards	Notes
EN 61000-4-2	Electrostatic Discharge (ESD): 8 kV air discharge, 4 kV contact discharge
EN 61000-4-3	Radio-Frequency Electromagnetic Field Susceptibility Test-RS
EN 61000-4-4	Electrical Fast Transient / Burst-EFT
EN 61000-4-5	Surge Immunity Test: AC Power Line: Differential Mode 6 kV, Common Mode 10 kV <sup>(2)</sup>
EN 61000-4-6	Conducted Radio Frequency Disturbances Test-CS
EN 61000-4-8	Power Frequency Magnetic Field Test
EN 61000-4-11	Voltage Dips

## Safety & EMC Compliance (Continued)

EMS Standards	Notes
EN 61547	Electromagnetic Immunity Requirements Applies To Lighting Equipment

- Note:** (1) This LED driver meets the EMI specifications above, but EMI performance of a luminaire that contains it depends also on the other devices connected to the driver and on the fixture itself.
- (2) To perform electric strength (hi-pot) testing, the "GDT ground disconnect" (nut and metal lock sheet) on the driver end-cap should be removed temporarily to prevent the internal gas discharge tube from conducting (as allowed by IEC 60598-1 Clause 10.2). After testing is completed, these items must be reinstalled to restore line-to-earth surge protection and secure the end cap.

## Derating

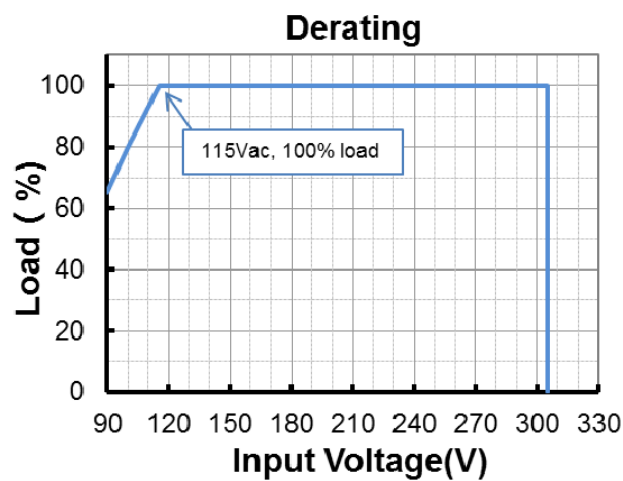

## Lifetime vs. Case Temperature

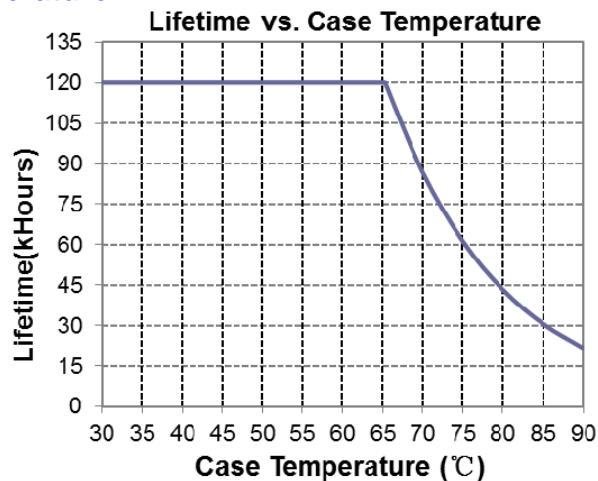

## Inrush Current Waveform

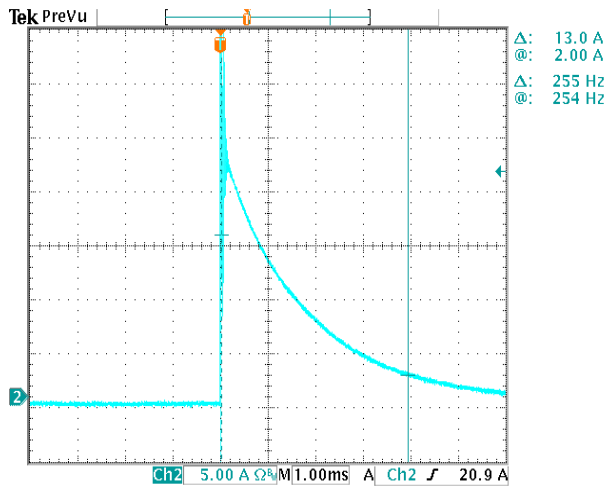

## Efficiency vs. Load

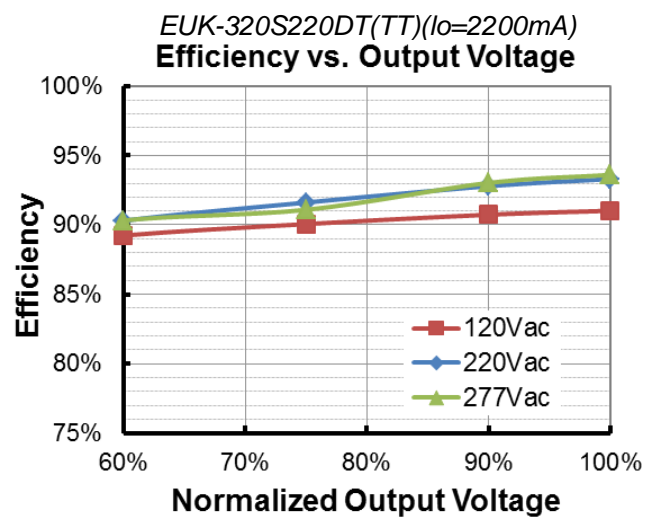
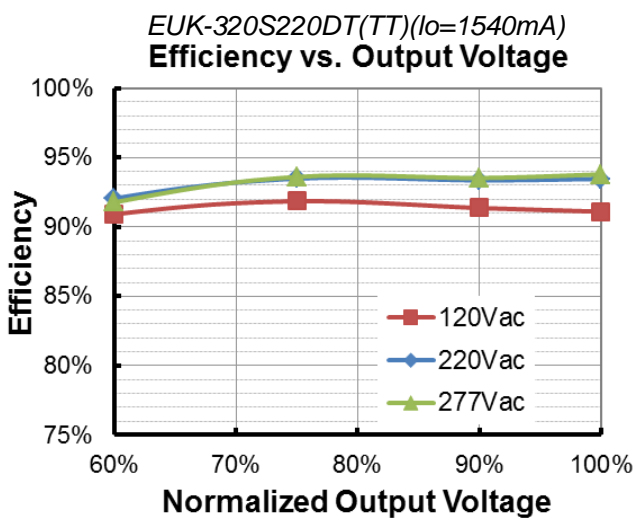
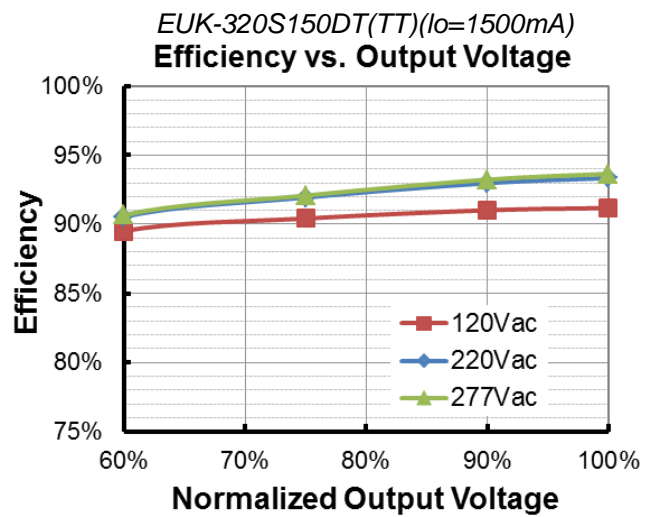
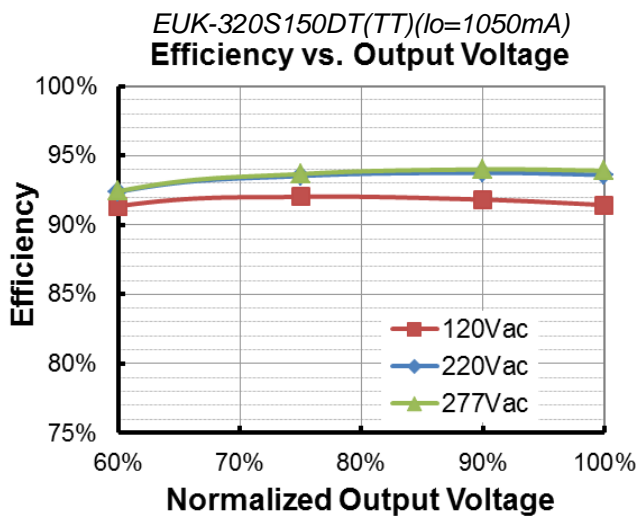



**EUK-320S320DT(TT)(I<sub>o</sub>=2240mA)  
Efficiency vs. Output Voltage**

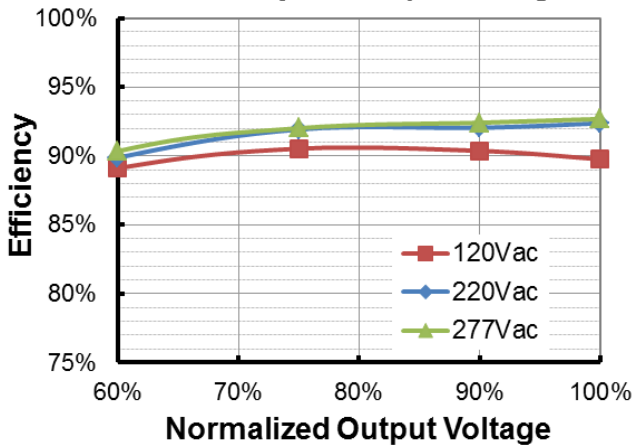

**EUK-320S320DT(TT)(I<sub>o</sub>=3200mA)  
Efficiency vs. Output Voltage**

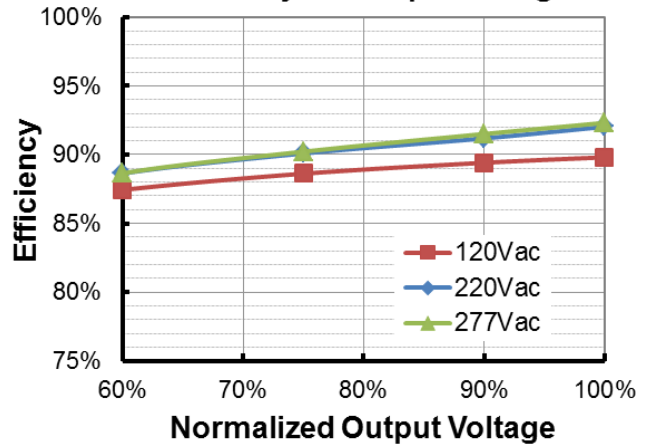

**EUK-320S460DT(TT)(I<sub>o</sub>=3220mA)  
Efficiency vs. Output Voltage**

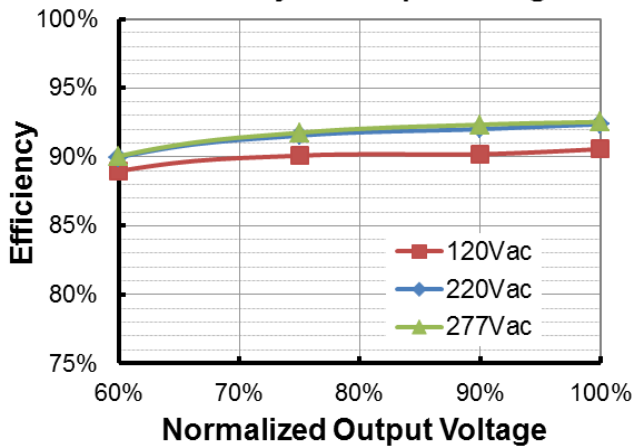

**EUK-320S460DT(TT)(I<sub>o</sub>=4600mA)  
Efficiency vs. Output Voltage**

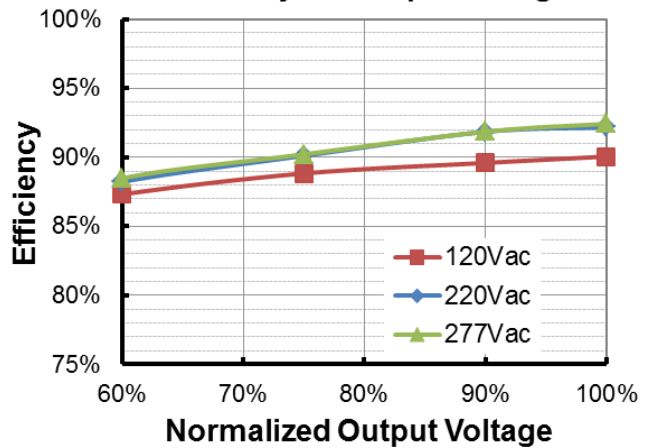

**EUK-320S670DT(TT)(I<sub>o</sub>=4690mA)  
Efficiency vs. Output Voltage**

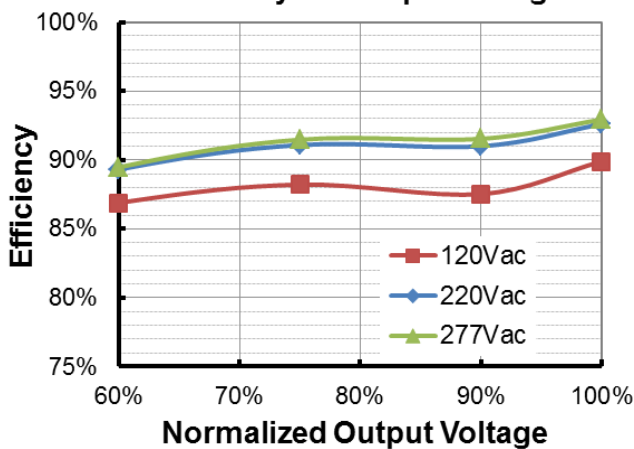

**EUK-320S670DT(TT)(I<sub>o</sub>=6700mA)  
Efficiency vs. Output Voltage**

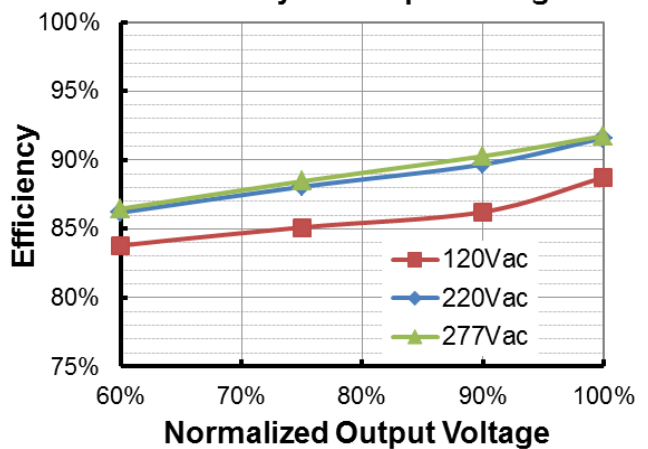

## Power Factor

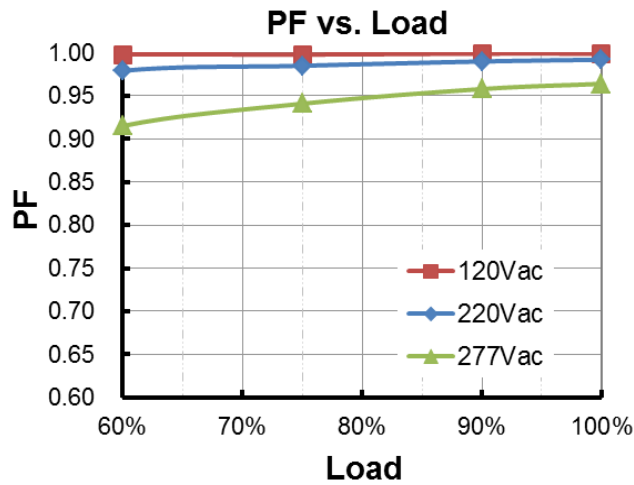

## Total Harmonic Distortion

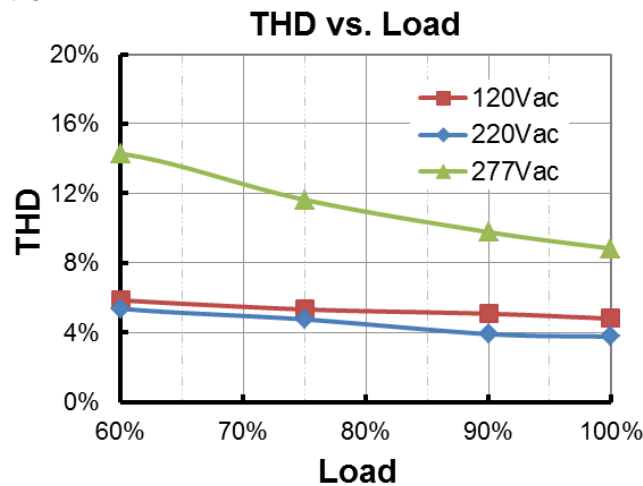

## Protection Functions

Parameter	Notes
Over Temperature Protection	Decreases output current, returning to normal after over temperature is removed.
Short Circuit Protection	Auto Recovery. No damage will occur when any output is short circuited. The output shall return to normal when the fault condition is removed.
Over Voltage Protection	Limits output voltage at no load and in case the normal voltage limit fails.

## Dimming

### ● 0-10V Dimming (Only DT models)

The recommended implementation of the dimming control is provided below.

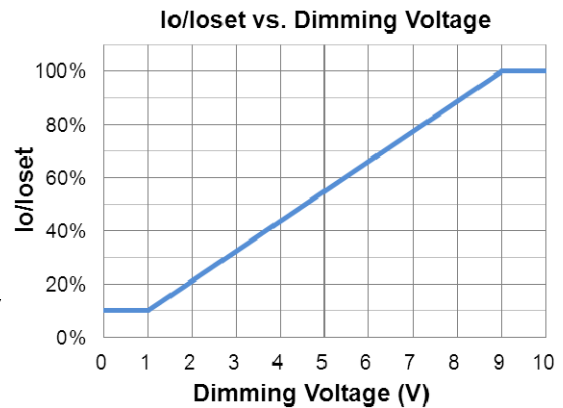
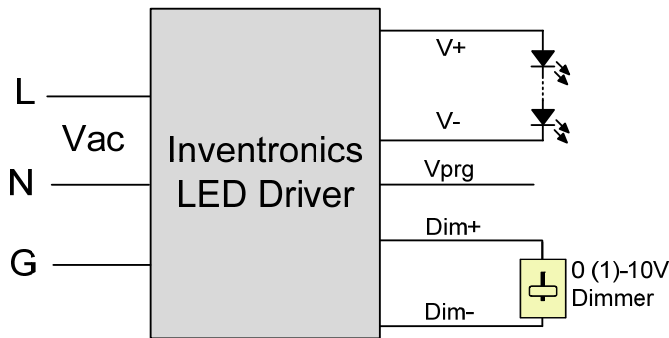

Implementation 1: Positive logic

**Notes:**

1. The dimmer can also be replaced by an active 0-10V voltage source signal or passive components like resistors and zener.
2. If 0-10V dimming is not used, Dim + should be open.

### ● 10V PWM Dimming (Only DT models)

The recommended implementation of the dimming control is provided below.

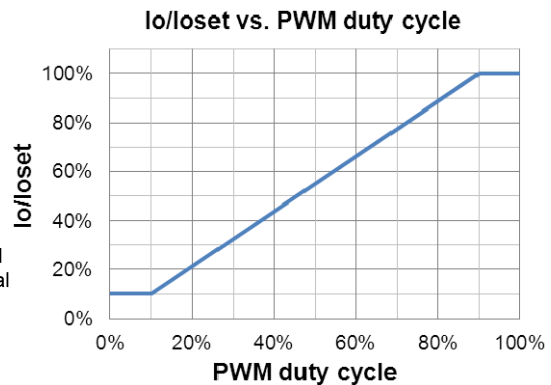
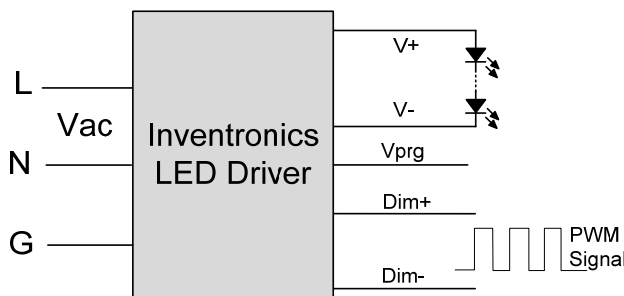

Implementation 2: Positive logic

**Notes:** If PWM dimming is not used, Dim + should be open.

### ● Time Dimming (Only TT models)

Time dimming control includes 3 kinds of modes, they are Self Adapting-Midnight, Self Adapting-Percentage and Traditional Timer.

- **Self Adapting-Midnight:** Automatically adjusts the dimming curve based on the on-time of past two days (if difference <15 minutes), assuming that the center point of the dimming curve is midnight local time.
- **Self Adapting-Percentage:** Automatically adjusts the on-time of each step by a constant percentage = (actual on-time for the past 2 days if difference <15 min) / (programmed on-time from the dimming curve).
- **Traditional Timer:** Follows the programmed timing curve after power on with no changes.

● **Output Lumen Compensation (Only TT models)**

Output Lumen Compensation (OLC) may be used to maintain constant light output over the life of the LEDs by driving them at a reduced current when new, then gradually increasing the drive current over time to counteract LED lumen degradation.

**Programming Connection Diagram**

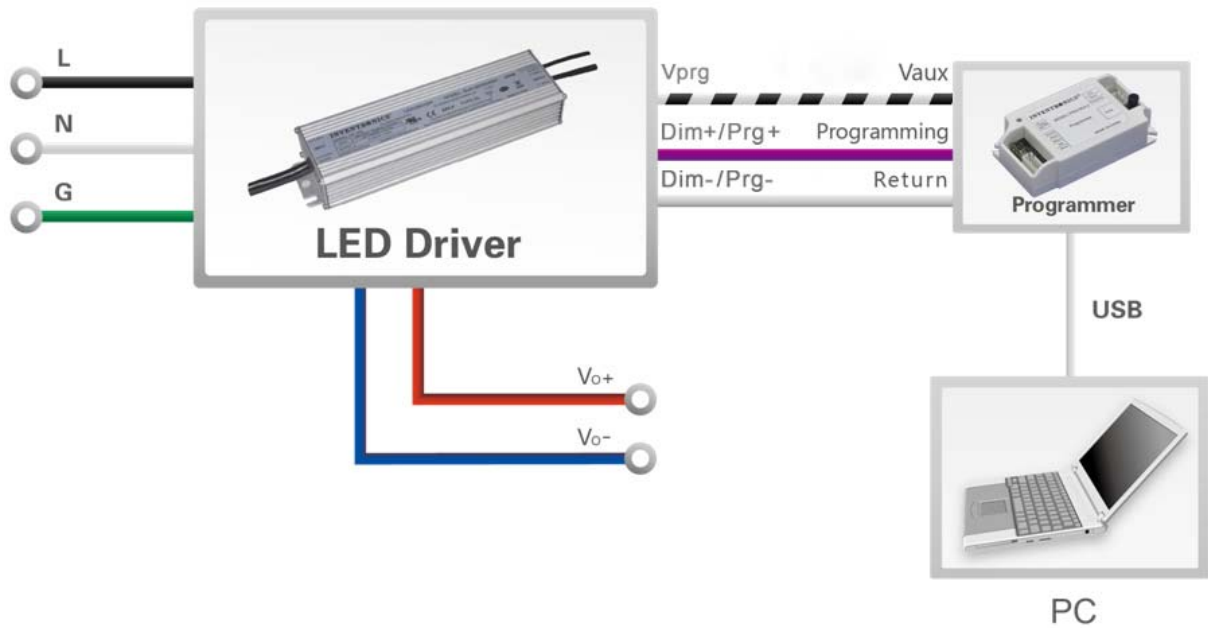

**Note:** The driver does not need to be powered on during the programming process.

● Please refer to [PRG-MUL2 Multi-Programmer datasheet](#) for details.

**Mechanical Outline**

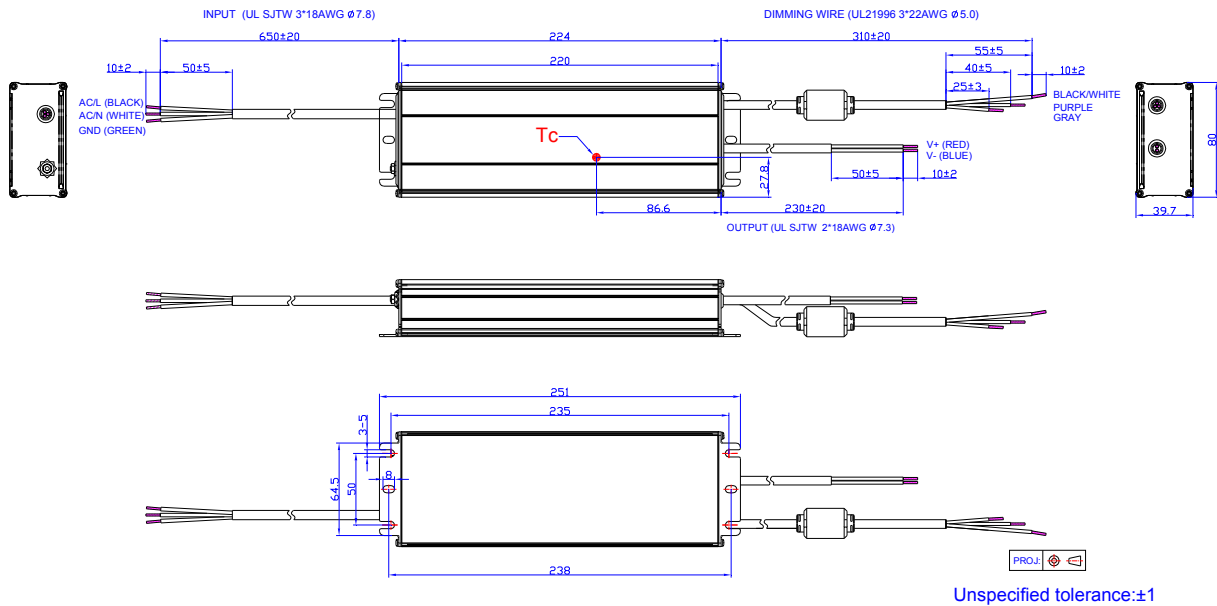

## **RoHS Compliance**

Our products comply with reference to RoHS Directive (EU) 2015/863 amending 2011/65/EU, calling for the elimination of lead and other hazardous substances from electronic products.

## Revision History

Change Date	Rev.	Description of Change		
		Item	From	To
2018-12-14	A	Datasheets Release	/	/
2019-02-14	B	Features	3 Timer Modes Dimmable (TT models)	Added
		Models	EUK-320SxxxTT	Added
		I-V Operation Area	EUK-320SxxxTT	Added
		Output Current Setting(losct) Range	EUK-320SxxxTT	Added
		Output Current Setting Range with Constant Power	EUK-320SxxxTT	Added
		No Load Output Voltage	EUK-320SxxxTT	Added
		Efficiency at 120 Vac input	EUK-320SxxxTT	Added
		Efficiency at 220 Vac input	EUK-320SxxxTT	Added
		Efficiency at 277 Vac input	EUK-320SxxxTT	Added
		Dimming Specifications	TT Models	Added
		Efficiency vs. Load	EUK-320SxxxTT	Added
2019-04-18	C	Dimming	/	Updated
		Features	/	Updated
2019-12-02	D	KCC Logo	/	Added
		EAC Logo	/	Added
		Features	6kV line-line, 10kV line-earth	DM 6kV, CM 10kV
		Features	Waterproof (IP67)	IP67
		Models	Notes (5)	Added
		Safety &EMC Compliance	EAC	Added
		Safety &EMC Compliance	EN 55015 <sup>(1)</sup>	EN 55015/ KN 15 <sup>(1)</sup>
		Safety &EMC Compliance	EN 61000-4-5	Updated
		RoHS Compliance	/	Updated