

C-Line: 2x2 & 2x4 Center Basket Troffers

5-CCT + 5-Power



2X2

2X4

Shown with Sensor Option

LED-CBT-2X2-5P40-5CCT

WATT	LUMENS
20	2,500
25	3,125
30	3,750
35	4,375
40	5,000

LED-CBT-2X4-5P50-5CCT

WATT	LUMENS
20	3,750
25	4,375
30	5,000
40	5,625
50	6,250

Detail Specification:

- Finish: White
- IP Rating: Damp Location (IP44)
- Beam Angle: 110°
- Chip: SMD 2835, R9 >50, CRI >80
- Optional CRI >90 chip available
- Operating Temperature: -40° - 114° F
- Lens: Frosted, non-yellowing
- Average life (L70) of 50,000 hours

Applications:

- General Indoor Lighting
- Fluorescent Troffer Replacement
- Utility & Storage
- Garage Structures
- Office and Meeting Rooms
- Education, Healthcare, Retail, Hospitality
- Commercial and Industrial

Product Information:

- Aluminum housing finished with corrosion free power coat
- Even light distribution
- Lightweight for easier installation
- Select-n-Switch Technology: 5-CCT + 5-Power Selectable
- Sensor models available
- Control Options:
 - Standard Sensors
 - SILVAIR Bluetooth Mesh
 - ENVISIONLS Bluetooth
 - [Click Here](#) for More Information

Driver Options:

- UNV: 120-277V 0-10V Dimmable
- Optional 347-480V step down transformer available
- THD: <15% (+/-5% tolerance), PF >0.9, 50/60Hz
- Isolated Driver
- Flicker Free

Mounting & Installation:

- Replace existing fluorescent 2x2 & 2x4 fixtures
- See installation guide for full details

Certifications:

- UL Listed for USA and CA
- DLC Premium Listed
 - 2X2 Product ID: S-0JDJWS
 - 2X4 Product ID: S-CS4N2Q
- Approved for CA T24
- 5 Year Limited Warranty
- FCC CFR 47, GCC Part 15, Subpart B:2017

Item	Sensor	Emergency	Driver	CRI	Whip
LED-CBT-2X2-5P40-5CCT 20/25/30/35/40W	(Blank) No Sensor	(Blank) No Emergency	(Blank) 120-277	(Blank) >80	(Blank) No Whip
LED-CBT-2X4-5P50-5CCT 20/25/30/40/50W	BMS Bi-Level Motion + Daylight Sensor (S-BMS-INT-1) BMS-BT Bi-Level Motion + Daylight Sensor + Bluetooth App Controlled (S-BMS-INT-1-BT) BMS-SL PIR SILVAIR Bluetooth Mesh	EMB Emergency Backup	HV 347-480V Stepdown	-90CRI	-6FLX 6' Flex

Optional Accessories (Order Separately)

Suspension Kits	Surface Mount Kits	Drywall Kits
SK-10FT-Y-LC-CB 10' Suspension Kit	2X2-SM-3" 3" Height	LED-PNL-2X2-FLNG Drywall Kit
SK-20FT-Y-LC-CB 20' Suspension Kit	2X4-SM-3" 3" Height	LED-PNL-2X4-FLNG Drywall Kit
CK-6FT-V 6' Chain Hanging Kit		

1. Custom height options available. Contact us.

Specs and model numbers are subject to change with or without notice. Customization of product is available.

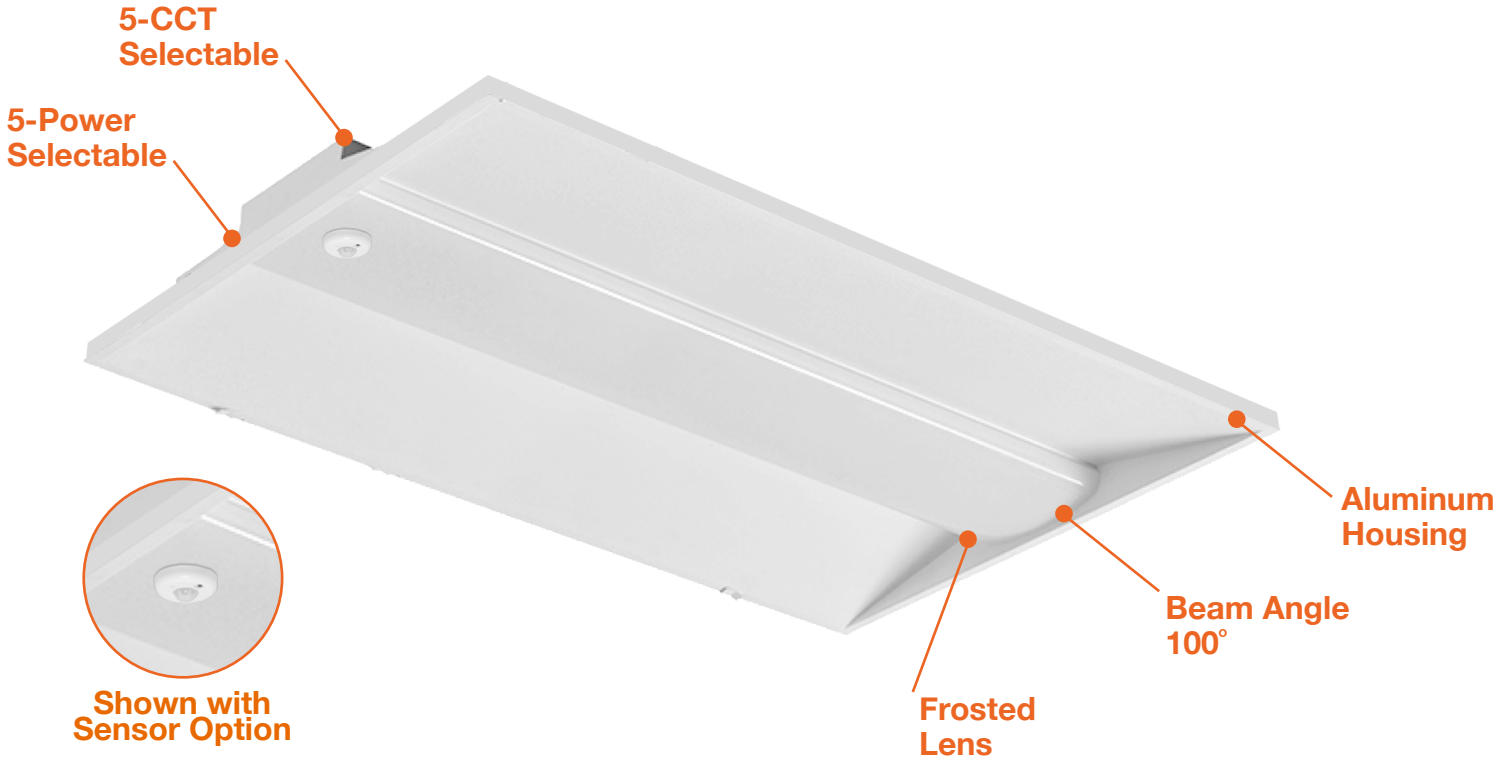

DIMENSIONS

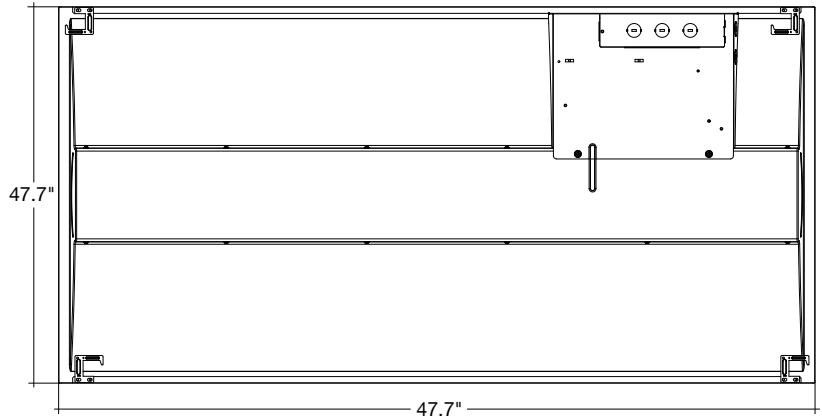
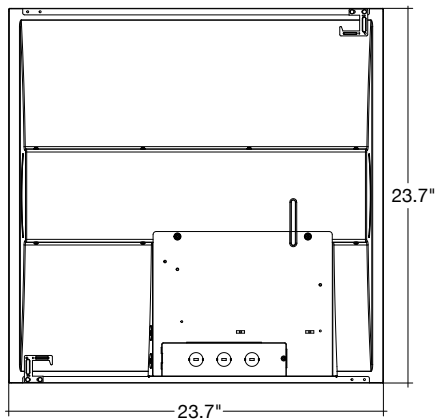
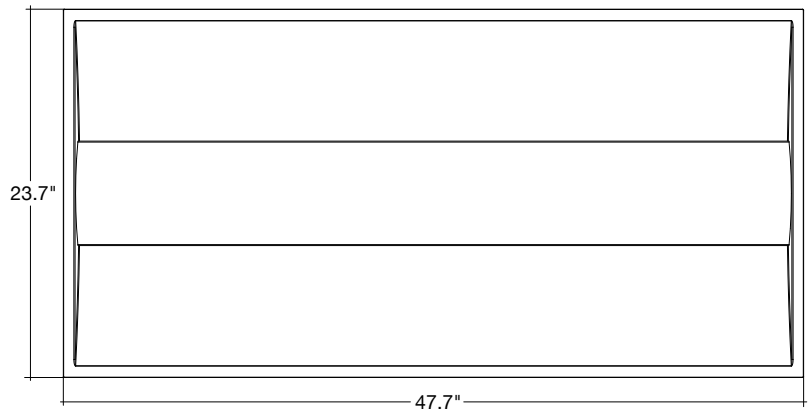
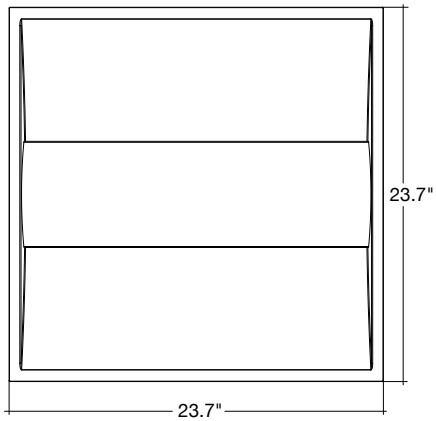

2X2

2X4

ACCESSORIES



S-LINE-R



SK-10FT-Y-LC-CB
SK-20FT-Y-LC-CB

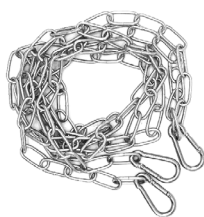

CK-6FT-V

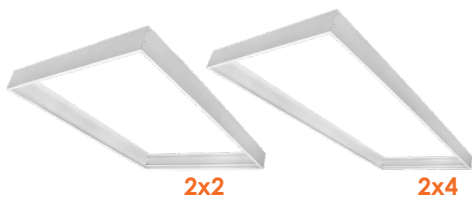

2x2

2x4



2x2

2x4

TROFFERS

Fixture Model	Voltage	Watts	Lumens	Color	CRI
LED-CBT-2X2-5P40-5CCT	120-277V	40/35/30/25/20	5000/4375/3750/3125/2500	27/30/35/40/50K	>80
LED-CBT-2X4-5P50-5CCT	120-277V	50/45/40/35/30	6250/5625/5000/4375/3750	27/30/35/40/50K	>80

BMS CONTROLLER

Model	Item Description	Voltage	Watts
S-LINE-R	Remote for S-LINE Series Sensors	12V	<1w

SENSORS

Pre-Installed Accessory Model	Description
Add '-BMS' to model #	Bi-Level Motion + Daylight Sensor Remote Required: (S-LINE-R)
Add '-BMS-BT' to model #	S-BMS-EXT-1-BT: Bi level motion + daylight sensor W/ bluetooth control (EnvisionNLS App)
Add: -BMS-SL to Model #	SILVAIR Enable Bluetooth Control: PIR/Daylight/Zoning/Monitoring

SUSPENSION KITS

Accessory	Description
SK-10FT-Y-LC-CB	10' Suspension Kit
SK-20FT-Y-LC-CB	20' Chain Hanging Kit
CK-6FT-V	6' Chain Hanging Kit

SURFACE MOUNT KITS









Accessory	Description
2X2-SM-3"	2X2 Surface Mount Kit 3" Height for all Panels and Troffers
2X4-SM-3"	2X4 Surface Mount Kit 3" Height for all Panels and Troffers

DRYWALL KITS

Accessory	Description
LED-PNL-2X2-FLNG	Flange (Drywall) Kit for Panels for all 2X2 Fixtures
LED-PNL-2X4-FLNG	Flange (Drywall) Kit for Panels for all 2X4 Fixtures

EnVisionLED™ Control Options

EnVision LED offers 3 control systems compatible with our LED Fixtures for projects of all sizes and budgets.

	Basic Controls	EnVisionLS 	EnVisionLED™ x SILVAIR 
Description	Standard Plug In Sensors	Basic Bluetooth Wireless Control	Advanced Bluetooth Wireless Control
Recommended Quantity (but not limited to)	N/A	>40-50 Nodes	>50 Nodes
Maximum Zone Quantity	N/A	100	3,000
Commissioning Tool	Remote Only	  ENVISIONLS App 	  SILVAIR App 
Commissioning Process	Individually Set via Remote	Wireless Must be done on site	Wireless- Initial linking must be done on site. Commissioning can be done via desktop remotely.
Floor Plan Upload	N/A	N/A	Yes Add a floor plan and mark luminaires & zones via desktop
Gateway	N/A	N/A	Required only for energy monitoring, advanced scheduling, automated demand response.
Individual Luminaire Control	Yes	Yes	Yes
Luminaire Grouping Zoning	N/A	Yes	Yes
High End Power Low End Power	Yes but limited (View Remote)	Yes	Yes
Cost	\$	\$\$	\$\$\$
DLC NLC Listed	N/A	Yes	Yes
Energy Monitoring & Data Reporting	N/A	N/A	Monitor energy usage per individual zone & retrofit cost savings calculation + detailed reporting



Compatible Products:

EnVision offers a variety of nodes, sensors, & gateways that are controlled via remote, ENVISIONLS Bluetooth Mesh & SILVAIR Bluetooth Mesh on all of our 0-10V dimmable fixtures.



Individual Fixture Controls: PIR Sensor, Bi-Level Dimming, Daylight

Basic Note: **-1** • ENVISIONLS Models Note: **-BT** • SILVAIR Models Note: **-SL**

	MODEL #	DESIGN	RECOMMENDED FIXTURE	FEATURES
	S-TWC-PIR-1 S-TWC-PIR-BT S-TWC-PIR-SL	Twist-C Control Sensor	Sensor Ready Fixtures: Area Lights, Canopies, Flood Lights, High Bays	All models are equipped with PIR occupancy sensing, high & low end bi-level dimming, & daylight sensing.
	S-TWC-90 + S-TWC-PIR-1 S-TWC-90 + S-TWC-PIR-BT S-TWC-90 + S-TWC-PIR-SL	Twist-C Control Sensor + 90 Degree Arm	Cylinders, Strips, Wall Packs	
	S-AUD-PIR-1 S-AUD-PIR-BT S-AUD-PIR-SL	2.5m Audio Jack	Panels & Troffers	
	S-SN-PIR-1 S-SN-PIR-BT S-SN-PIR-SL	Snap In Sensor	Troffers & Wraps	

Group Controls ENVISIONLS Models Note : **-BT** • SILVAIR Models Note: **-SL**

	MODEL #	DESIGN	VOLTAGE	FEATURES	RECOMMENDED FEATURES
	S-CM-PIR-LV-BT S-CM-PIR-LV-SL	Ceiling Mounted PIR Sensor	12-24V	PIR Sensor, Bi-Level Dimming, Daylight, 360° detection, 12' Max Mounting Height	Connects to 0-10V dimmable fixtures
	S-WM-PIR-CUNV-BT S-WM-PIR-CUNV-SL	Wall Mounted PIR Occupancy Sensor, Bi-Level Dimming, Daylight	120-277V	On/Off PIR occupancy sensor, 180° detection, 30' detection @ 4' Mounting Height	Connects to LED fixtures
	S-WS-120V-USB-SL		120V	Dimming Wall Socket, Two Sockets	Floor Lamps, Other Lamps

Gateway (Silvair Only) 4.5–5.5 V DC, 2A Power over Ethernet 36–57 V DC

	MODEL #	DESIGN	VOLTAGE	FEATURES	RECOMMENDED FEATURES
	SGW-102	Wall or Ceiling Mounted	POE	Advanced Energy Monitoring Control	Connects to Silvair Controls. Gateway is not required.