



D21CC80UNVTZ-D

UNV Dimmable LED Driver w/ Tuning

- 2100mA Constant Current Output
- Class 2, 80W Output
- 0-10V Dimming



Performance	
Input Voltage	120 ~ 277 Vac
Input Current Max	0.77 /120V 0.33/277V
Input Power Max	93W
Input Frequency	50 - 60 (Hz)
Power Factor*	> 0.95
THD max*	< 20 %
Output Voltage	15V to 38V
Max. Output Current	2100mA
Min Dimming Current	40mA
Output Power	80W
Line Regulation	±3 %
Load Regulation	±5 %
Output Current Ripple	<10% (Pk-Pk/avg)
Inrush Current	120V: 18A / 65uS
Peak / >50% Duration	277V: 32A / 30uS

- Inrush current complies with NEMA 410
 * Refer to charts for additional information

Environmental	
EMI and RFI	Meets FCC part 15 (Class A) Non-Consumer Limits
Min. Operating Temperature	-40°C (-40°F)
Storage Temperature	-40°C to 85°C (-40°F to 185°F)
tc	85°C (185°F) max
Protection Rating	UL Dry & Damp
Transient Protection	IEEE C62.41 2.5kV/2.5kV

Physical	
Length	16.88 in (428.7 mm)
Width	1.25 in (31.8 mm)
Height	1.00 in (25.4 mm)
Mounting Length	16.28 in (413.5 mm)
Weight (lbs)	1.25
Wire Trap / Plug-in Connectors for 18 AWG Solid Wire	

Protection:
Short Circuit and Open Circuit

Safety:
UL 8750 & CSA 250.13-12
Type TL

Ordering Information		
Order Number	Description	Qty/Carton
D21CC80UNVTZ-D10C	Standard Product	10

*Consult Factory for Tuning ordering information

Wiring Diagram:

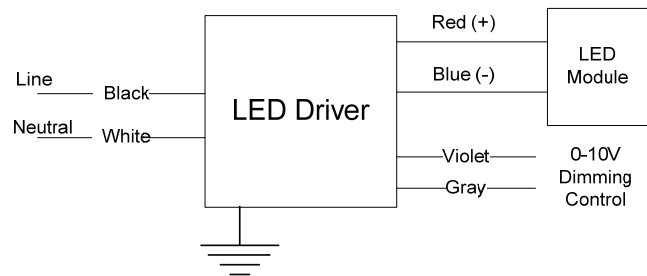



D21CC80UNVTZ-D

Programmable Tuned Output Settings

- This Everline LED Driver can be configured to set its current output to a selected fraction of their maximum rated design level. This function is called tuning (or also high-end trim) and it can be implemented with the LDTC01A using the Selector rotary switches. Tuning assignments are stored in driver memory and are not lost when power is removed. All factory produced drivers are tuned to maximum output unless otherwise noted on the label.
- Tuning SET Levels are listed in the table to the right. The SET Level corresponds to an associated Output Current value.
- Refer to application note EVD06 at www.unvlt.com for additional information.

Set Value	Output Current (A)
100	2.100
99	2.080
98	2.059
97	2.039
96	2.018
95	1.997
94	1.976
93	1.955
92	1.934
91	1.913
90	1.892
89	1.871
88	1.850
87	1.829
86	1.808
85	1.787
84	1.766
83	1.745
82	1.723
81	1.702

Set Value	Output Current (A)
80	1.681
79	1.660
78	1.638
77	1.617
76	1.596
75	1.574
74	1.553
73	1.532
72	1.510
71	1.489
70	1.467
69	1.446
68	1.425
67	1.403
66	1.382
65	1.360
64	1.339
63	1.318
62	1.296
61	1.275

Set Value	Output Current (A)
60	1.253
59	1.232
58	1.211
57	1.189
56	1.168
55	1.147
54	1.125
53	1.104
52	1.083
51	1.062
50	1.041
49	1.019
48	0.998
47	0.977
46	0.956
45	0.935
44	0.914
43	0.893
42	0.872
41	0.851
40	0.830



Application and operation performance specification information subject to change without notification.



D21CC80UNVTZ-D

0-10V Dimming

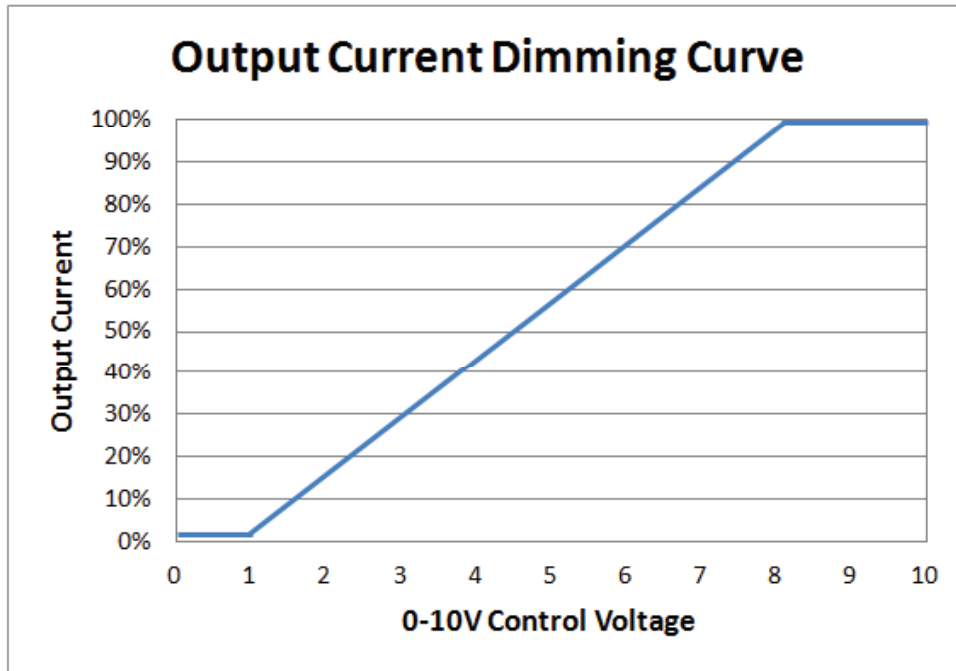

0-10V Analog Dimming Interface

- Analog 0 to 10 vDC Voltage Control
- Use Violet (+) & Gray (-) for connection to 0-10vDC.
- 10v = maximum output, 0v = minimum output
- Wiring Violet & Gray together provides min. light output.
- Capping Violet & Gray separately provides 100% light output.
- 0-10V interface must be wired as a Class 2 Circuit.
- Driver will source a maximum of 200uA for control needs.
- Controller must sink current from the 0-10V control leads.



Application and operation performance specification information subject to change without notification.



D21CC80UNVTZ-D

Performance: Efficiency, THD, & Power Factor

Typical performance measurements are shown. The charts are to be used as a guideline and not for specification use.

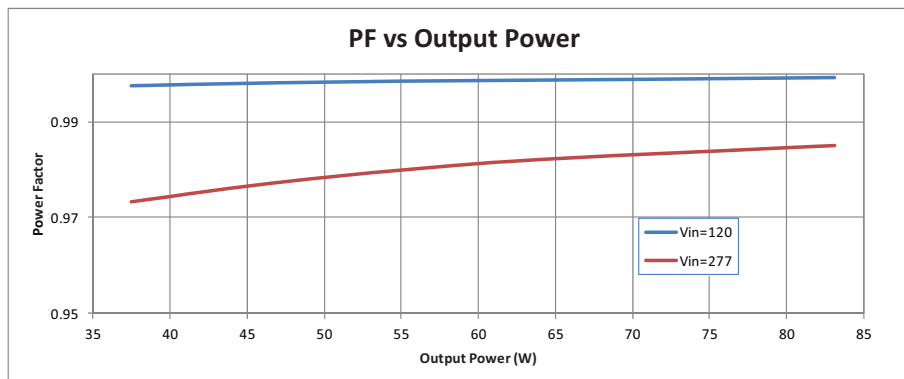
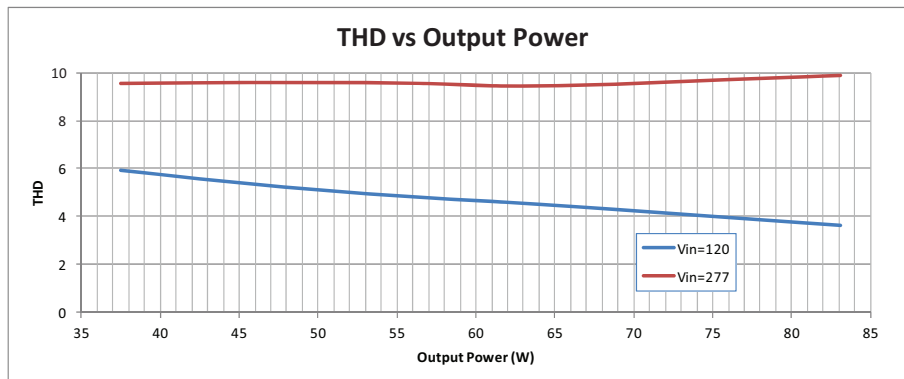
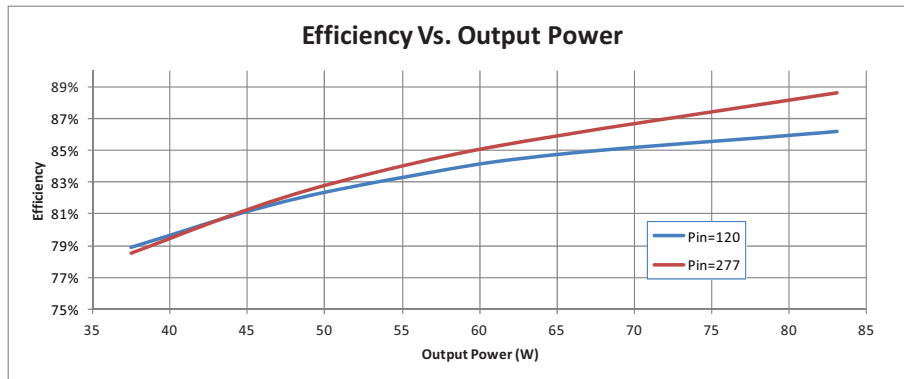

Output power based on maximum rated output current and varying load voltages.



Application and operation performance specification information subject to change without notification.



D21CC80UNVTZ-D

Life vs. Driver Tcase

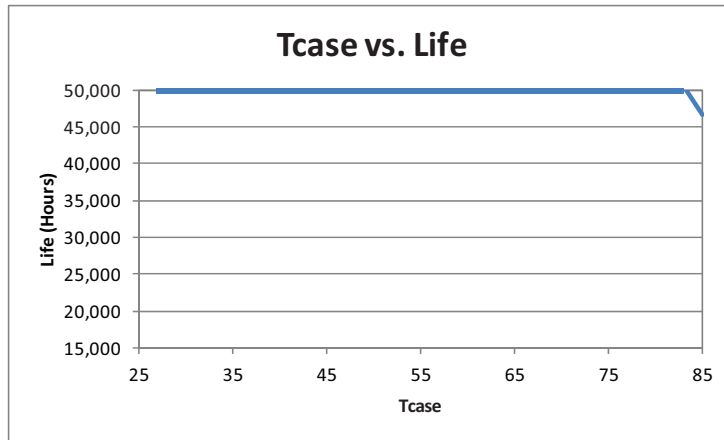

The Data curve provided predicts the LED Driver life based on the case temperature measured at the Tc location identified on the label or specification sheet. The Telecordia SR-332 standard is used to generate the prediction curves.

Dimensional Diagram

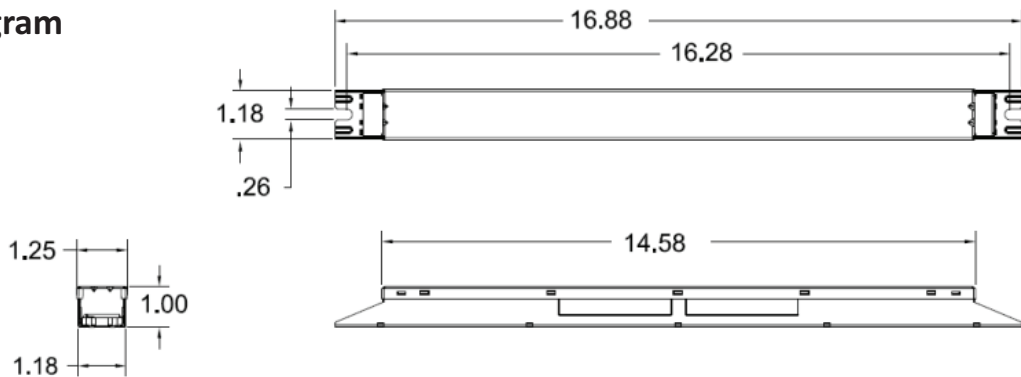

Tc Location:

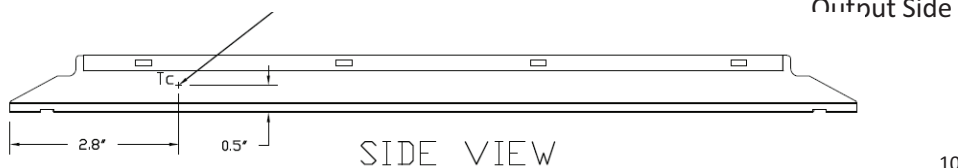

10



Application and operation performance specification information subject to change without notification.



D21CC80UNVTZ-D

Conditions of Acceptability –

1. The drivers shall be installed in compliance with the applicable requirements of the end-product standard for, mounting, spacing, casualty and segregation.
2. These Drivers were evaluated as Type TL (Temperature Limited) for use at a $T_{ref\ max}$ and Measured T_{ref} temperature at Tref as shown in the table below. See ILL. 5 for the T_c location on the units:

Model	$T_{ref\ max}$	Measured T_{ref} @ 40°C Ambient Temperature
D21CC80UNVTZ-D	90°C	83°C

3. The maximum measured leakage current from the accessible driver enclosure and the accessible Class 2 output were as follows:

Model	Maximum Measured Leakage Current MIU	
	120 V	277 V
D21CC80UNVTZ-D	-	0.48

4. The case must be reliably connected to earth ground in the end use.
5. The output of model D21CC80UNVTZ-D is “LED DRIVER CLASS 2”, Low Voltage Limited Energy “LVLE”, per CSA Informs, Lighting Products No. 66 (Ref No: I13-020). Therefore, the output and associated circuits should not be accessible to the user in the end-use application
6. When drivers are reprogramed at the end-use application facility, the driver shall be provided with a label that specifies the programmed output current setting and output voltage.

The marking may be applied directly onto the Luminaire adjacent to the driver. The applied marking shall include the programmed output current setting along with the output voltage

7. The dimming circuit is part of the isolated class 2 output with maximum available output parameters that are within the maximum allowable limits for Class 2, inherently limited as specified in the UL 1310 standard. The dimming circuits are suitable only for Class 2 wiring methods.
8. The drivers have been evaluated at the following temperature test condition with the results shown in the table below. See ILL. 5 for the T_c location on the units:

Model	Operating Primary Voltage, V_{rms}	Output Load	Maximum Case Temperature (T_c)	Maximum Ambient
D21CC80UNVTZ-D	120	2.1 A, 80 W	85°C	41°C
D21CC80UNVTZ-D	277	2.1 A, 80 W	85°C	52°C

FCC Statement: This device complies with part 15 of the FCC Rules. Operation is subject to the following two conditions: (1) This device may not cause harmful interference, and (2) this device must accept any interference received, including interference that may cause undesired operation.

Warranty:

Universal Lighting Technologies warrants to the purchaser that each power supply will be free from defects in material or workmanship for a period of 5 years from the date of manufacture when properly installed per instructions and under normal operating conditions of use. Call 1-800-225-5278 for technical assistance.



Application and operation performance specification information subject to change without notification.