

# LUXRITE®

## LED CANLESS - SPOTLIGHT SHERMAN COLLECTION



CRI  
90

COLOR SELECTABLE  
2700K 3000K 3500K 4000K 5000K

HIGH  
OUTPUT

DIMMABLE  
TRIAC

IC  
RATED

AIR  
TIGHT

WET  
LOCATION  
RATED

120V

5  
YEAR  
WARRANTY

ETL  
Intertek

**LR23415**  
LED/URDL2/5CCT/RD/HO



**LR23416**  
LED/URDL2/WFL/5CCT/RD/HO



FRONT VIEW

APERTURE	2"
DISTRIBUTION	INTERCHANGEABLE
APPLICATION	NEW CONSTRUCTION & REMODEL

## ELECTRICAL

POWER	15W
INPUT VOLTS	120V
INPUT CURRENT	150mA
FREQUENCY	60Hz
DIMMING TYPE	TRIAC
DIMMING RANGE	10-100%
FEED WIRE GAUGE	18AWG
BREAKER SPECIFICATION (15A @120V)	79pcs*

\*Mathematically estimated value. Actual capacity may vary by breaker type and installation environment.

## PHOTOMETRIC

COLOR CCT	2700K/3000K/3500K/4000K/5000K
CRI	90
LUMEN	LR23415: 1000lm LR23416: 1000lm
EFFICACY	67lm/w
BEAM ANGLE	LR23415: 38° LR23416: 60°

## CERTIFICATIONS & SAFETY

LR23415	ETL
LR23416	ETL
IP RATING	IP-54
WET LOCATION	YES
IC RATED	YES
AIR TIGHT	YES
OPERATING TEMP.	-4°F to 104°F
COST/YR	\$ 1.81
WARRANTY	3 YR

## MATERIAL & APPLICATION

HEAT SINK	DIE-CAST ALUMINUM
TRIM	ALUMINUM
LENS	PC ACRYLIC
CUTOUT	Ø2.83"
MOUNTING TYPE	RECESSED
AREA OF APPLICATION	RESIDENTIAL, COMMERCIAL
CEILING TYPE	DRYWALL, WOOD

## DRIVER

MODEL	DESCRIPTION	POWER	INPUT VOLTS	INPUT CURRENT	FREQUENCY	INPUT POWER	OUTPUT VOLTAGE	DIMENSIONS	KNOCKOUTS
	INCLUDED DRIVER	15W	120V	150mA	60Hz	15W max	36V DC	3.85"L X 2.32"W X 1.53"H	4
LR23418*	LED/URDL2/DRIVER/UNV/0-10V	18W	120-277V	150mA	60Hz	15W max	36V DC	5.43"L X 2.20"W X 2.20"H	2

MODEL	DESCRIPTION	EM POWER	INPUT VOLTS	INPUT CURRENT	FREQUENCY	INPUT POWER	OUTPUT VOLTAGE	RECHARGE TIME	EMERGENCY TIME
LR35126**	LED/EMR/15W/AC/SF/E	15W	100-347V	100mA	50/60Hz	12W max	170V DC	24HR	90MINS

\*AMBIENT TEMPERATURE: 41°F ~ 122°F  
\*\*SOLD SEPARATELY

## DIMENSIONS

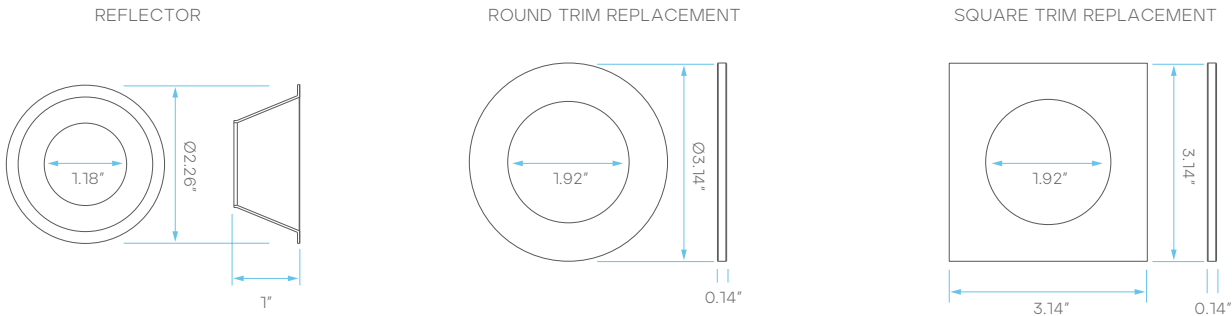
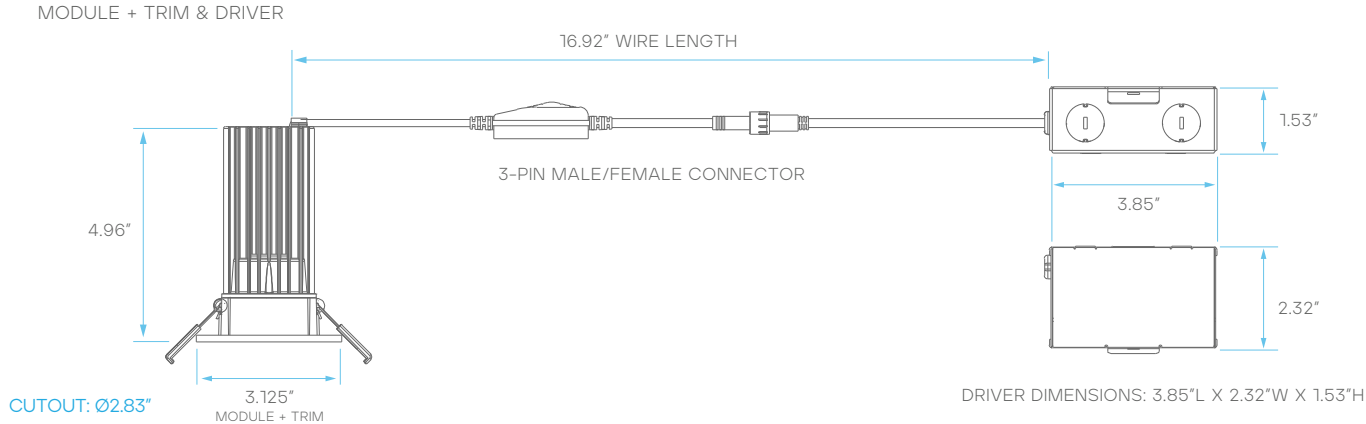

## PLATE COMPATIBILITY\*

\*SOLD SEPARATELY

LR41010  
KNOCKOUT  
L1

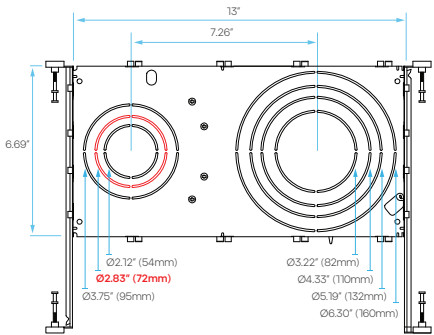

LR41004  
KNOCKOUT  
1

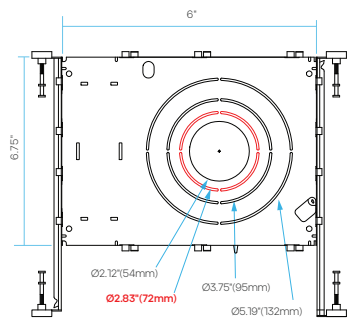

LR41011  
KNOCKOUT  
1

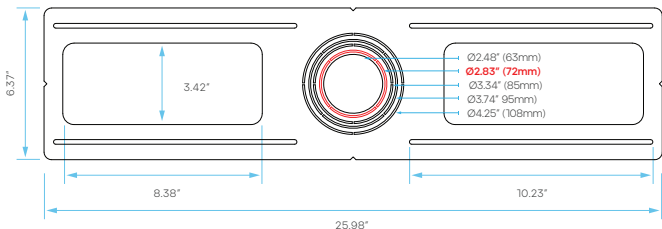

## INTERCHANGEABLE REFLECTOR OPTIONS\*

\*SOLD SEPARATELY

	MODEL	DESCRIPTON	SIZE	FINISH	SHAPE	APPLICATION
	LR23420	LED/URDL2/RFL/CH	2"	CHROME	ROUND	FIXED
	LR23421	LED/URDL2/RFL/BS	2"	BRASS	SQUARE	FIXED
	LR23422	LED/URDL2/RFL/BZ	2"	BRONZE	ROUND	FIXED
	LR23423	LED/URDL2/RFL/BK	2"	BLACK	SQUARE	FIXED
	LR23424 <small>INCLUDED</small>	LED/URDL2/RFL/WT	2"	WHITE	ROUND	FIXED











## INTERCHANGEABLE TRIM OPTIONS\*

\*SOLD SEPARATELY

	MODEL	DESCRIPTON	SIZE	FINISH	SHAPE	APPLICATION
	LR23430	LED/URDL2/TRM/RD/CH	2"	CHROME	ROUND	FIXED
	LR23431	LED/URDL2/TRM/RD/CP	2"	COPPER	ROUND	FIXED
	LR23432	LED/URDL2/TRM/RD/BZ	2"	BRONZE	ROUND	FIXED
	LR23433	LED/URDL2/TRM/RD/BK	2"	BLACK	ROUND	FIXED
	LR23434 <small>INCLUDED</small>	LED/URDL2/TRM/RD/WT	2"	WHITE	ROUND	FIXED
	LR23435	LED/URDL2/TRM/RD/BN	2"	BRUSHED NICKEL	ROUND	FIXED
	LR23436	LED/URDL2/TRM/RD/BS	2"	BRASS	ROUND	FIXED
	LR23450	LED/URDL2/TRM/SQ/CH	2"	CHROME	SQUARE	FIXED
	LR23451	LED/URDL2/TRM/SQ/CP	2"	COPPER	SQUARE	FIXED

## INTERCHANGEABLE REFLECTOR OPTIONS\*

\*SOLD SEPARATELY

	MODEL	DESCRIPTON	SIZE	FINISH	SHAPE	APPLICATION
	LR23452	LED/URDL2/TRM/SQ/BZ	2"	BRONZE	SQUARE	FIXED
	LR23453	LED/URDL2/TRM/SQ/BK	2"	BLACK	SQUARE	FIXED
	LR23454	LED/URDL2/TRM/SQ/WT	2"	WHITE	SQUARE	FIXED
	LR23455	LED/URDL2/TRM/SQ/BN	2"	BRUSHED NICKEL	SQUARE	FIXED
	LR23440	LED/URDL2/TRM/SA	2"	WHITE	ROUND	SLOT APERTURE
	LR23441	LED/URDL2/TRM/WW	2"	WHITE	ROUND	WALL WASHER
	LR23442	LED/URDL2/TRM/PH	2"	WHITE	ROUND	PIN HOLE
	LR23443	LED/URDL2/TRM/SH	2"	WHITE	ROUND	SQUARE HOLE
	LR23444	LED/URDL2/TRM/IP	2"	WHITE	ROUND	WATEPROOF
	LR23465	LED/URDL2/RPLT/2HD/WT	2"	WHITE	2-HEAD ROUND	FIXED
	LR23466	LED/URDL2/RPLT/2HD/BK	2"	BLACK	2-HEAD ROUND	FIXED

## WIRE EXTENDER OPTIONS

\*SOLD SEPARATELY



MODEL	TYPE	WIRE GAUGE
LR41051	5' - 3 PIN	22 AWG
LR41053	10' - 3 PIN	22 AWG
LR41055	20' - 3 PIN	22 AWG

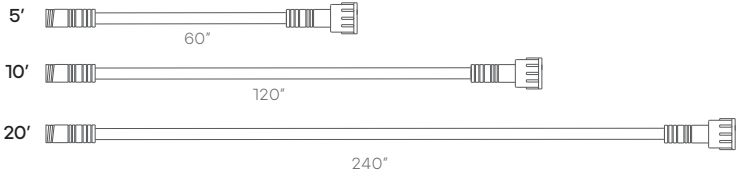

## WIRING DIAGRAM

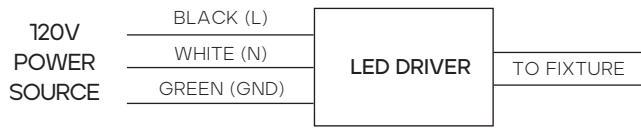

## SUGGESTED COMPATIBLE DIMMER\*

LUTRON	CTCL-153P
	DVCL-153PDH
LEVITON	DVCL-153P
	6672
PASS & SEYMOUR	6674
	HCL453PTCCCV6

\*Dimmer performance may vary based on load, wiring, and installation conditions. Inclusion on this chart does not guarantee compatibility for every installation, and omission does not indicate incompatibility. Refer to the dimmer manufacturer's installation instructions and verify minimum load requirements to avoid field issues.

## PACKAGING

MODEL	STYLE	INNER BOX DIMENSIONS	MASTER CARTON DIMENSIONS	CASE
LR23415	INNER BOX + MASTER CARTON	6.10" X 4.13" X 5.70"	12.59" X 5.11" X 7.08"	18
LR23416	INNER BOX + MASTER CARTON	6.10" X 4.13" X 5.70"	12.59" X 5.11" X 7.08"	18

## LuxiFlow™ PHOTOMETRICS

Luxrite® LuxiFlow® tool is for informational purposes only, it is not intended to provide lighting or electrical advice.

### LUMINOUS INTENSITY DISTRIBUTION DIAGRAM

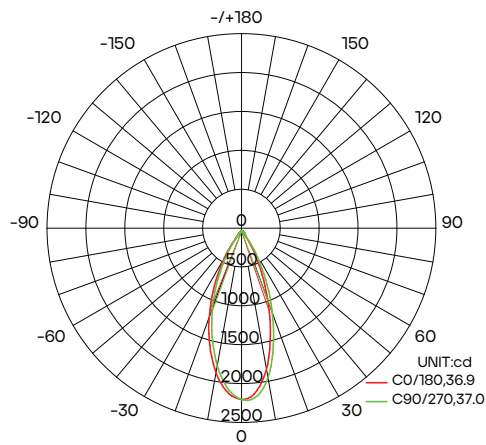

AVERAGE BEAM ANGLE(50%):36.9 DEG

\*DIAGRAM SHOWING LR23415 AT 2700K

### CO PLANE ISOLUX DIAGRAM (UNIT:lx)

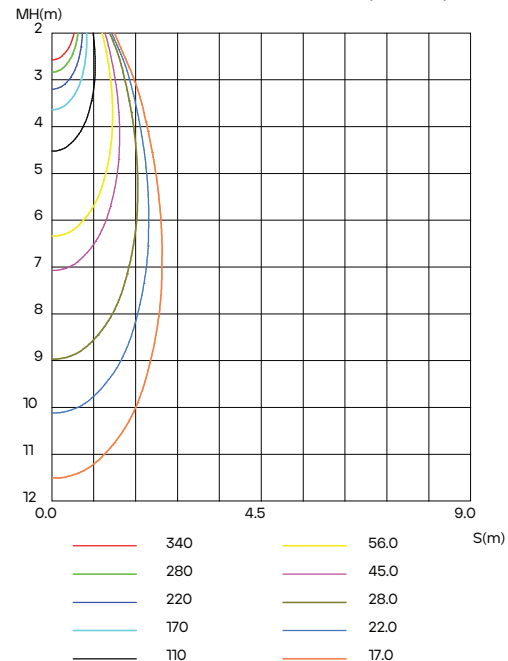

Luxrite® Luxiflow® tool is for informational purposes only, it is not intended to provide lighting or electrical advise.

### LUMINOUS INTENSITY DISTRIBUTION DIAGRAM

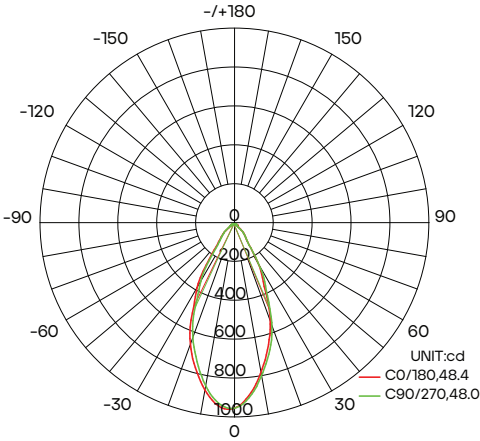

AVERAGE BEAM ANGLE(50%): 48.2 DEG

\*DIAGRAM SHOWING LR23416 AT 2700K

### C0 PLANE ISOLUX DIAGRAM (UNIT:lx)

