

GENERAL INSTALLATION GUIDELINES FOR LED EMERGENCY DRIVER

IMPORTANT SAFE PRACTICES

When using electrical equipment and this lighting device basic safety precaution should be followed at all times including but not limited to the following:

**PLEASE READ CAREFULLY AND FOLLOW ALL INSTRUCTIONS FOR YOUR OWN SAFETY
PLEASE READ AND FOLLOW THESE INSTRUCTIONS**

The manual shall include instructions for installation, operation, and maintenance recommended by the manufacturer. The instructions shall warn the user that all servicing should be performed by qualified personnel.

The instructions for inverter/charger packs limited to specific ballasts / LED Drivers shall clearly state the type and wattage of loads and ballasts or LED Drivers to which the unit is intended to be connected, unless this information is clearly marked on the product.

IMPORTANT: Do not connect battery until fixture is installed.

IMPORTANT: An un-switched AC power source of 120VAC to 277VAC is required.

This device is designed for use in fixtures listed for **dry and damp locations**.

ATTENTION: Convient Aux Emplacements Mouillés.

CAUTION: Use with grounded, UL Listed, dry or damp location rated fixtures.

CAUTION: Make sure all electrical connections conform to the National Electrical Code and all applicable local regulations.

CAUTION: Do not let power supply cords touch hot surfaces.

CAUTION: Do not mount near gas or electric heaters.

CAUTION: Do not use outdoors.

CAUTION: Battery is rechargeable Ternary lithium battery type and must be recycled or disposed of properly. Do not use this emergency driver with accessory equipment other than recommended by manufacturer; failure to follow this may cause an unsafe condition. Servicing should only be performed by qualified service personnel. Do not use this emergency driver for other than intended use.

CAUTION: Service by Qualified Personnel Only. De-energize before opening.

CAUTION: See instructions for derangement signal calibration.

CAUTION: Equipment should be mounted in locations and at heights where it will not readily be subjected to tampering by unauthorized personnel.

SAVE THESE INSTRUCTIONS

GENERAL INSTALLATION GUIDELINES FOR LED EMERGENCY DRIVER

IMPORTANT SAFE PRACTICES

When using electrical equipment and this lighting device basic safety precaution should be followed at all times including but not limited to the following:

CAUTION: For use with a metal enclosed wiring system” or equivalent.

CAUTION: RISK OF SHOCK - DISCONNECT EMERGENCY AND NORMAL INPUT POWER SOURCES BEFORE SERVICING.

ATTENTION: RISQUE DE CHOC - COUPER L'ALIMENTATION NORMALE ET DE SECOURS AVANT DE PROCÉDER À L'ENTRETIEN.

IMPORTANT: The output EM power will be the maximum of connected battery unless programmed to a lesser value. EM output power will not exceed the battery rating.

IMPORTANT: Indicator (LED light) illuminated indicates battery in charge mode when AC power is applied.

It is recommended and required by applicable code to test emergency function to ensure proper operation of the system; push the test switch for sixty (60) seconds every 30 days to ensure the emergency driver is functioning as LED light source illuminated. Conduct a ninety minute (90) discharge test one time (1) per year; LED light source should be illuminated for a minimum of ninety minutes (90).

ASSEMBLY and FIELD INSTALLATION WIRING: WARNING: AC power must be off before proceeding with assembly or installation of emergency driver.

TESTING SYSTEM: The emergency battery requires a charge minimum of one (1) hour before testing the

IMPORTANT: In order to maintain proper operation and warranty coverage, the battery must be recharged once per year prior to installation.

Fulham Head Quarters:
Fulham Co., Inc
12705 South Van Ness Ave.
Hawthorne, CA 90250

SAVE THESE INSTRUCTIONS

FHSCP-UNV-8W-S-SD



Mechanical Data

Overall Dimensions	
Length	15.913" [404.2mm]
Width	1.181" [30mm]
Height	1.079" [27.4mm]

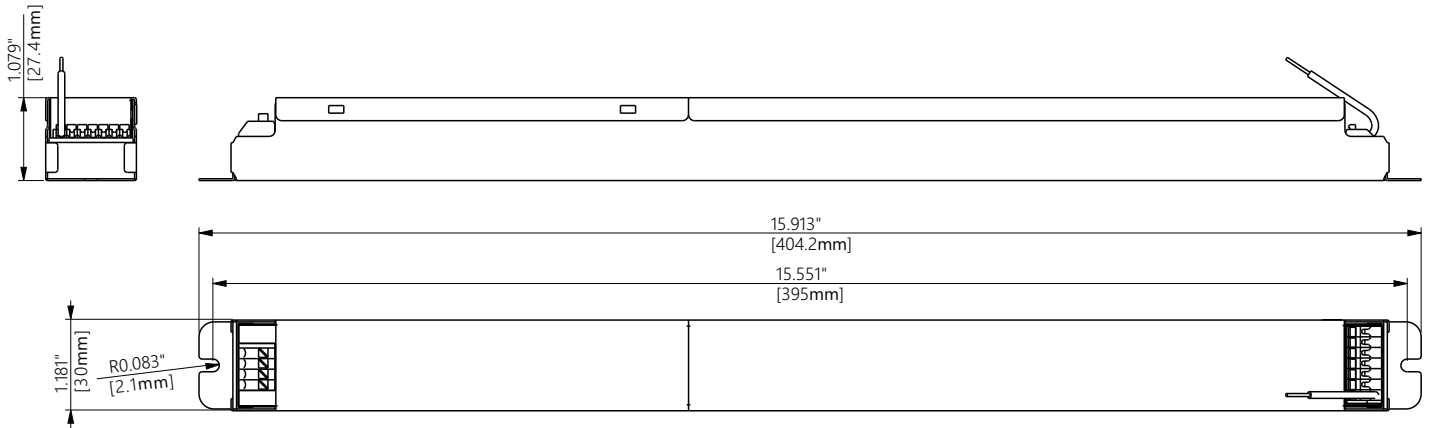

FHSCP-UNV-8W-S-SD



Wiring Diagram

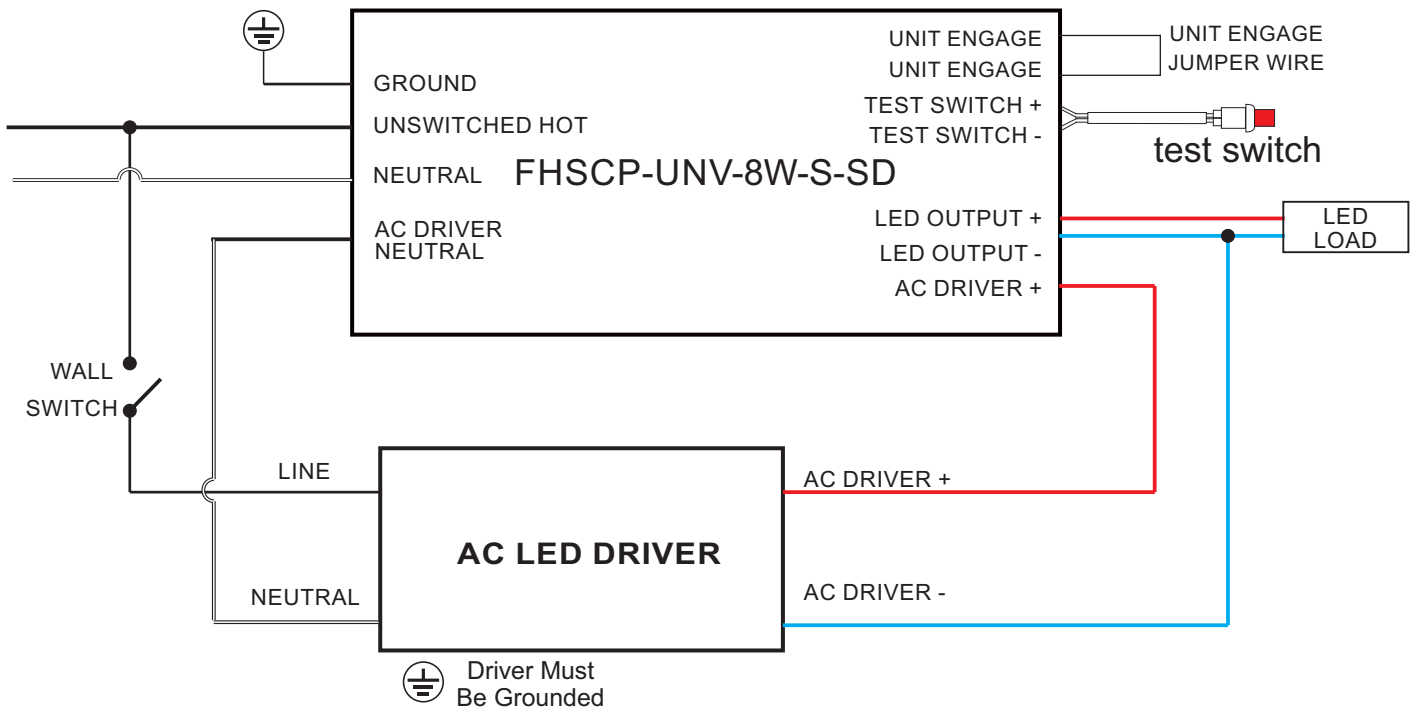

Guideline on calculating emergency illumination level

The purpose of this guideline is to identify the illumination level of the LED luminaire when used with Fulham's FHSCP-UNV-8W-S-SD LED emergency driver. The path of egress illumination level during emergency operation is determined by types of luminaires, Luminaire Efficacy, Luminaire Mounting Height, Emergency Power and some other effects in real application.

Step 1: Select an LED Luminaire, and make sure the LED light source is electrically compatible with Fulham's LED emergency driver. Get the Light Distribution data (usually an .ies file) and Rated Efficacy data (lumen per watt) from luminaire supplier.

If the luminaire is Design Lights Consortium TM (DLC) compliant, you can also get the efficacy information from DLC website.

- Open DLC Qualified Product List(QPL) database search page: <https://www.designlights.org/search/>
- Searching keywords by model, brand name or manufacturer for the luminaire used.
- Find the "Efficacy" data listed on website or calculated by dividing "Light output" by "Wattage", the efficacy value should be shown in lumen per watt (lm/W).

If the luminaire is ENERGY STAR compliant, you can also get the luminaire efficacy information from ENERGY STAR website.

- Open ENERGY STAR certified Light Fixtures database search page: <https://www.energystar.gov/productfinder/product/certified-light-fixtures/results>
- Searching keywords by model, brand name or manufacturer for the luminaire used.
- Find the "Energy Efficiency" data listed on website. If it is showed as "Measured at the Source", please contact with luminaire supplier for additional light loss for this light source inside the fixture. The value should be shown in lumen per watt (lm/W).

Step 2: Determine the Emergency Power and calculate the Emergency Light Output.

Emergency Light Output is equal to the Emergency Power multiply by luminaire efficacy. For example, if the luminaire is 120lm/W and in 8W emergency operation, the total Emergency Light Output is 120lm/W*8W = 960lm.

Step 3: Use industry lighting design software to calculate the illumination level according to the luminaire layout in room, luminaire mounting height, the original .ies file and Emergency Light Output calculated above. If the illumination level cannot meet life safety codes, go back to Step 2 to use a higher Emergency Power or go back to Step1 to select a higher efficacy luminaire or use more luminaires in the room.

Fulham's FHSCP-UNV-8W-S-SD LED emergency driver is compliant with UL924 standard, according to UL test data, Table 1 below give basic indication to determine the min. Emergency Power and Luminaire Max. Mounting Height for 1 foot-candle illumination based on a single luminaire with typical Lambertian distribution. It is the light designer / construction contractor's responsibility to validate the real illumination level on site, to assure the emergency light illumination level is in accordance with the requirement of Federal, state and local municipal codes. It may differ from the theoretical calculations or simulations on a computer.

Table 1. Max. Mounting Height vs. Luminaire Efficacy

Luminaire Efficacy (lm/W)	Max. Mounting Height for 1fc
	EM 10W
80	15.73 ft
100	17.58 ft
120	19.26 ft
140	20.80 ft
160	22.24 ft
180	23.59 ft

FHSCP-UNV-8W-S-SD



SELF-DIAGNOSTIC INSTRUCTIONS / OPERATION:

If the self-diagnostic feature is enabled:











The emergency LED driver will conduct a self-check for sixty(60) seconds every thirty(30) days; and a ninety(90) minutes self-check every 12 months. After every self-check the LED indicator light will indicate a status signal. Check indicator status chart below to diagnose the status signal.

If the self-diagnostic feature is disabled:

User must conduct a manual test every thirty (30) days to ensure the emergency LED light source illuminates as intended. A full discharge test shall be conducted once a year; the LED light source shall illuminate for a minimum of ninety (90) minutes.

***Self-Diagnostic feature is factory enabled**

TEST SWITCH INDICATOR STATUS:

LED Indicators Status	EM Driver Status / Mode
 Solid Green	System OK / AC OK (Self-Diagnostic Enabled or Disabled)
 Slow Flashing Red, 4s on / 1s off	Battery NOT detected, check battery switch or connection
 Flashing Red, 1s on / 1s off	Battery Failure, replace battery
 Flashing Green, 1s on / 1s off	Self-Diagnostic test underway
 Slow Flashing Green, 0.1s on / 3s off	Normal working in EM mode
 Solid Red	No load or output over voltage protection triggered , Check LED connection
 Solid Red	Over Current Protection
 Flashing Green, 2s on / 0.5s off	Enables Self-diagnosis
 Flashing Green, 0.5s on / 2s off	Cancel Self-diagnosis
 Flashing Red, 0.5s on / 3s off	Self-diagnose process current fault / The battery voltage is abnormal

TEST SWITCH OPERATIONS

EM Test:

Press and hold the test button (>1s) to enter EM mode in normal AC powered.

Manual Self-Diagnostic:

After charging twelve (12) hours or battery fully charged, quickly press the test button three(3) times to force the controller to enter Self-Diagnostic cycle. To quit the Self-Diagnostic cycle after engaged, press and hold the test button for three (3) seconds.

Query Self-Diagnostic Status:

Fast click 2 times within 2s to query the Self-Diagnostic status. The indicator would blink for current status for 3 cycles. 2s ON / 0.5s OFF stands for Enabled. 0.5s ON / 2s OFF stands for Disabled.

How to Enable and Disable Self-Diagnostic Status:

Press and hold the test button for one second, then release, and press and hold the test button for 2 seconds.

Emergency Battery Disconnect:

Press and hold the test switch for 5 seconds during EM output condition to turn off EM output. This is useful for production environment to turn off the EM output once a luminaire has completed functionality testing.

DO NOT USE IF PRODUCT AND ITS USE DO NOT COMPLY WITH THE ABOVE