

LUXRITE®

LED CANLESS - SPOTLIGHT



4"



*TRIMS SOLD SEPARATELY

2 HOUR FIRE RATING
TESTED TO COMPLY WITH UL 263
ASTM E119 & CAN ULC S101



FRONT VIEW



LR24910
LED/DLMD4/FIRE/5CCT/D



LR24911
LED/DLMD4/FIRE/5CCT/D/WFL



APERTURE	4"
DISTRIBUTION	FIXED/WALL WASH
APPLICATION	NEW CONSTRUCTION & REMODEL

ELECTRICAL

POWER	15W
INPUT VOLTS	120V
INPUT CURRENT	0.125A
FREQUENCY	60Hz
DIMMING TYPE	TRIAC/ELV
DIMMING RANGE	10/100%
FEED WIRE GAUGE	18AWG
BREAKER SPECIFICATION *(15A @120V)	79pcs*

*Mathematically estimated value. Actual capacity may vary by breaker type and installation environment.

PHOTOMETRIC

COLOR CCT	2700K/3000K/3500K/4000K/5000K
CRI	90
LUMEN	1000lm
EFFICACY	87lm/w
BEAM ANGLE	LR24910: 38°
	LR24911: 60°

CERTIFICATIONS & SAFETY

LR24910	ETL, TITLE 24, ENERGY STAR
LR24911	ETL, TITLE 24, ENERGY STAR
IP RATING	IP-54
WET LOCATION	WET LOCATION
IC RATED	YES
AIR TIGHT	YES
OPERATING TEMP.	-4°F to 104°F
COST/YR	\$ 1.80
WARRANTY	5 YR

MATERIAL & APPLICATION

HOUSING	IRON
HEAT SINK	ALUMINUM
TRIM	ALUMINUM
LENS	PC ACRYLIC
CUTOUT	Ø3.75"
MOUNTING TYPE	RECESSED
AREA OF APPLICATION	RESIDENTIAL, COMMERCIAL
CEILING TYPE	DRYWALL, WOOD

DRIVER

MODEL	DESCRIPTION	POWER	INPUT VOLTS	INPUT CURRENT	FREQUENCY	INPUT POWER	OUTPUT VOLTAGE	DIMENSIONS	KNOCKOUTS
INCLUDED		15	120V	0.125A	50/60Hz	12W max	170V DC	5.43"L X 3.3"W X 1.33"H	4
LR24969*	LED/DLMD4/DRIVER/UNV/0-10V	15	120-277V	100mA	50/60Hz	12W max	170V DC	5.11"L X 2.32"W X 1.45"H	4

MODEL	DESCRIPTION	EM POWER	INPUT VOLTS	INPUT CURRENT	FREQUENCY	INPUT POWER	OUTPUT VOLTAGE	RECHARGE TIME	EMERGENCY TIME
LR35126**	LED/EMR/15W/AC/SF/E	15	100-347V	100mA	50/60Hz	12W max	170V DC	24HR	90MINS

*AMBIENT TEMPERATURE: 41°F ~ 122°F
*SOLD SEPARATELY

DIMENSIONS

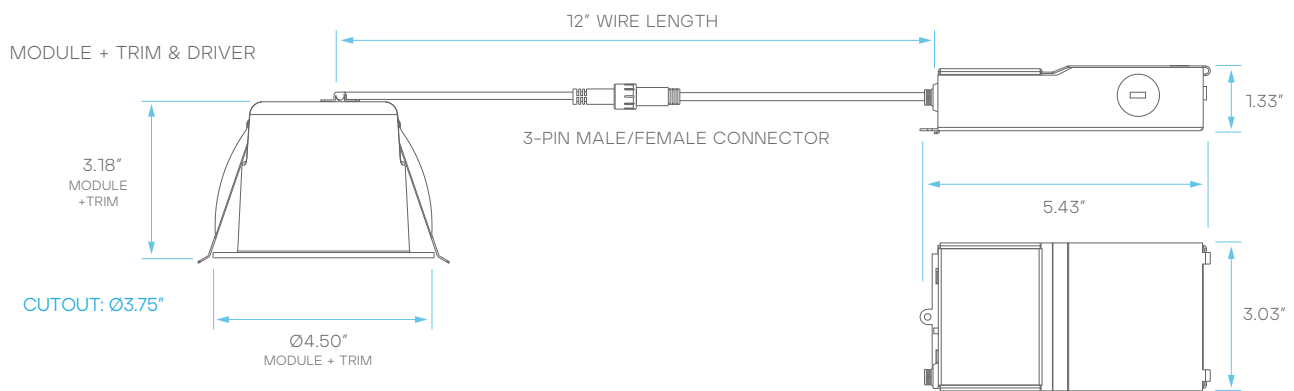
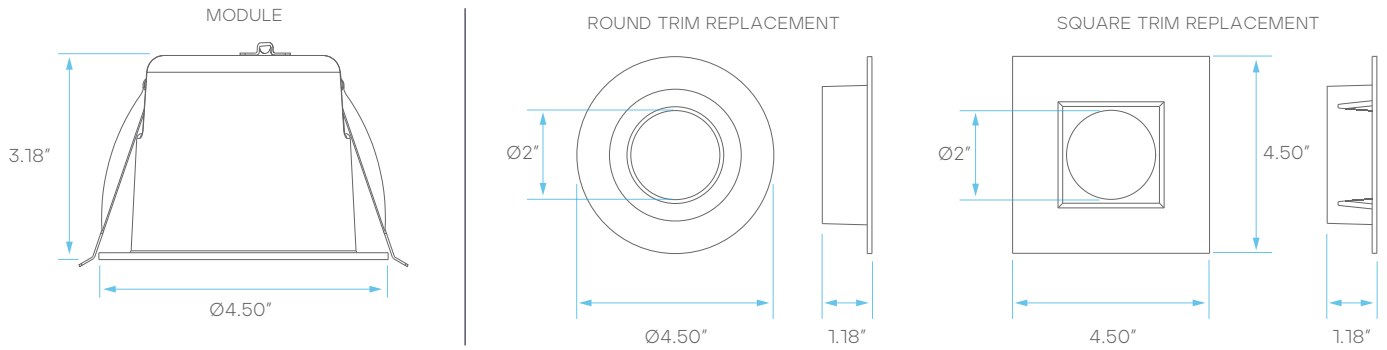
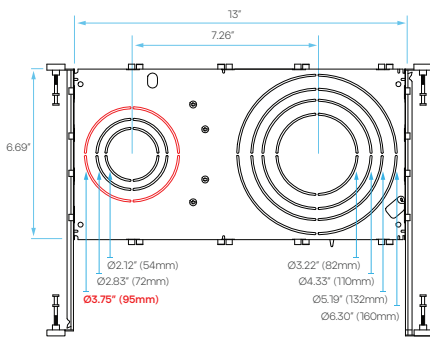

PLATE COMPATIBILITY*

*SOLD SEPARATELY

**LR41010
KNOCKOUT
L2**



**LR41004
KNOCKOUT 2**

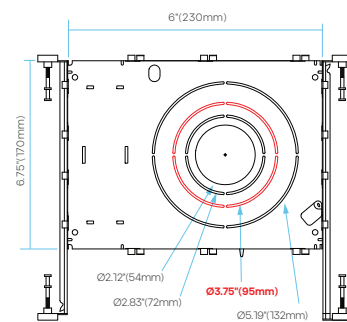

**LR41006
KNOCKOUT
2**

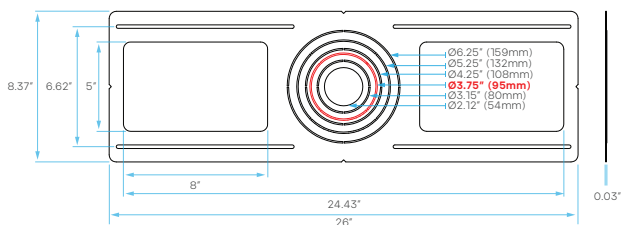



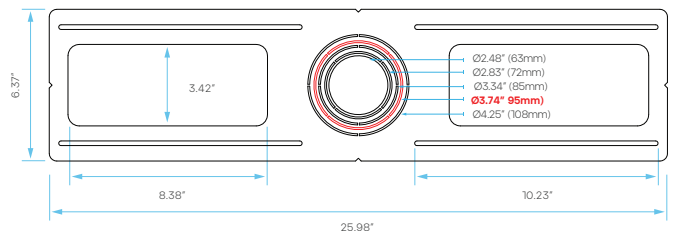









**LR41011
KNOCKOUT 3**



INTERCHANGEABLE TRIM OPTIONS*

*SOLD SEPARATELY

	MODEL	DESCRIPTION	SIZE	FINISH	SHAPE	APPLICATION
	LR24952	LED/DLMD4/TRIM/RD/W	4"	WHITE	ROUND	FIXED
	LR24953	LED/DLMD4/TRIM/RD/B/W	4"	WHITE	ROUND	FIXED
	LR24956	LED/DLMD4/TRIM/RD/BK	4"	BLACK	ROUND	FIXED
	LR24962	LED/DLMD4/TRIM/RD/BN	4"	BRUSHED NICKEL	ROUND	FIXED
	LR24963	LED/DLMD4/TRIM/RD/BZ	4"	BRONZE	ROUND	FIXED
	LR24967	LED/DLMD4/TRIM/RD/BK/WT	4"	BLACK/WHITE	ROUND	FIXED
	LR24954	LED/DLMD4/TRIM/SQ/W	4"	WHITE	SQUARE	FIXED
	LR24955	LED/DLMD4/TRIM/SQ/B/W	4"	WHITE	SQUARE	FIXED
	LR24958	LED/DLMD4/TRIM/SQ/BK	4"	BLACK	SQUARE	FIXED
	LR24964	LED/DLMD4/TRIM/SQ/BN	4"	BRUSHED NICKEL	SQUARE	FIXED
	LR24965	LED/DLMD4/TRIM/SQ/BZ	4"	BRONZE	SQUARE	FIXED
	LR24968	LED/DLMD4/TRIM/SQ/BK/WT	4"	BLACK/WHITE	SQUARE	FIXED
	LR24978	LED/DLMD4/TRIM/SQ/BRS	4"	BRASS	SQUARE	FIXED

WIRE EXTENDER OPTIONS

*SOLD SEPARATELY



MODEL	TYPE	WIRE GAUGE
LR41051	5' - 3 PIN	22 AWG
LR41053	10' - 3 PIN	22 AWG
LR41055	20' - 3 PIN	22 AWG

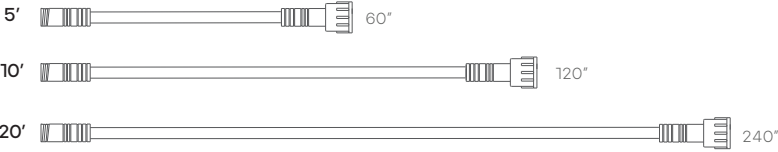

WIRING DIAGRAM

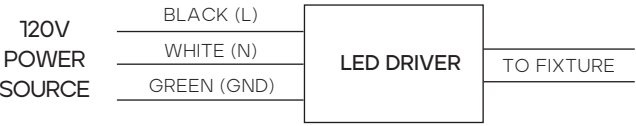

SUGGESTED COMPATIBLE DIMMER*

LUTRON	CTCL-153P
	DVCL-153PDH
LEVITON	DVCL-153P
	6672
PASS & SEYMOUR	6674
	HCL453PTCCCV6

*Dimmer performance may vary based on load, wiring, and installation conditions. Inclusion on this chart does not guarantee compatibility for every installation, and omission does not indicate incompatibility. Refer to the dimmer manufacturer's installation instructions and verify minimum load requirements to avoid field issues

PACKAGING

MODEL	STYLE	INNER BOX DIMENSIONS	MASTER CARTON DIMENSIONS	CASE
LR24910	INNER BOX + MASTER CARTON	6.49" X 5.90" X 3.93"	18.30" X 13.58" X 12.79"	18
LR24911	INNER BOX + MASTER CARTON	6.49" X 5.90" X 3.93"	18.30" X 13.58" X 12.79"	18

LuxiFlow™ PHOTOMETRICS

Luxrite® Luxiflow® tool is for informational purposes only, it is not intended to provide lighting or electrical advise.

LUMINOUS INTENSITY DISTRIBUTION DIAGRAM

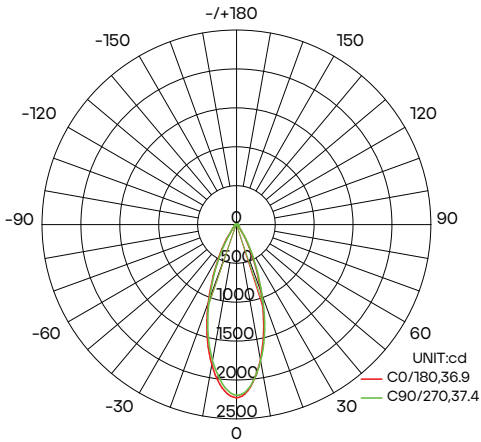

AVERAGE BEAM ANGLE(50%):37.1 DEG

*DIAGRAM SHOWING LR24910 AT 2700K - 15W

CO PLANE ISOLUX DIAGRAM (UNIT:1x)

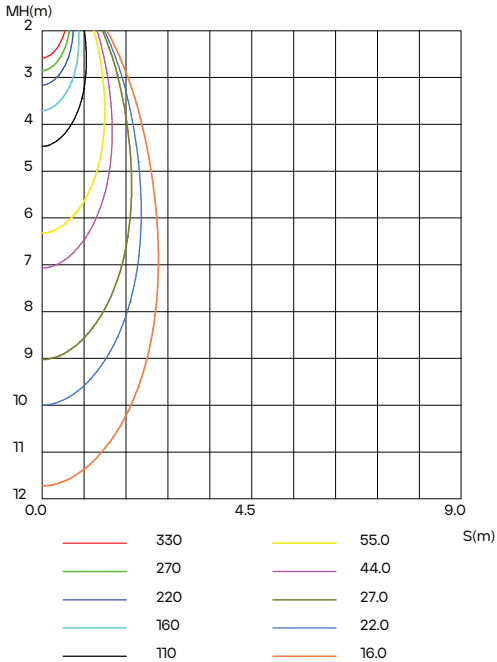

Luxrite® Luxiflow® tool is for informational purposes only, it is not intended to provide lighting or electrical advice.

LUMINOUS INTENSITY DISTRIBUTION DIAGRAM

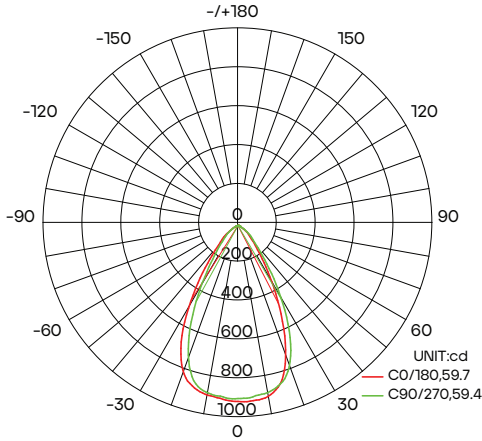

AVERAGE BEAM ANGLE(50%): 59.5 DEG

*DIAGRAM SHOWING LR24911 AT 2700K

C0 PLANE ISOLUX DIAGRAM (UNIT: lx)

