

4" LED BACKLIT PANEL - 3 CCT & 4WATTAGE SELECTABLE LR24220 (4"x2FT), LR24221 (4"x4FT), LR24222(4"x6FT), LR24223 (4"x8FT)

IMPORTANT

- Read instructions carefully before installation.
- Keep these instructions for future reference.
- The backlit LED panels must be wired in accordance with the National Electrical Code and all applicable local codes.
- Proper grounding is required for safety.
- This product must be installed in accordance with the applicable installation code by a qualified electrician who is familiar with the construction and operation of the product and the hazards involved.

INSTALLATION INSTRUCTIONS

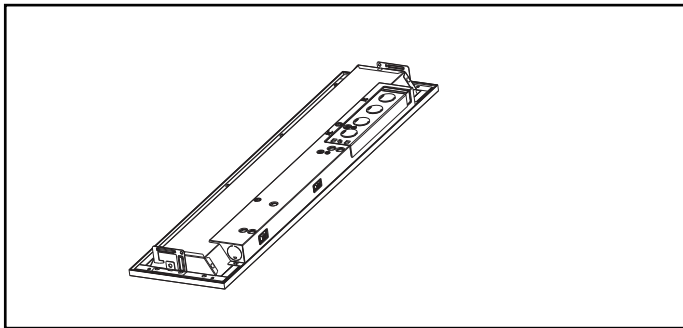

1. CAREFULLY UNPACK THE FIXTURE FROM ITS PACKAGING AND CHECK BOX CONTENTS.

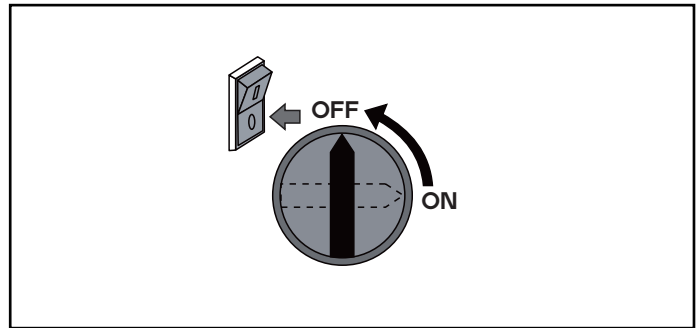

2. TURN OFF POWER AT CIRCUIT BREAKER

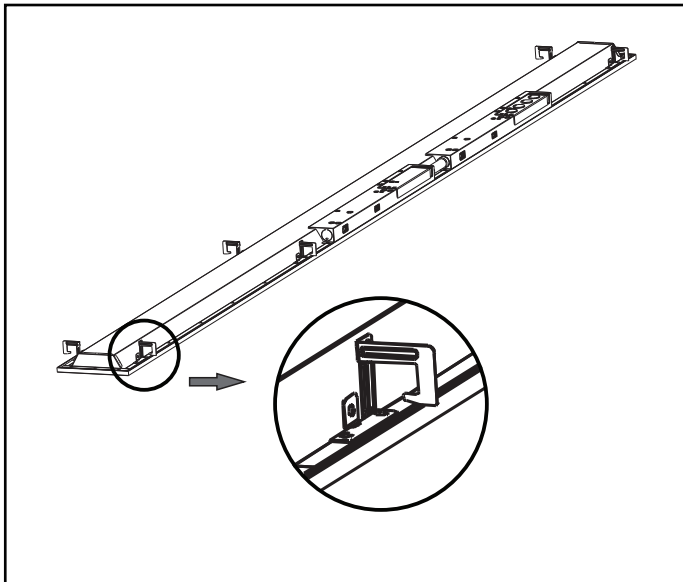

3. LOCATE ALL FOUR EARTQUAKE CLIPS ON THE BACK OF LUMINAIRE. TWIST EACH TAB AWAY FROM LUMINAIRE TESTING THEM ON THE T-BAR.

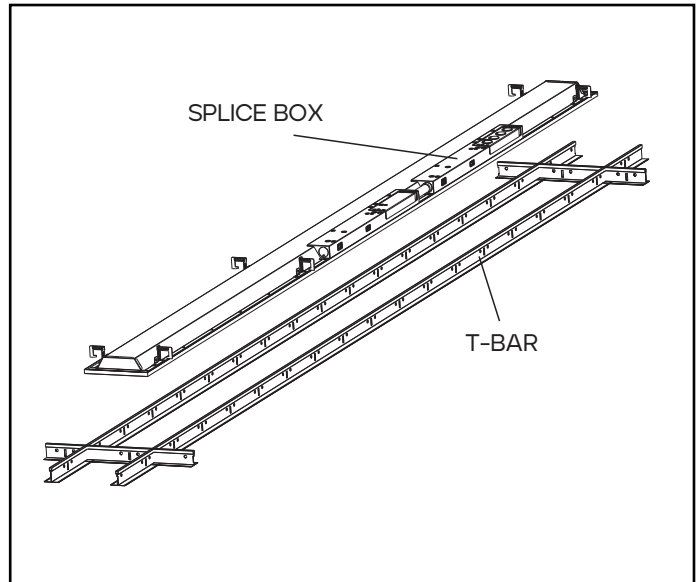

4. REST THE LUMINAIRE ON THE T-BAR OF THE CEILING SUSPENSION SYSTEM IN THE DESIRED LOCATION.

5. OPEN THE CONNECTION BOX AND CONNECT THE INCOMING ELECTRICAL WIRES TO THE SET OF POWER WIRES BLACK TO BLACK (LIVE), WHITE TO WHITE (NEUTRAL) AND GREEN TO GREEN (GROUND). SEE DIAGRAM 1.

6. FOR 0-10V DIMMING, MAKE SURE TO CONNECT THE SAME WIRE COLOR. SEE WIRING DIAGRAM 2.

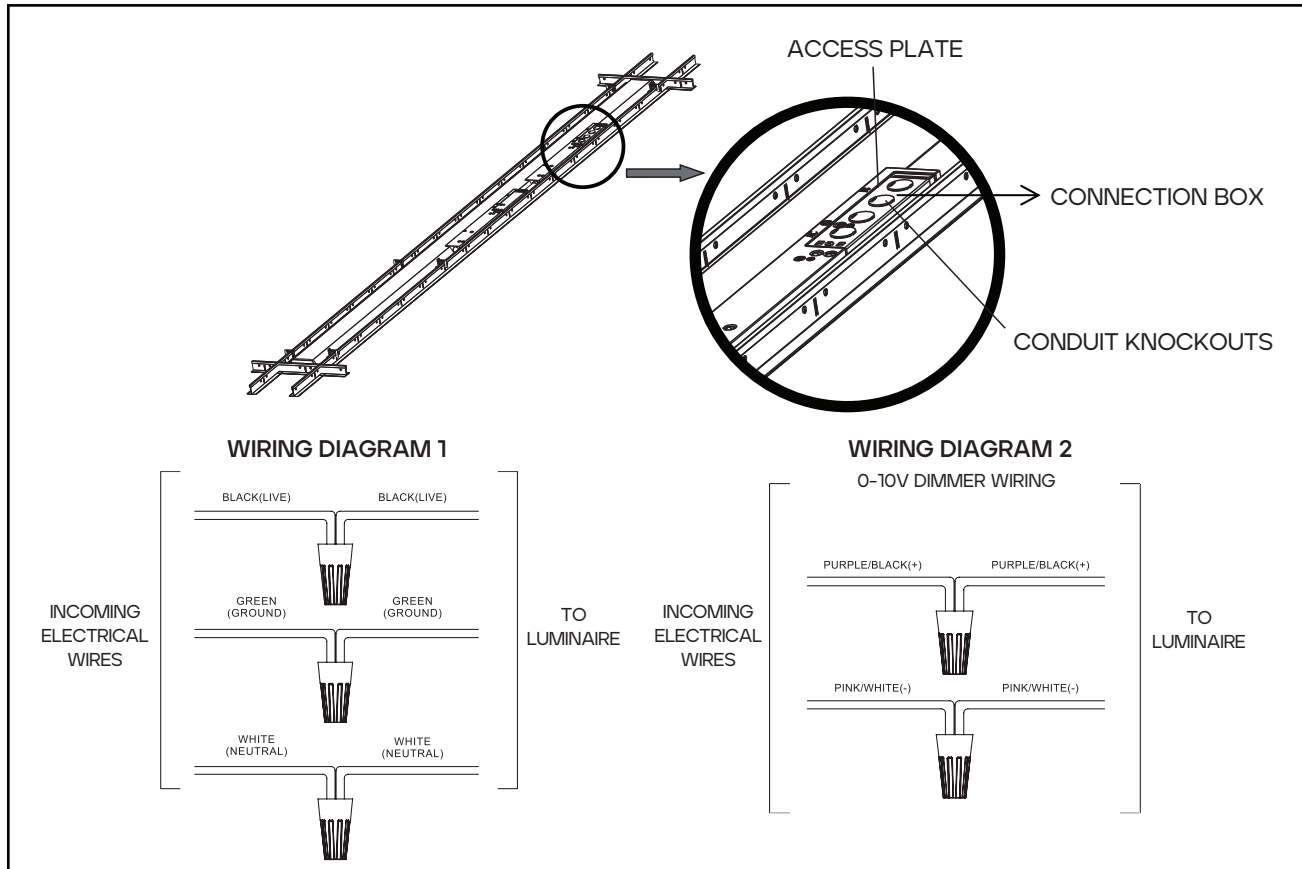

7. CHECK THE WIRING, MAKE SURE EVERYTHING IS CORRECT. RECOVER THE CONNECTION BOX.

8. SELECT THE CCT AND WATTAGE YOU NEED.

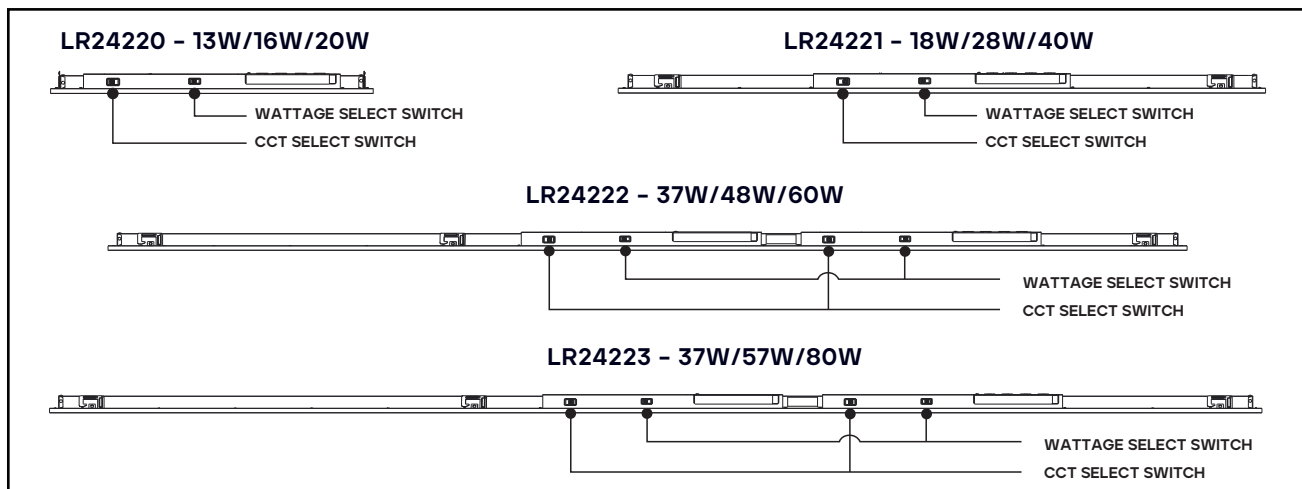

9. TURN ON POWER TO LIGHT UP THE LUMINAIRE.