

LED SPOTLIGHT CANLESS RECESSED MINI PANEL 5 CCT + 3 WATTAGE SELECTABLE 2", 4", 6" - UNIVERSAL VOLTAGE



6"

LR23903

11W | 13W | 15W

1000 | 1250 | 1500 | LUMENS

UNIVERSAL VOLTAGE

4"

LR23902

8W | 10W | 12W

675 | 825 | 1100 | LUMENS

UNIVERSAL VOLTAGE

2"

LR23900

6W | 8W | 10W

500 | 700 | 900 | LUMENS

120V



COLOR SELECTABLE

2700K | 3000K | 3500K | 4000K | 5000K

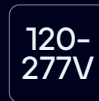





ELECTRICAL

MODEL	DESCRIPTION	POWER	LUMEN	EFFICACY	INPUT VOLTS	DIMMABLE	LIFETIME
2" LR23900	LED/MINI2/PANEL/3WO/5CCT/RD/B	6	500	87	120V	TRIAC	50,000
		8	700	88			
		10	900	90			
4" LR23902	LED/MINI4/PANEL/3WO/5CCT/RD/UNV/B	8	675	84	120-277V	TRIAC	50,000
		10	825	83			
		12	1100	92			
6" LR23903	LED/MINI6/PANEL/3WO/5CCT/RD/UNV/B	11	1000	91	120-277V	TRIAC	50,000
		13	1250	96			
		15	1500	100			

PHOTOMETRIC

MODEL	DESCRIPTION	COLOR (CCT)	TEMP	FLOOD*	CRI	UL	PLATE (KNOCKOUT)
LR23900	LED/MINI2/PANEL/3WO/5CCT/RD/B	2700K/3000K/3500K/4000K/5000K	CCT SELECT	110°	90	YES	LR41002 (#0) LR41006 (#1) LR41010 (R0)
LR23902	LED/MINI4/PANEL/3WO/5CCT/RD/UNV/B	2700K/3000K/3500K/4000K/5000K	CCT SELECT	110°	90	YES	LR41002 (#1) LR41006 (#3) LR41010 (R1) LR41011 (#4)
LR23903	LED/MINI6/PANEL/3WO/5CCT/RD/UNV/B	2700K/3000K/3500K/4000K/5000K	CCT SELECT	110°	90	YES	LR41002 (#2) LR41006 (#5) LR41010 (R3)

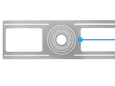
COMPATIBILITY

LR35126 Emergency LED Driver 	LR41002 New Construction Mounting Plate 	LR41006 New Construction Mounting Plate 
LR41010 New Construction Mounting Plate 	LR41011 New Construction Mounting Plate 	

KNOCKOUTS

Model	Knockout #	Knockout Size
LR41002	#0	Ø3.14" (Ø80 mm)
	#1	Ø4.33" (Ø110 mm)
	#2	Ø6.29" (Ø160 mm)
LR41006	#0	Ø2.12" (Ø54 mm)
	#1	Ø3.15" (Ø80 mm)
	#2	Ø3.75" (Ø95 mm)
	#3	Ø4.25" (Ø108 mm)
	#4	Ø5.25" (Ø132 mm)
LR41010	#L0	Ø2.12" (Ø54 mm)
	#L1	Ø2.83" (Ø72 mm)
	#L2	Ø3.75" (Ø95 mm)
LR41011	#R0	Ø3.25" (Ø82 mm)
	#R1	Ø4.33" (Ø110 mm)
	#R2	Ø5.25" (Ø132 mm)
	#R3	Ø6.25" (Ø160 mm)

DIMENSIONS

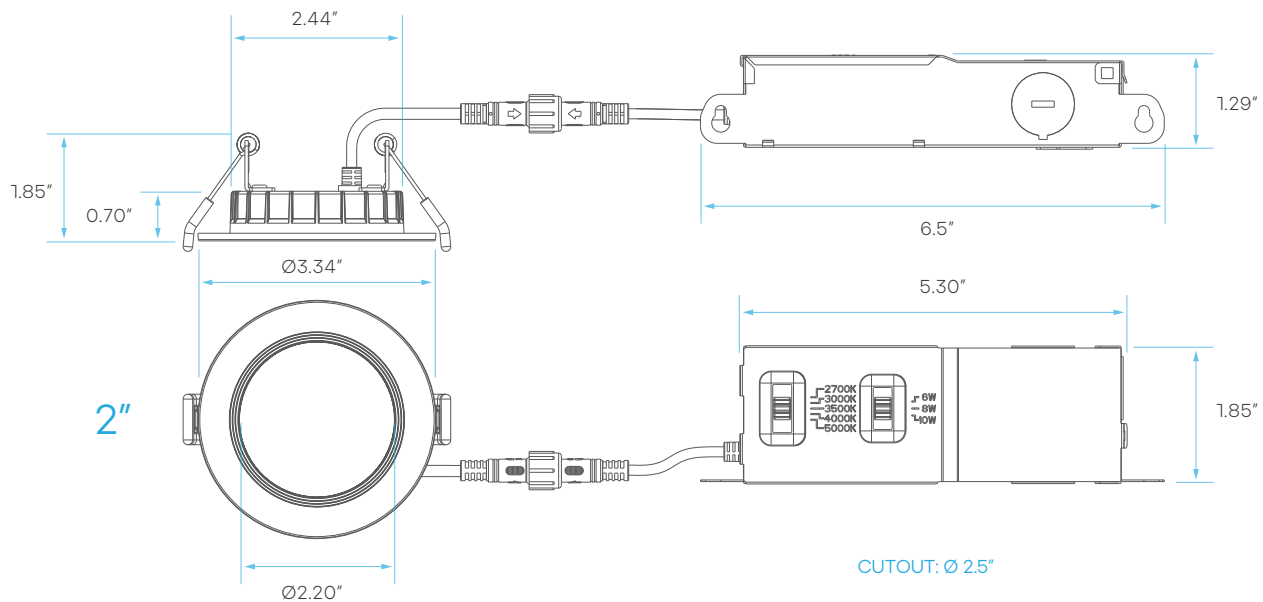

DIMENSIONS

