



The Advance Xitanium DALI LED drivers provide OEMs with flexibility in designing luminaires used in DALI networks. Enabled with SimpleSet technology, these drivers offer the needed performance for the application with precise tuning of drive currents and selectable dimming curves. With wide operating windows, slim profile and simple current adjustability, the drivers make it easy for luminaire manufacturers to design linear fixtures with desired lumen levels to suit the application.

### Specifications

Input Voltage (Vrms)	Output Power (W)	Output Voltage (V)	Output Current (A)	Efficiency @ Max. Load	Max. Case Temp. (°C)	Input Current (Arms)	Max. Input Power (W)	Inrush Current (A <sub>pk</sub> /10%- $\mu$ s)	THD @ Max. Load	Power Factor @ Max. Load	Surge Protection Common/Diff (KV)	Weight (Lbs/kgs)	Envir. Protection Rating
120	40	27 ~ 54	0.10 – 1.1	>85%	Life 75 °C UL 85 °C	0.40	47	22/191	<10%	>0.95	2.5/2.5	0.70/0.32	UL Dry & Damp
277				0.17		52/183		<15%					

### Enclosure

	In. (mm)
Case Length	14.17 (360)
Case Width	1.18 (30)
Case Height	1.0 (25.4)
Mounting Length	13.78 (350)
Overall Length	14.17 (360)

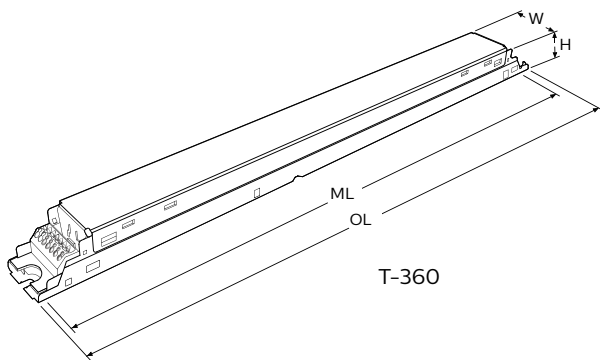

### Wiring Diagram

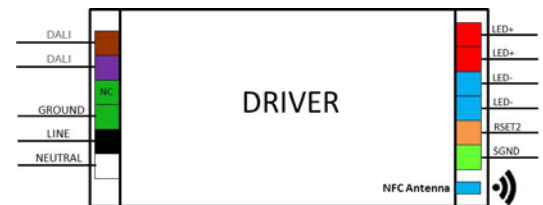

Both output positive and negative connectors are equivalent (same electrical point).

Input and output use WAGO 250 connectors.

### Connect Wires

Use 18 AWG solid copper wire.  
Rated  $\geq$  300V.  
Strip Wire 3/8".

Dimming Method	Dimming Range	Minimum Output Current (A)
DALI	5% ~ 100% (for output current range 0.25-1.1A)	0.0125



LED class 2 output  
For Dry and Damp Location

Class P  
Conforms to UL STD 8750  
Certified to CAN/CSA STD  
C22.2 No. 250.3

# Xitanium DALI XI040C110V054YPT2

## 40W 0.10-1.1A 54V DALI

### Features

- Suitable for use in DALI networks
- SimpleSet programming for wireless drive current setting
- Large operating window
- Dim-to-off capability
- 50,000 hour lifetime<sup>1</sup>
- Drive current setting via SimpleSet wireless programming or Rset2
- 5-year limited warranty<sup>2</sup>

### Benefits

- Enable interoperability with DALI networks
- Slim profile housing enables easy design-in with excellent thermal performance
- Enables fixture design-in with wide application coverage for various load and lumen levels

### Application

- Indoor linear applications such as troffers and pendants

### Product Data

All specifications are typical and at 25°C Tcase unless otherwise specified.

#### Ordering Information

Order Code	XI040C110V054YPT2
Full Product Code	XI040C110V054YPT2M (Mid-pack, 18/box)
Full Product Name	XITANIUM 40W 0.10-1.1A 54V 120-277V DALI
Net Weight Per Piece	0.32 KG / 0.70 lbs

#### Input Information

Inrush Current	Per NEMA 410
Line Voltage (AC Operation)	120-277VAC +/- 10%
Line Current	0.40A @ 120V, 0.17A @ 277V
Line Frequency	50/60Hz

#### Output Information

Output Voltage Range	27VDC to 54VDC
Output Current Ripple	<15% at max lout (ripple = pk-avg/avg) Low frequency (<120 Hz) content <5%
Output Current Tolerance	±5% at max output current
Open Circuit Voltage	60V
Protections	Short Circuit and Open Circuit Protection for LED + and LED-, mis-wiring protection

#### Features

AOC (Adjustable Output Current)	100mA to 1100mA via external resistor or SimpleSet programming (refer to graphs and notes)
Life @ TC 75°C	50000 hr [nom] (refer to graphs)
Suitable for Outdoor Use?	No
Interfaces	AOC (RSET2 or SimpleSet), DALI
Ambient Temp Range	-20°C to +50°C
Max. Case Temperature (Tcase)	85°C for UL, 75°C for life
Input Over-voltage	Can survive input over-voltage stress of 320VAC for 48 hours and 350VAC for 2 hours
Earth Leakage Current	0.75 mA [max]
THD Total	Refer to graph
Power Factor	Refer to graph

#### Environment & Approbation

Agency Approbations	UL8750, UL1310, UL935, CSA-C22.2 No. 250.13-12, CSA C22.2 No. 223
Audible Noise	<24dB Class A
Isolation Between Output and Input	Refer to table
Isolation of Controls	Refer to table
EMC (Electromagnetic Compliance)	Meets FCC 47 Part 15 Class A
Envir. Protection Rating	UL Dry & Damp

1. Advance Xitanium LED drivers are manufactured to engineering standards correlating to a designed and average life expectancy of 50,000 hours of operation at maximum rated case temperature. Minimum 90% survivals based on MTTTF modeling.
2. View limited warranty: <http://www.usa.lighting.philips.com/support/support/warranty>

# Xitanium DALI XI040C110V054YPT2

40W 0.10-1.1A 54V DALI

## Electrical Specifications

All the specifications are typical and at 25°C Tcase unless specified otherwise.

## Adjustable Output Current (AOC) Info

LED current tolerance with variation of Rset2 is within  $\pm 5\%$  of Imax.

Rset (Ohms)	Current (mA)	Rset (Ohms)	Current (mA)
1	100	1800	684
100	100	2000	733
110	106	2200	780
120	111	2400	823
130	116	2700	883
150	125	3000	941
160	130	3300	993
180	138	3600	1042
200	146	3900	1085
220	155	4300	1100
240	166	4700	1100
270	176	>100,000	1100
300	190		
330	204		
360	215		
390	228		
430	245		
470	261		
510	277		
560	300		
620	318		
680	340		
750	368		
820	392		
910	422		
1000	452		
1100	485		
1200	515		
1300	545		
1500	602		
1600	632		

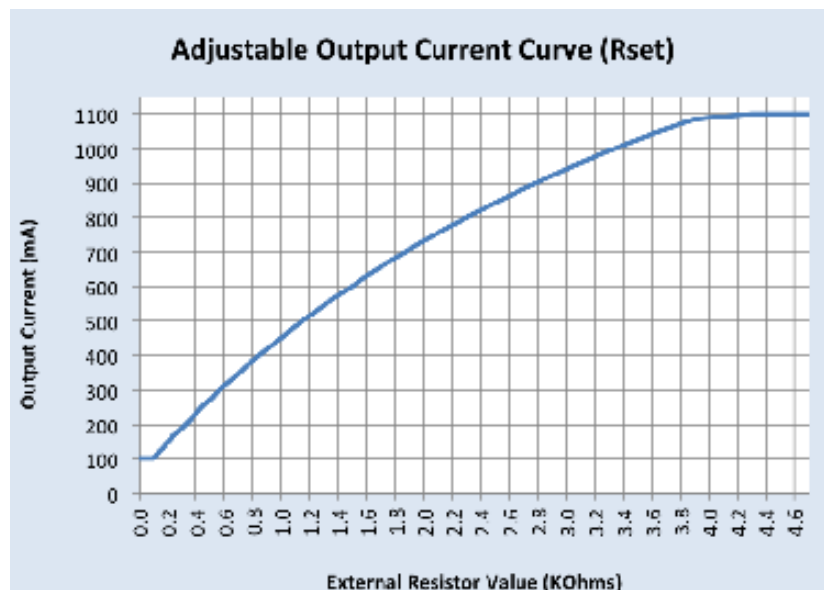

## Notes

- There are two ways to adjust the current:
  - Using a resistor between Rset2 & SGND leads
    - Any through hole or SMD resistor with >0.25W and >20V can be used as RSET between Rset and SGND pins.
    - Driver will default to 1100mA when Rset is left open.
  - Using SimpleSet programming (visit [www.philips.com/simpleset](http://www.philips.com/simpleset) for details)
- The driver is by default set to Rset2.

# Xitanium DALI XI040C110V054YPT2

40W 0.10-1.1A 54V DALI

## Electrical Specifications

All the specifications are typical and at 25°C Tcase unless specified otherwise.

## Operating Window

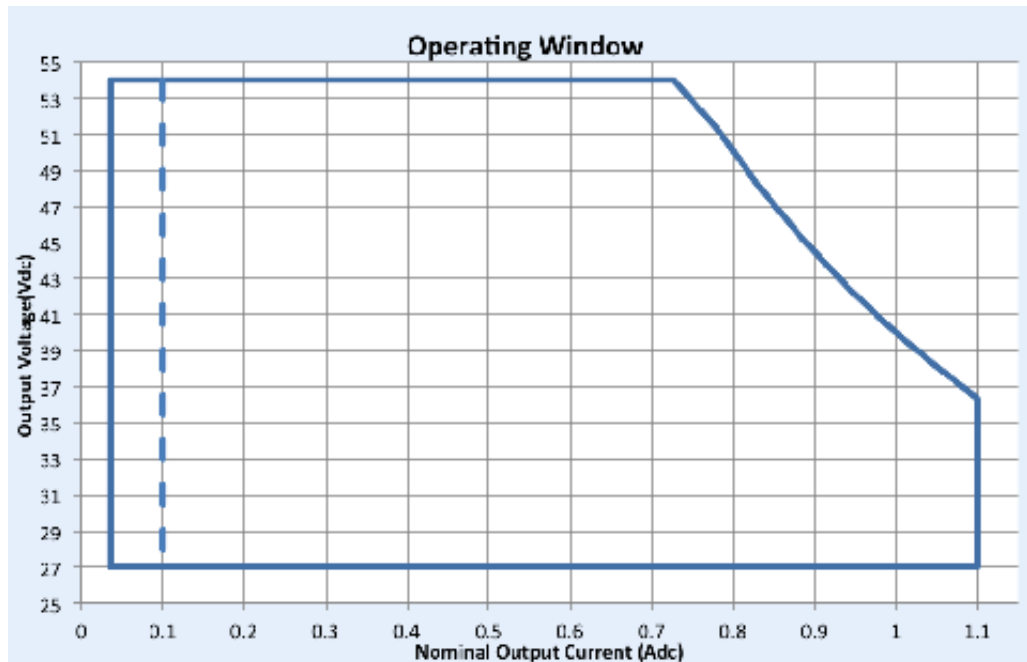

### Note:

For 5% dimming output current setting through AOC should be >0.25A.

# Xitanium DALI XI040C110V054YPT2

40W 0.10-1.1A 54V DALI

## Electrical Specifications

All the specifications are typical and at 25°C Tcase unless specified otherwise.

## Dimming Characteristics

Dimming is accomplished through the 2-wire DALI connection to the sensor. DALI standard IEC62386\_102 Edition 2 defines the logarithmic dimming curve. DALI standard IEC62386\_107 Edition 1 defines the linear dimming curve, as well as the command for switching between logarithmic and linear curves.

### DALI Logarithmic Dimming Curve

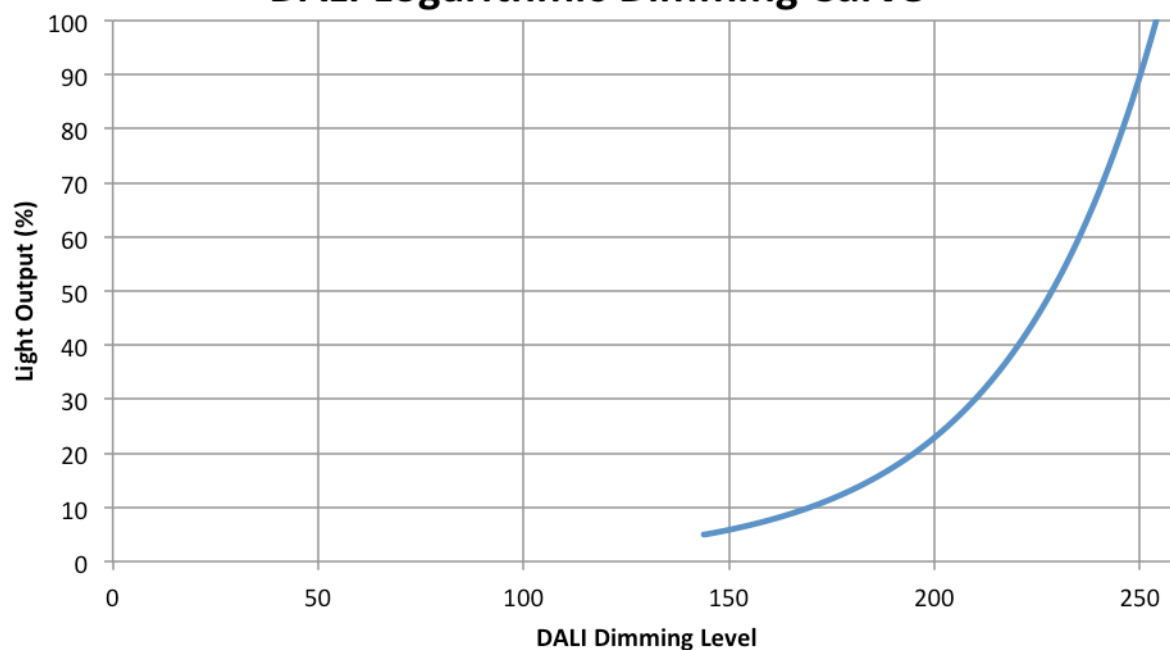

### DALI Linear Dimming Curve

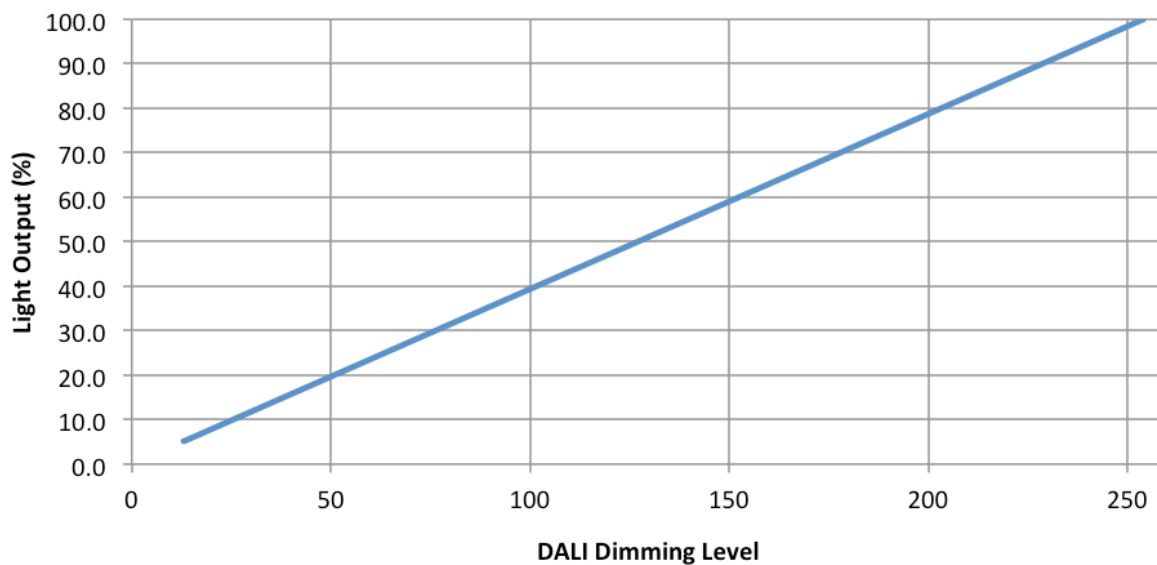

# Xitanium DALI XI040C110V054YPT2

40W 0.10-1.1A 54V DALI

## Performance Characteristics

Based on measurements on a typical sample. The accuracy of the measurements is within the tolerance of the measurement instruments. The graphs are meant to be a guideline and not a specification.

### Power Factor Vs. Output Power

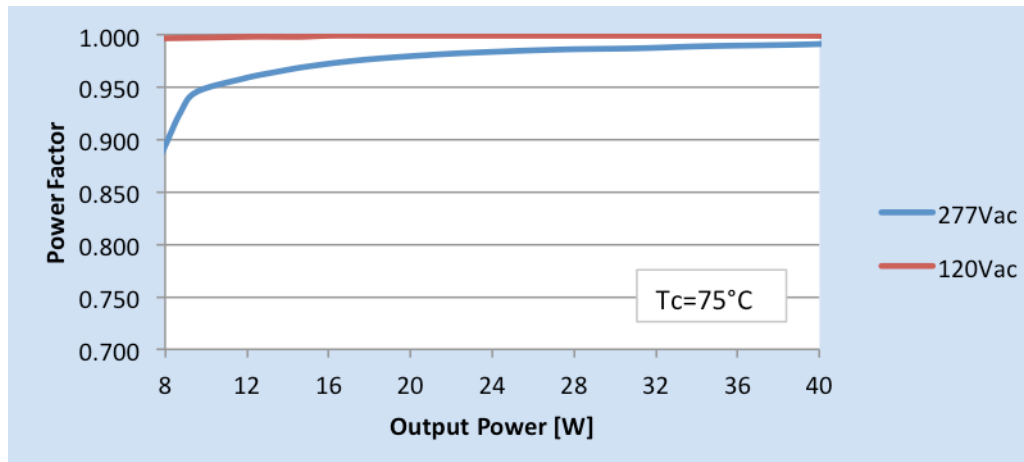

### Total Harmonic Distortion Vs. Output Power

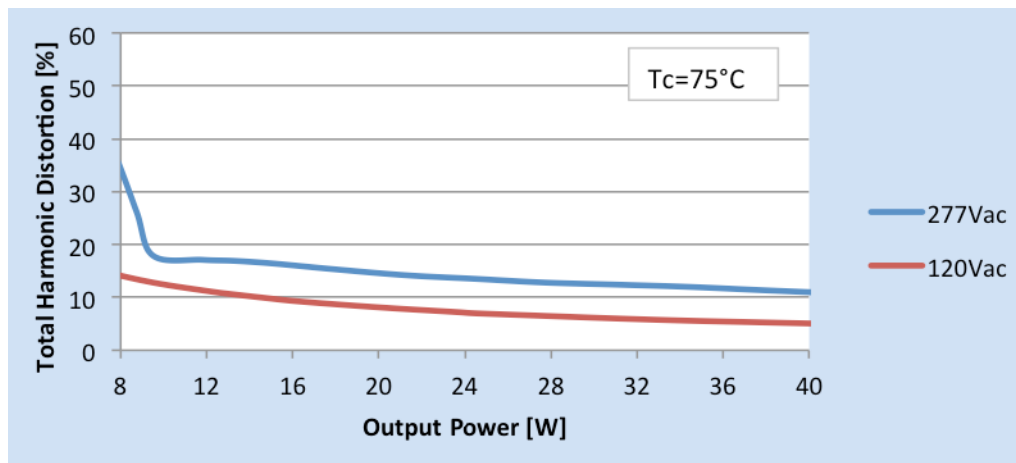

# Xitanium DALI XI040C110V054YPT2

40W 0.10-1.1A 54V DALI

## Performance Characteristics

Based on measurements on a typical sample. The accuracy of the measurements is within the tolerance of the measurement instruments. The graphs are meant to be a guideline and not a specification.

### Output Current Vs. Driver Case Temperature

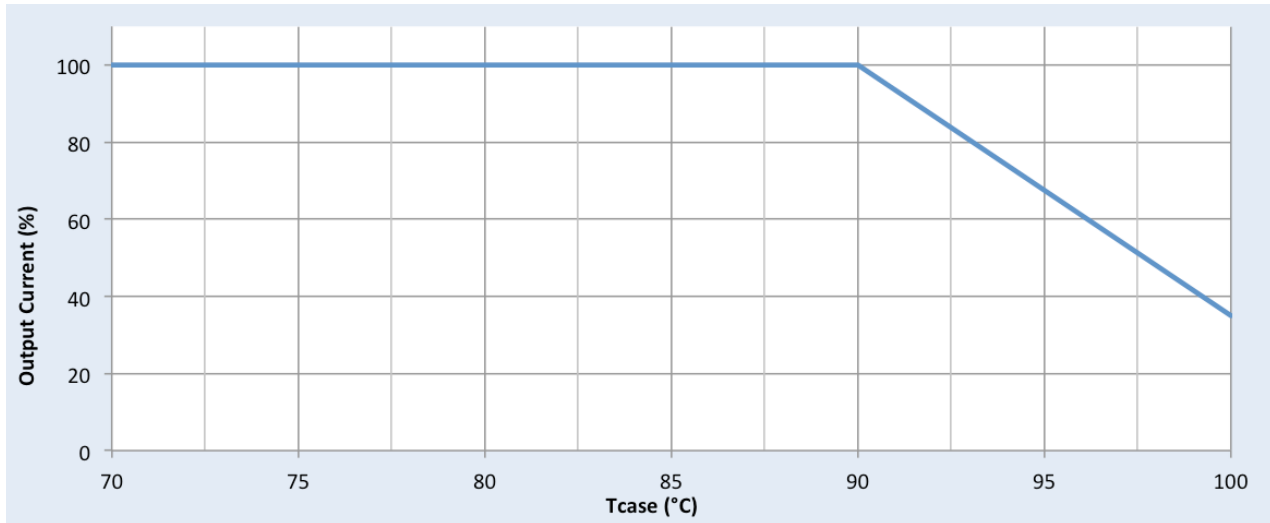

### Lifetime Vs. Tcase of Driver

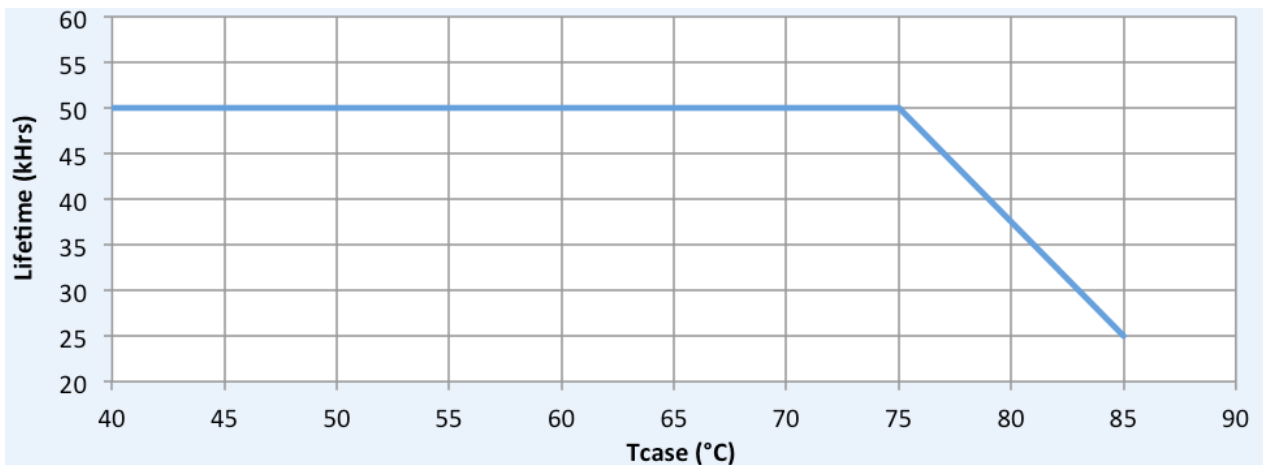

# Xitanium DALI XI040C110V054YPT2

40W 0.10–1.1A 54V DALI

## Performance Characteristics

Based on measurements on a typical sample. The accuracy of the measurements is within the tolerance of the measurement instruments. The graphs are meant to be a guideline and not a specification.

### Performance Plots – Efficiency Vs. Output Voltage (120Vac)

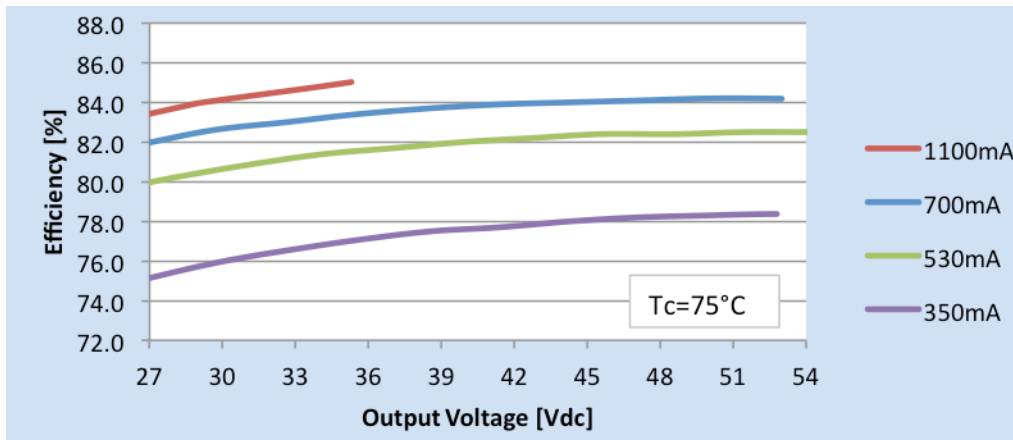

### Performance Plots – Efficiency Vs. Output Voltage (277Vac)

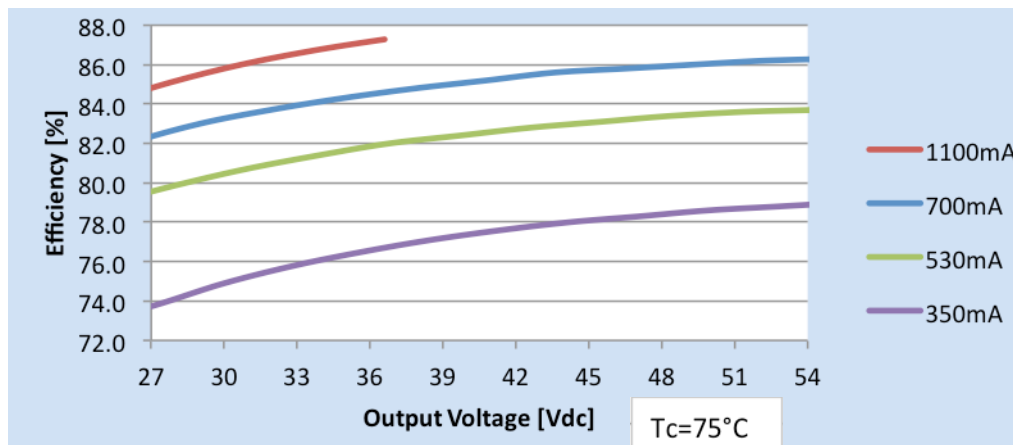



# Xitanium DALI XI040C110V054YPT2

40W 0.10-1.1A 54V DALI

## Inrush Current Info

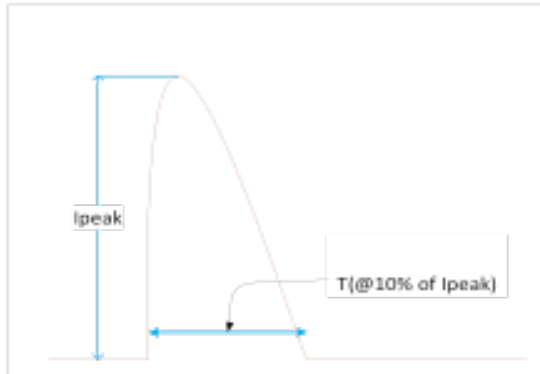

Vin	Ipeak	T (@ 10% of Ipeak)
120 Vrms	22 A	191 μs
277 Vrms	52 A	183 μs

## Lightning Surge Info

ANSI Surge Type	Differential Mode (L-N)	Common Mode (L-G, N-G, L&N-G)
100 kHz Ring Wave (w/t 30Ω)	>2.5kV	>2.5kV

## Isolation

Isolation	Input Connectors	Output + AOC	DALI Connectors	Chassis
Input Connectors	NA	2xU+1kV 1600V	2500V	2xU+1kV 1600V
Output + AOC	2xU+1kV 1600V	NA	500V	500V
DALI Connectors	2500V	500V	NA	500V
Chassis	2xU+1kV 1600V	500V	500V	NA

## Installation & Application Notes

1. LED driver shall be installed inside an electrical enclosure.
2. Wiring inside electrical enclosure shall comply with 300V/90°C rating or higher.
3. Max. number of LEDs in series should not exceed 16.
4. Max. LED voltage should not exceed 54V under all operating conditions.
5. Rset can be used to adjust output current between 100 to 1100 mA for fixed output operation.

† Restrictions on Hazardous Substances (RoHS) is a European directive (2002/95/EC) designed to limit the content of 6 substances [lead, mercury, cadmium, hexavalent chromium, polybrominated biphenyls (PBB), and polybrominated diphenyl ethers (PBDE)] in electrical and electrical products. For products used in North America, compliance with RoHS is voluntary and self-certified.

The information presented in this document is not intended as any commercial offer and does not form part of any quotation or contract.

