

ML50S12AC

Class 2 Magnetic Phase cut Dimmable LED AC Driver

Outdoor Black Powder Coated Steel Enclosure

Single Circuit: **12VAC**

Total Wattage: **50W max**

Input Voltage: **120V 60Hz**



Conforms to UL STD. 1310
Certified to CSA
STD. C22.2 No 223
model EM50
[Link to certification](#)

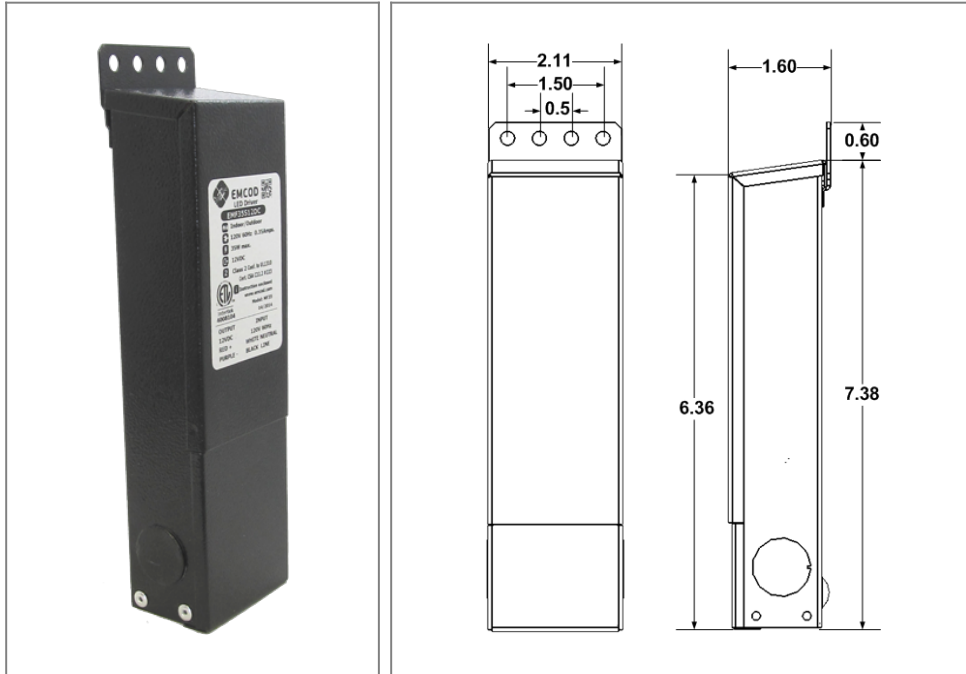

Transformer

Dimmable with compatible MLV, ELV, CL dimmers, please refer to list on emcod.com

Temperature class B(130°C)

Input leads are 18AWG 600V

Output leads are 18AWG 300V

Leads max. operational temperature is 105°C

Thermal self reset primary breaker 1.25A

Thermal self reset secondary breaker 5A

Housing

The actual transformer 50W is encapsulated in the enclosure

The enclosure is Black Powder Coated Steel, NEMA 3R rated

Wiring compartment has 2 knockouts sizes for 3/8 inch screw cable connectors

Enclosure Temperature does not exceed 75°C at 45°C ambient and fully loaded

Dimensions (inch): H = 7, W = 2.11, D = 1.54

Weight (LBs): 2.1

Electrical Parameters

Input Voltage: **120V 60Hz**

Max. input current at full load: **0.4A**

Output voltage without load: **13.2VAC**

Output voltage fully loaded: **11.6VAC**

Max. Total Wattage: **50W**

Max. Output Current: **3.3A**

Efficiency: **85%**

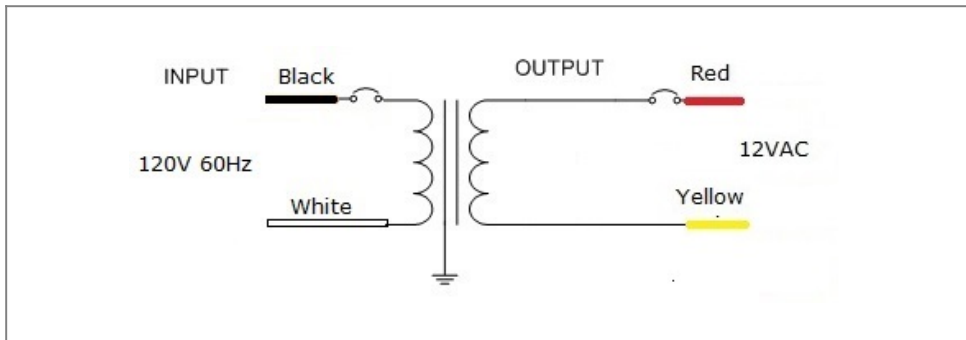

Mailing Address: 6925 Eton Ave. Canoga Park, CA 91303 Tech support: Arik Nirenberg phone: 818-904-3309 cellphone: 818-269-4091
Fax: 818 904 3327 info@emcod.com techsupport@emcod.com