

## COBRA MINI LINEALUCE

Rigid Cove Standard White

formalighting  
COLLECTION



CR2-12

### DESCRIPTION

COBRA Linealuce Mini is a surface mounted modular LED system in extruded aluminum with 90° vertical adjustability in two directions. Offered in 15 lengths, multiple beam spreads and optical accessories. Ideal as indirect cove light applications, to create a wash illumination for wall and other architectonic surface. Integrated magnets for easy installation. Compliments and integrates as a continuous run with COBRA Flex Mini where straight and curved surface runs are combined in design.

### HOUSING

- Anodized extruded aluminum
- Consult factory for custom finishes and lengths

### MOUNTING

- Surface mount with U-clips, magnets or L brackets, included.

### ELECTRICAL/CONTROLS

- 2 to 32 LED lengths, in two led increments at max. 700mA
- Remote class 2 power supply required
- Maximum 32 LED run per 50W driver
- Series shunt bypass ensures remaining LEDs operate if single LED failure

### LISTING

- cULus Listed to UL2108

### LED INFO

- Oslon GW-CSSRM1 SMD LED: 97 CRI: SDCM = 3-step MacAdam Ellipse, Lumen Maintenance: L<sub>70</sub> > 50,000 hrs

PROJECT INFORMATION		
JOB NAME		TYPE
ORDERING CODE		

### ORDERING CODE

SERIES	COBRA	cove light
TYPE	CR2 CR2-L <sup>1</sup>	cobra rigid mini, standard cobra rigid mini, louver
LED	SW	standard white
SIZE	2 4 6 8 10 12 14 16 18 20 22 24 26 28 30	2 LED, 2-9/16", 160 lm delivered 4 LED, 4-15/16", 320 lm delivered 6 LED, 7-1/4", 480 lm delivered 8 LED, 9-5/8", 640 lm delivered 10 LED, 12", 800 lm delivered 12 LED, 14-3/8", 960 lm delivered 14 LED, 16-3/4", 1120 lm delivered 16 LED, 19-1/16", 1280 lm delivered 18 LED, 21-1/2", 1440 lm delivered 20 LED, 23-13/16", 1600 lm delivered 22 LED, 26-3/16", 1760 lm delivered 24 LED, 28-9/16", 1920 lm delivered 26 LED, 30-7/8", 2080 lm delivered 28 LED, 33-1/4", 2240 lm delivered 30 LED, 35-5/8", 2400 lm delivered <small>For additional lumen packages, see last page.</small>
CCT	27K 30K 35K 40K 50K	2700K 3000K 3500K 4000K 5000K (0.96) (1.00) (1.03) (1.08) (1.14)
CRI	97	97 CRI
LENS OPTION	21D 29D 22X47E	21° lens, CBCP 1700 per 4X LED 29° lens, CBCP 1040 per 4X LED 22° x 47° elliptical lens, CBCP 740 per 4X LED
FINISH	BK WH BS GD	black white polished brass gold
MOUNTING OPTIONS	S	surface mount
ACCESSORIES	See page 3 for details.	
DIMMING	See last page for details.	

### ORDERING CODE

Follow the steps to specify your fixture, example:  
COBRA - CR2 - SW - 12 - 27K - 97 - 29D - BK - S

### NOTES

1. Louver not available with honey comb accessory.

### RELATED PRODUCTS



Cobra Flex Mini - Flexible Cove

### Note:

Used as flexible runs for Cobra Mini Linealuce. See Cobra Mini Flex spec sheet

**PROJECT INFORMATION**

JOB NAME		TYPE	
ORDERING CODE			

**POWER TABLE**
**SW (LED)**

COBRA	DELIVERED LUMENS		VOLTAGE	LED POWER	SYSTEM POWER
	CURRENT MA	LUMENS (3000K)	VDC	W (90 CRI)	W (90 CRI)
2 LED	700	160	4	3	5
	500	120	3	2	4
	350	90	3	1	3
4 LED	700	320	7	5	7
	500	240	7	3	5
	350	180	7	2	4
6 LED	700	480	10	7	9
	500	360	10	5	7
	350	270	10	4	6
8 LED	700	640	13	10	12
	500	480	13	7	9
	350	360	13	5	7
10 LED	700	800	16	12	14
	500	600	16	8	10
	350	450	16	6	8
12 LED	700	960	20	14	16
	500	720	20	10	12
	350	540	20	7	9
14 LED	700	1120	23	16	18
	500	840	23	12	14
	350	630	23	8	10
16 LED	700	1280	26	18	20
	500	960	26	13	15
	350	720	26	9	11
18 LED	700	1440	29	21	23
	500	1080	29	18	20
	350	810	29	11	13
20 LED	700	1600	32	23	25
	500	1200	32	18	20
	350	900	32	12	13
22 LED	700	1760	35	25	27
	500	1320	35	18	20
	350	990	35	13	15
24 LED	700	1920	39	28	30
	500	1440	39	20	22
	350	1080	39	14	16
26 LED	700	2080	42	30	32
	500	1560	42	21	23
	350	1170	42	15	17
28 LED	700	2240	45	32	34
	500	1680	45	23	25
	350	1260	45	16	18
30 LED	700	2400	48	37	39
	500	1800	48	24	26
	350	1350	48	17	19

Power Factor ≥ 0.9

**PROJECT INFORMATION**

JOB NAME		TYPE	
ORDERING CODE			

**PRODUCT DIMENSIONS**

**CR2 - STANDARD**

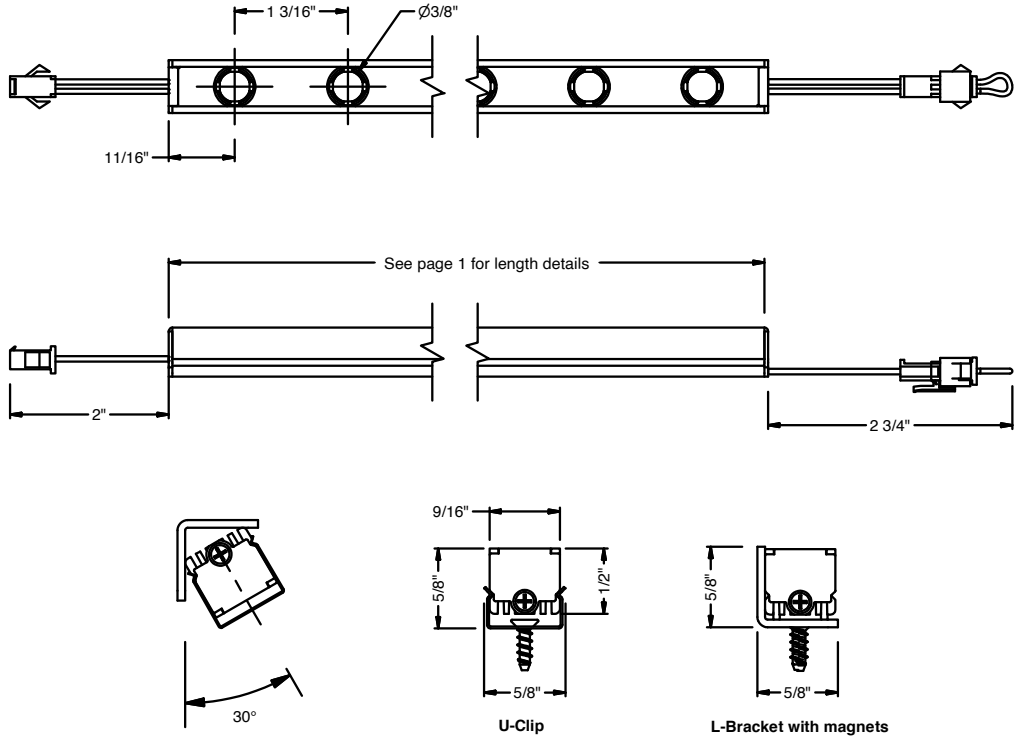

**CR2 - LOUVER**

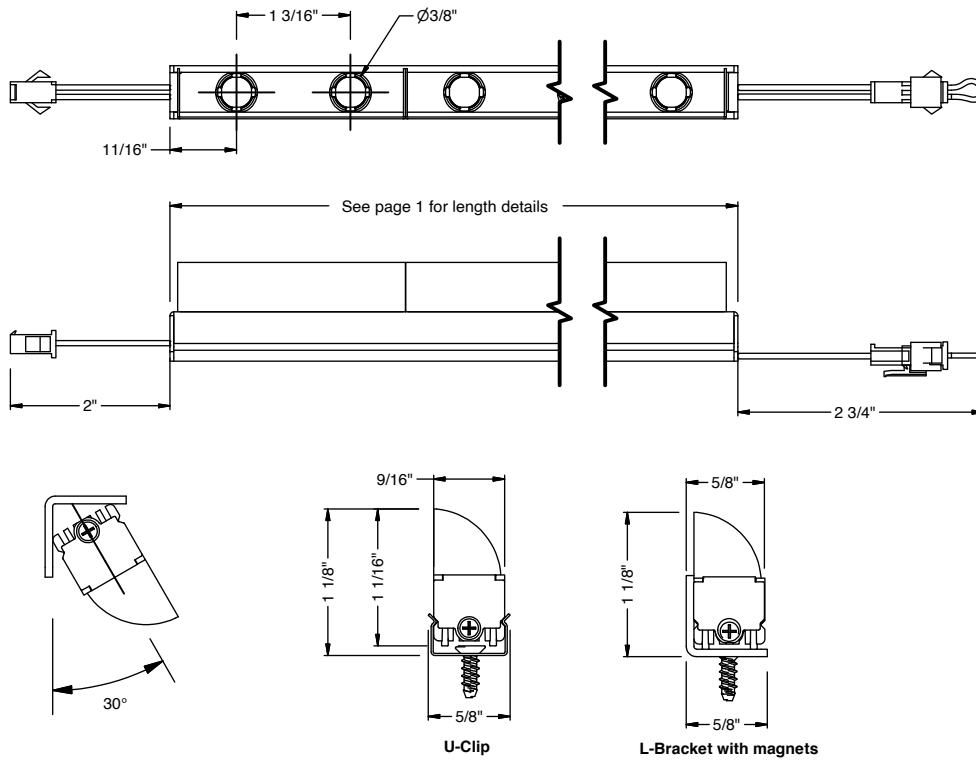

## PROJECT INFORMATION

JOB NAME		TYPE	
ORDERING CODE			

## ACCESSORIES

COBRA-MINI-HCL <sup>3</sup>	honeycomb louver
COBRA-MINI-CF-BL <sup>1,3</sup>	color filter, blue
COBRA-MINI-CF-RD <sup>1,3</sup>	color filter, red
COBRA-MINI-CF-GR <sup>1,3</sup>	color filter, green
COBRA-MINI-CF-AM <sup>1,3</sup>	color filter, amber
COBRA-EXT-HARNESS	39" extension harness, cobra to driver
COBRA-EXT-HARNESS-78	78" extension harness, cobra to driver
COBRA-EXT-HARNESS-157	157" extension harness, cobra to driver
COBRA-DRIVER-HARNESS	12" driver harness, included with driver
COBRA-MINI-UCLIP <sup>2</sup>	mounting U-clip (included)
COBRA-MINI-LBRKT <sup>2</sup>	mounting L-bracket (included)
COBRA-MINI-SCREW <sup>2</sup>	screw for U-clip and L-bracket (included)

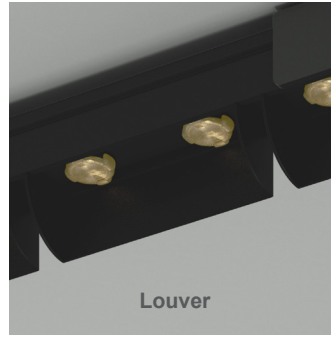

Louver

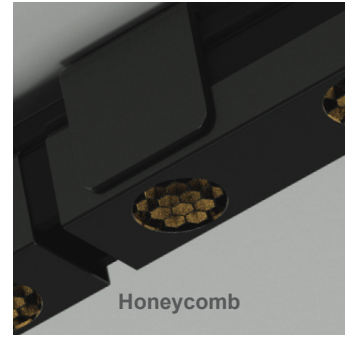

Honeycomb

### NOTES

1. Consult factory for additional color filters.
2. Mounting accessories are only for additional or spare circumstances. All Cobras include adequate quantity of mounting components.
3. 1 accessory per 2 LED's.

## COLOR FILTERS

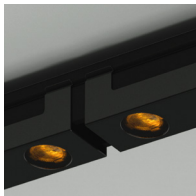

Amber

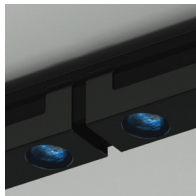

Blue

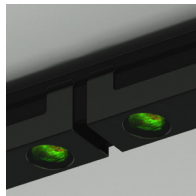

Green



Red

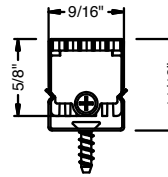

Honeycomb/Color Filter

## REMOTE DRIVER - 0-10V ORDERING CODE

SERIES	P70414-COBRA	LED driver with box and harness
DIMMING	ECO SOLO <sup>1</sup>	1% 0.1%
ELECTRICAL OPTIONS	350 500 700	350mA, 450 lm / ft 500mA, 600 lm / ft 700mA

### ORDERING CODE

Follow the steps to specify your fixture, example:  
P70414 - COBRA - ECO - 700

### NOTES

1. For 2-channel output, cobras must be under 50V/25W each. Order additional driver harness.

### MAXIMUM WIRING DISTANCE FROM DRIVER TO FIRST COBRA AT FULL LOAD

AWG VALUE	DISTANCE (FT)
20	46
18	72
17	92
16	118

## DESCRIPTION

- 0-10V dimmable protocol LED drive with smooth flicker free dimming
- Remote mounting distance up to 46' (20AWG), 72' (18AWG) to LED load
- Three programmable currents for various lumen offerings
- For custom drive currents consult factory

## ELECTRICAL/CONTROLS

- 120-277Vac, 50/60Hz input
- 50W max output
- 2-55Vdc output per channel
- ECO 1% dimming - 1 channel output
- Solo 0.1% dimming - 2 channel output
- 0-10V compatible
- Linear dimming curve
- Operating temperature: -4°F to 122°F
- Class II rated
- Suitable for use in damp and dry locations
- Short circuit protection
- Overload protection
- Over-voltage protection
- Thermal protection
- Box: Length = 9", Width = 4", Height = 1-3/8"
- Driver: Length = 5-1/8", Width = 3", Height = 1-1/8"

PROJECT INFORMATION			
JOB NAME		TYPE	
ORDERING CODE			

## REMOTE DRIVER - DALI ORDERING CODE

<b>SERIES</b>	<b>P70469-COBRA</b>	LED driver with box and harness
<b>DIMMING</b>	<b>DALIZ</b>	eldoLED flicker free DALI dimming to 0%
<b>ELECTRICAL OPTIONS</b>	<b>350</b> <b>500</b> <b>700</b>	350mA, 450 lm / ft 500mA, 600 lm / ft 700mA, 800 lm / ft

ORDERING CODE

Follow the steps to specify your fixture, example:  
**P70469 - COBRA - DALIZ - 700**

MAXIMUM WIRING DISTANCE FROM DRIVER TO FIRST COBRA AT FULL LOAD

AWG VALUE	DISTANCE (FT)
20	46
18	72
17	92
16	118

## DESCRIPTION

- DALI - DT6 dimmable protocol LED drive with smooth flicker free dimming
- Remote mounting distance up to 46' (20AWG), 72' (18AWG) to LED load
- Three programmable currents for various lumen offerings
- For custom drive currents consult factory

## ELECTRICAL/CONTROLS

- 120-277Vac, 50/60Hz input
- 50W max output
- 2-55Vdc output per channel
- DALI compatible
- Linear dimming curve
- Operating temperature: -4°F to 122°F
- Class II rated
- Suitable for use in damp and dry locations
- Short circuit protection
- Overload protection
- Over-voltage protection
- Thermal protection
- Box: Length = 9", Width = 4", Height = 1-3/8"
- Driver: Length = 5-1/8", Width = 3", Height = 1-1/8"

## REMOTE DRIVER - DMX ORDERING CODE

<b>SERIES</b>	<b>P70772-COBRA</b>	LED driver with box and harness
<b>DIMMING</b>	<b>DMXZ</b>	DMX dim to zero
<b>ELECTRICAL OPTIONS</b>	<b>350</b> <b>500</b> <b>700</b>	350mA, 450 lm / ft 500mA, 600 lm / ft 700mA, 800 lm / ft

ORDERING CODE

Follow the steps to specify your fixture, example:  
**P70772 - COBRA - DMXZ - 700**

MAXIMUM WIRING DISTANCE FROM DRIVER TO FIRST COBRA AT FULL LOAD

AWG VALUE	DISTANCE (FT)
20	46
18	72
17	92
16	118

## DESCRIPTION

- DMX dimmable protocol LED drive with smooth flicker free dimming
- Remote mounting distance up to 46' (20AWG), 72' (18AWG) to LED load
- Three programmable currents for various lumen offerings
- For custom drive currents consult factory

## ELECTRICAL/CONTROLS

- 120-277Vac, 50/60Hz input
- 50W max output
- 8-55Vdc output per channel
- Isolated dimming circuit
- DMX compatible
- Operating temperature: -13°F to 122°F
- Class II rated
- Suitable for use in damp and dry locations
- Short circuit protection
- Overload protection
- Over-voltage protection
- Thermal protection
- Box: Length = 9", Width = 4", Height = 1-3/8"
- Driver: Length = 5-1/8", Width = 3", Height = 1-1/8"

## REMOTE DRIVER - CASAMBI ORDERING CODE

<b>SERIES</b>	<b>P70414-COBRA</b>	LED driver with box and harness
<b>DIMMING</b>	<b>CASZ</b>	Casambi Bluetooth control with flicker free - dim to off
<b>ELECTRICAL OPTIONS</b>	<b>350</b> <b>500</b> <b>700</b>	350mA, 450 lm / ft 500mA, 600 lm / ft 700mA, 800 lm / ft

ORDERING CODE

Follow the steps to specify your fixture, example:  
**P70414 - COBRA - CASZ - 700**

MAXIMUM WIRING DISTANCE FROM DRIVER TO FIRST COBRA AT FULL LOAD

AWG VALUE	DISTANCE (FT)
20	46
18	72
17	92
16	118

## DESCRIPTION

- Casambi dimmable protocol LED drive with smooth flicker free dimming
- Remote mounting distance up to 46' (20AWG), 72' (18AWG) to LED load
- Three programmable currents for various lumen offerings
- For custom drive currents consult factory

## ELECTRICAL/CONTROLS

- 120-277Vac, 50/60Hz input
- 50W max output
- 2-55Vdc output per channel
- Isolated dimming circuit
- Operating temperature: -4°F to 122°F
- Class II rated
- Suitable for use in damp and dry locations
- Short circuit protection
- Overload protection
- Over-voltage protection
- Thermal protection
- Box: Length = 9", Width = 4", Height = 1-3/8"
- Driver: Length = 5-1/8", Width = 3", Height = 1-1/8"

PROJECT INFORMATION			
JOB NAME		TYPE	
ORDERING CODE			

## REMOTE DRIVER - NLIGHT ORDERING CODE

SERIES	P70414-COBRA	LED driver with box and harness
DIMMING	NLT	nLight control interface: standard Cat-5/RJ45 connection (female), dim to off
ELECTRICAL OPTIONS	350 500 700	350mA, 450 lm / ft 500mA, 600 lm / ft 700mA, 800 lm / ft

ORDERING CODE \_\_\_\_\_

Follow the steps to specify your fixture, example:  
P70414 - COBRA - NLT - 700

### MAXIMUM WIRING DISTANCE FROM DRIVER TO FIRST COBRA AT FULL LOAD

AWG VALUE	DISTANCE (FT)
20	46
18	72
17	92
16	118

## DESCRIPTION

- nLight dimmable protocol LED drive with smooth flicker free dimming
- Remote mounting distance up to 46' (20AWG), 72' (18AWG) to LED load
- Three programmable currents for various lumen offerings
- For custom drive currents consult factory

## ELECTRICAL/CONTROLS

- 120-277Vac, 50/60Hz input
- 50W max output
- 2-55Vdc output per channel
- Operating temperature: -4°F to 122°F
- Class II rated
- Suitable for use in damp and dry locations
- Short circuit protection
- Over-voltage protection
- Thermal protection
- Box: Length = 9", Width = 4", Height = 1-3/8"
- Driver: Length = 5-1/8", Width = 3", Height = 1-1/8"

## REMOTE DRIVER

