

Features

- Ultra High Efficiency (Up to 94.0%)
- Full Power at Wide Output Current Range (Constant Power)
- Thermal Sensing and Protection for LED Module
- DALI/3-Timer-Modes Dimmable
- Dim-to-Off with Standby Power ≤ 0.5 W
- Always-on Auxiliary Power: 12Vdc, 200mA
- Output Lumen Compensation
- Input Surge Protection: DM 6kV, CM 10kV
- All-Around Protection: OVP, SCP, OTP
- IP67 and UL Dry / Damp / Wet Location
- SELV Output
- TYPE HL, for use in a Class I, Division 2 hazardous (Classified) location
- 7 Years Warranty



Description

The EUD-320SxxxBT series is a 320W, constant-current, programmable LED driver that operates from 90-305 Vac input with excellent power factor. Created for many lighting applications including high bay, sports and horticultural, it provides a dim-to-off mode with low standby power. The high efficiency of these drivers and compact metal case enables them to run cooler, significantly improving reliability and extending product life. To ensure trouble-free operation, protection is provided against input surge, output over voltage, short circuit, and over temperature.

Models

Adjustable Output Current Range	Full-Power Current Range (1)	Default Output Current	Input Voltage Range(2)	Output Voltage Range	Max. Output Power	Typical Efficiency (3)	Typical Power Factor		Model Number
							120Vac	220Vac	
105-1500mA	1050-1500mA	1400 mA	90~305 Vac/ 127~300 Vdc	107~305Vdc	320 W	94.0%	0.99	0.96	EUD-320S150BT
154-2200mA	1540-2200mA	2100 mA	90~305 Vac/ 127~300 Vdc	73~208Vdc	320 W	93.5%	0.99	0.96	EUD-320S220BT
224-3200mA	2240-3200mA	2800 mA	90~305 Vac/ 127~300 Vdc	50~143Vdc	320 W	93.5%	0.99	0.96	EUD-320S320BT
322-4600mA	3220-4600mA	4200 mA	90~305 Vac/ 127~300 Vdc	35~100Vdc	320 W	93.5%	0.99	0.96	EUD-320S460BT ⁽⁴⁾
469-6700mA	4690-6700mA	6700 mA	90~305 Vac/ 127~300 Vdc	24 ~ 68Vdc	320 W	93.5%	0.99	0.96	EUD-320S670BT ⁽⁴⁾

Notes: (1) Output current range with constant power at 320W

(2) Certified input voltage range: UL, FCC 100-277Vac or 127-300Vdc; otherwise: 100-240Vac or 127-250Vdc

(3) Measured at 100% load and 220Vac input (see below "General Specifications" for details).

(4) SELV Output

I-V Operating Area

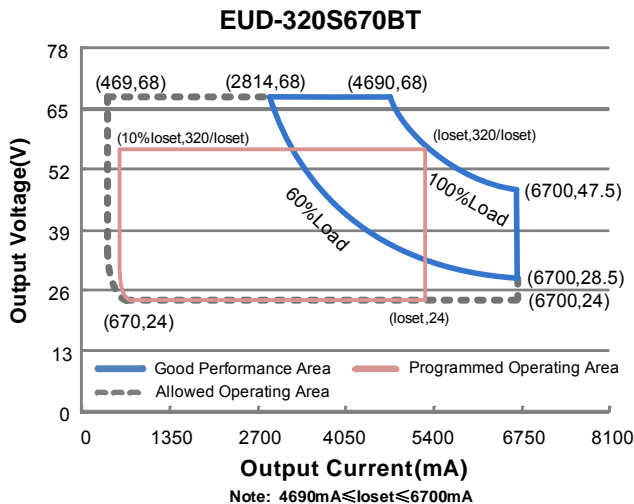
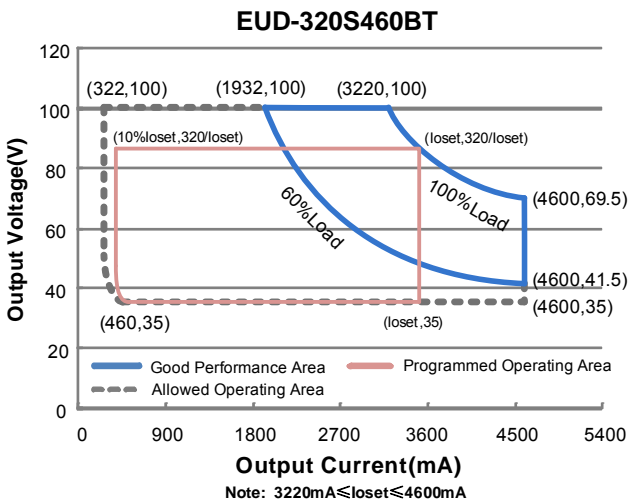
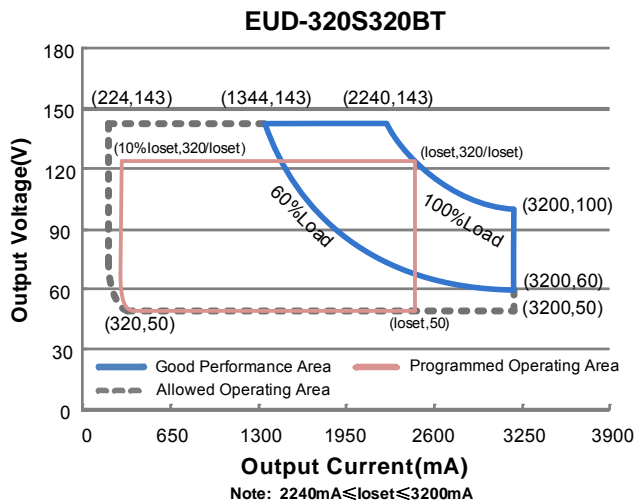
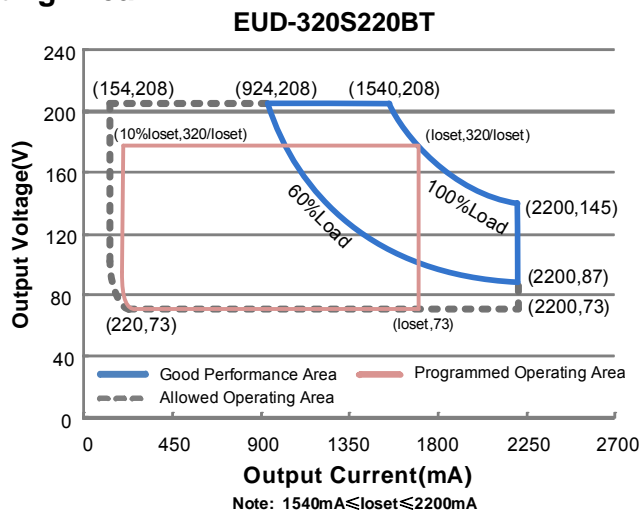
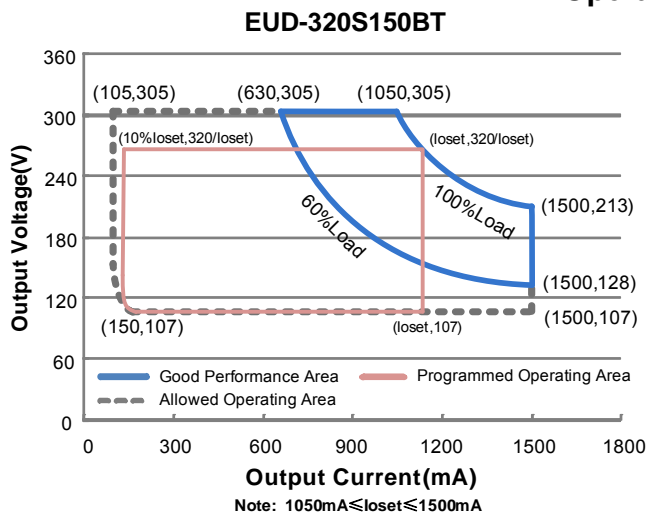

Input Specifications

Parameter	Min.	Typ.	Max.	Notes
Input AC Voltage	90 Vac	-	305 Vac	
Input DC Voltage	127 Vdc	-	300 Vdc	
Input Frequency	47 Hz	-	63 Hz	
Leakage Current	-	-	0.75 MIU	UL8750; 277Vac/ 60Hz, grounding effectively
	-	-	0.70 mA	IEC60598-1; 240Vac/ 60Hz, grounding effectively
Input AC Current	-	-	3.30 A	Measured at 100% load and 120 Vac input.
	-	-	1.80 A	Measured at 100% load and 220 Vac input.
Inrush Current(I ² t)	-	-	1.90 A ² s	At 220Vac input, 25°C cold start, duration=3.52 ms, 10%Ipk-10%Ipk. See Inrush Current Waveform for the details.
PF	0.90	-	-	At 100-277Vac, 50-60Hz, 60%-100% Load (192-320W)
THD	-	-	20%	
THD	-	-	10%	At 220-240Vac, 50-60Hz, 75%-100% Load (240-320W)

Output Specifications

Parameter	Min.	Typ.	Max.	Notes
Output Current Tolerance	-5%loset	-	5%loset	At 100% load condition
Output Current Setting(loset) Range				
EUD-320S150BT	105 mA	-	1500 mA	
EUD-320S220BT	154 mA	-	2200 mA	
EUD-320S320BT	224 mA	-	3200 mA	
EUD-320S460BT	322 mA	-	4600 mA	
EUD-320S670BT	469 mA	-	6700 mA	
Output Current Setting Range with Constant Power				
EUD-320S150BT	1050 mA	-	1500 mA	
EUD-320S220BT	1540 mA	-	2200 mA	
EUD-320S320BT	2240 mA	-	3200 mA	
EUD-320S460BT	3220 mA	-	4600 mA	
EUD-320S670BT	4690 mA	-	6700 mA	
Total Output Current Ripple (pk-pk)	-	5%lomax	10%lomax	At 100% load condition, 20 MHz BW
Output Current Ripple at < 200 Hz (pk-pk)	-	2%lomax	-	At 100% load condition. Only this component of ripple is associated with visible flicker.
Startup Overshoot Current	-	-	10%lomax	At 100% load condition
No Load Output Voltage				
EUD-320S150BT	-	-	350 V	
EUD-320S220BT	-	-	240 V	
EUD-320S320BT	-	-	160 V	
EUD-320S460BT	-	-	115 V	
EUD-320S670BT	-	-	78 V	
Line Regulation	-	-	±0.5%	Measured at 100% load

Output Specifications (Continued)

Parameter	Min.	Typ.	Max.	Notes
Load Regulation	-	-	± 1.5%	
Turn-on Delay Time	-	-	1.0 s	Measured at 120Vac input, 60%-100% Load
	-	-	0.5 s	Measured at 220Vac input, 60%-100% Load
Temperature Coefficient of I _o set	-	0.03%/°C	-	Case temperature = 0°C ~T _c max
12V Auxiliary Output Voltage	10.8 V	12 V	13.2 V	
12V Auxiliary Output Source Current	0 mA	-	200 mA	Return terminal is "OTP"

General Specifications

Parameter	Min.	Typ.	Max.	Notes
Efficiency at 120 Vac input:				
EUD-320S150BT				
I _o =1050mA	89.5%	91.5%	-	
I _o =1500mA	88.0%	90.0%	-	
EUD-320S220BT				
I _o =1540mA	89.5%	91.5%	-	
I _o =2200mA	88.5%	90.5%	-	
EUD-320S320BT				
I _o =2240mA	89.5%	91.5%	-	
I _o =3200mA	87.5%	89.5%	-	
EUD-320S460BT				
I _o =3220mA	89.0%	91.0%	-	
I _o =4600mA	87.5%	89.5%	-	
EUD-320S670BT				
I _o =4690mA	89.0%	91.0%	-	
I _o =6700mA	87.5%	89.5%	-	
Efficiency at 220 Vac input:				
EUD-320S150BT				
I _o =1050mA	92.0%	94.0%	-	
I _o =1500mA	90.5%	92.5%	-	
EUD-320S220BT				
I _o =1540mA	91.5%	93.5%	-	
I _o =2200mA	90.5%	92.5%	-	
EUD-320S320BT				
I _o =2240mA	91.5%	93.5%	-	
I _o =3200mA	90.0%	92.0%	-	
EUD-320S460BT				
I _o =3220mA	91.5%	93.5%	-	
I _o =4600mA	90.0%	92.0%	-	
EUD-320S670BT				
I _o =4690mA	91.5%	93.5%	-	
I _o =6700mA	89.5%	91.5%	-	

General Specifications (Continued)

Parameter	Min.	Typ.	Max.	Notes
Efficiency at 277 Vac input: EUD-320S150BT				Measured at 100% load and steady-state temperature in 25°C ambient; (Efficiency will be about 2.0% lower if measured immediately after startup.)
Io=1050mA	92.0%	94.0%	-	
Io=1500mA	91.0%	93.0%	-	
EUD-320S220BT				
Io=1540mA	92.0%	94.0%	-	
Io=2200mA	90.5%	92.5%	-	
EUD-320S320BT				
Io=2240mA	92.0%	94.0%	-	
Io=3200mA	90.0%	92.0%	-	
EUD-320S460BT				
Io=3220mA	91.5%	93.5%	-	
Io=4600mA	90.5%	92.5%	-	
EUD-320S670BT				
Io=4690mA	91.5%	93.5%	-	
Io=6700mA	90.0%	92.0%	-	
Standby power	-	-	0.5 W	Measured at 230Vac/50Hz; Dimming off
MTBF	-	237,000 Hours	-	Measured at 220Vac input, 80%Load and 25°C ambient temperature (MIL-HDBK-217F)
Lifetime	-	97,000 Hours	-	Measured at 220Vac input, 80%Load and 70°C case temperature; See lifetime vs. Tc curve for the details
Operating Case Temperature for Safety Tc_s	-40°C	-	+89°C	
Operating Case Temperature for Warranty Tc_w	-40°C	-	+75°C	Case temperature for 7 years warranty. Please see <i>Inventronics Warranty Statement for complete details.</i> Humidity: 10% RH to 95% RH
Storage Temperature	-40°C	-	+85°C	Humidity: 5%RH to 95%RH
Dimensions Inches (L × W × H) Millimeters (L × W × H)	8.86 × 3.86 × 1.77 225 × 98 × 44.8			With mounting ear 9.88 × 3.86 × 1.77 251 × 98 × 44.8
Net Weight	-	1875 g	-	

Dimming Specifications

Parameter	Min.	Typ.	Max.	Notes
DA, DA High Level	9.5V	16V	22.5V	
DA, DA Low Level	-6.5V	0V	6.5V	
DA, DA Current	0mA	-	2mA	

Dimming Specifications (Continued)

Parameter		Min.	Typ.	Max.	Notes
Dimming Output Range	EUD-320S150BT EUD-320S220BT EUD-320S320BT EUD-320S460BT EUD-320S670BT	10%loset	-	loset	1050mA ≤ loset ≤ 1500mA 1540mA ≤ loset ≤ 2200mA 2240mA ≤ loset ≤ 3200mA 3220mA ≤ loset ≤ 4600mA 4690mA ≤ loset ≤ 6700mA
	EUD-320S150BT EUD-320S220BT EUD-320S320BT EUD-320S460BT EUD-320S670BT	105mA 154mA 224mA 322mA 469mA	-	loset	105mA ≤ loset < 1050mA 154mA ≤ loset < 1540mA 224mA ≤ loset < 2240mA 322mA ≤ loset < 3220mA 469mA ≤ loset < 4690mA

Standards Compliance

Safety Category	Standard
UL/CUL	UL8750,CAN/CSA-C22.2 No. 250.13
CE	EN 61347-1, EN 61347-2-13
EMI Standards	Notes
EN 55015 ⁽¹⁾	Conducted emission Test & Radiated emission Test
EN 61000-3-2	Harmonic current emissions
EN 61000-3-3	Voltage fluctuations & flicker
FCC Part 15 ⁽¹⁾	ANSI C63.4 Class B
	This device complies with Part 15 of the FCC Rules. Operation is subject to the following two conditions: [1] this device may not cause harmful interference, and [2] this device must accept any interference received, including interference that may cause undesired Operation.
EMS Standards	Notes
EN 61000-4-2	Electrostatic Discharge (ESD): 8 kV air discharge, 4 kV contact discharge
EN 61000-4-3	Radio-Frequency Electromagnetic Field Susceptibility Test-RS
EN 61000-4-4	Electrical Fast Transient / Burst-EFT
EN 61000-4-5	Surge Immunity Test: AC Power Line: Differential Mode 6 kV, Common Mode 10 kV ⁽²⁾
EN 61000-4-6	Conducted Radio Frequency Disturbances Test-CS
EN 61000-4-8	Power Frequency Magnetic Field Test
EN 61000-4-11	Voltage Dips
EN 61547	Electromagnetic Immunity Requirements Applies To Lighting Equipment
DALI Standards	Notes
DALI	IEC62386-101,102 & part of 207 ⁽³⁾

- Note:** (1) This LED driver meets the EMI specifications above, but EMI performance of a luminaire that contains it depends also on the other devices connected to the driver and on the fixture itself.
- (2) To perform electric strength (hi-pot) testing, the "GDT ground disconnect" (nut and metal lock sheet) on the driver end-cap should be removed temporarily to prevent the internal gas discharge tube from conducting (as allowed by IEC 60598-1 Clause 10.2). After testing is completed, these items must be reinstalled to restore line-to-earth surge protection and secure the end cap.
- (3) Optional Commands Implemented: 242 (query short circuit), 243 (query open circuit)

Derating

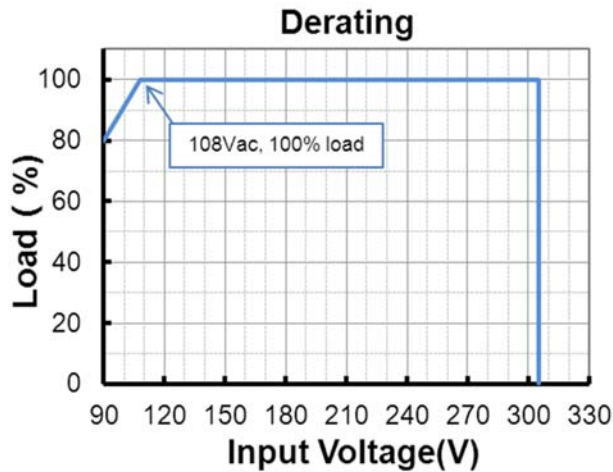

Lifetime vs. Case Temperature

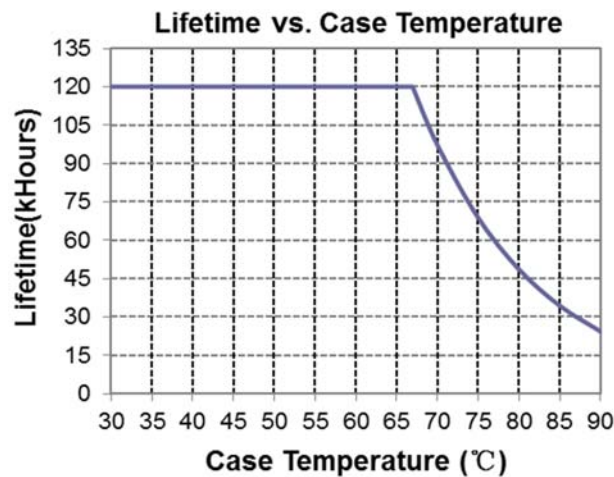

Inrush Current Waveform

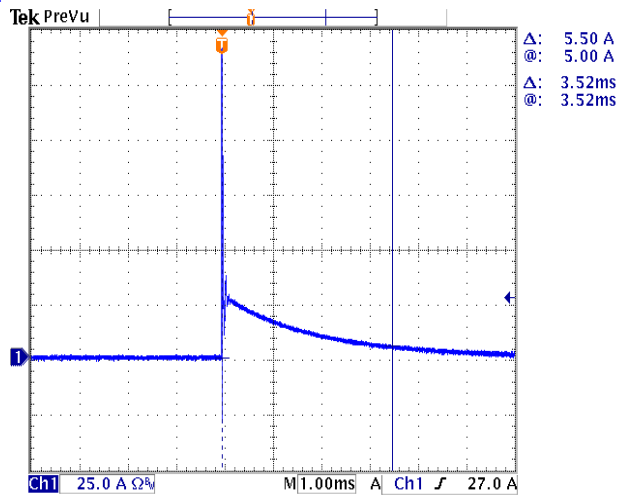

Efficiency vs. Load

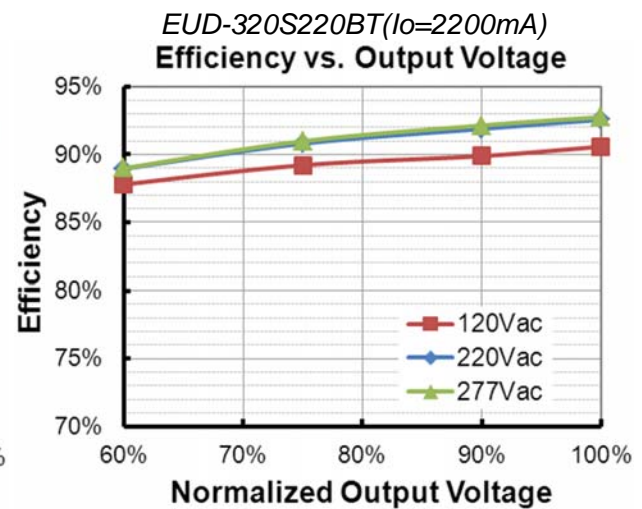
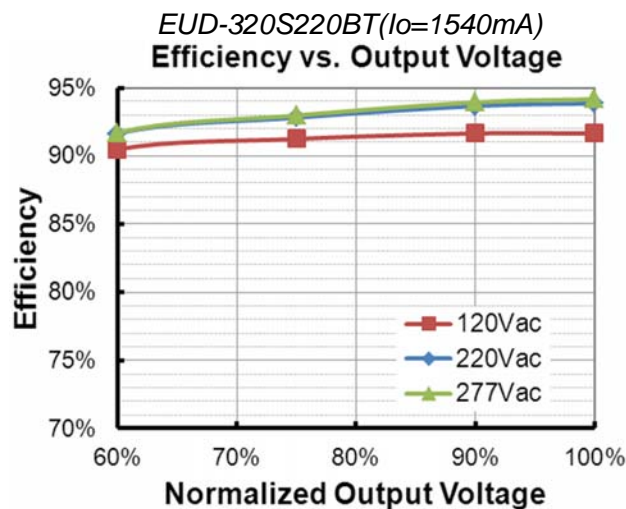
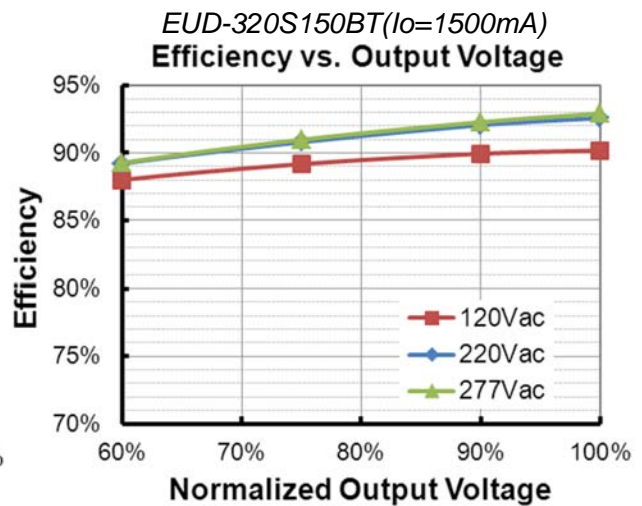
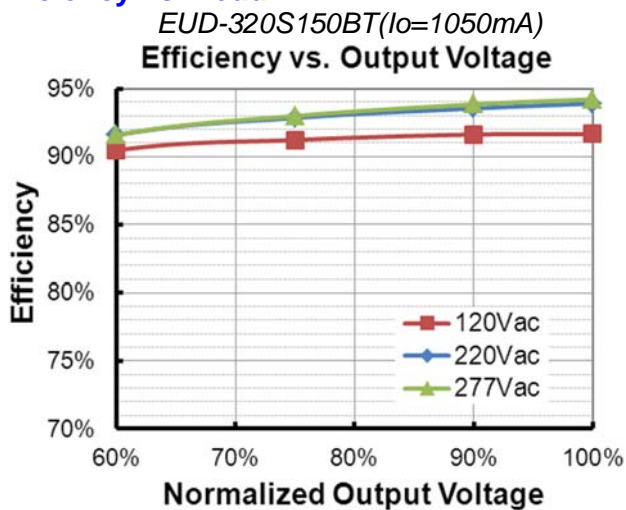

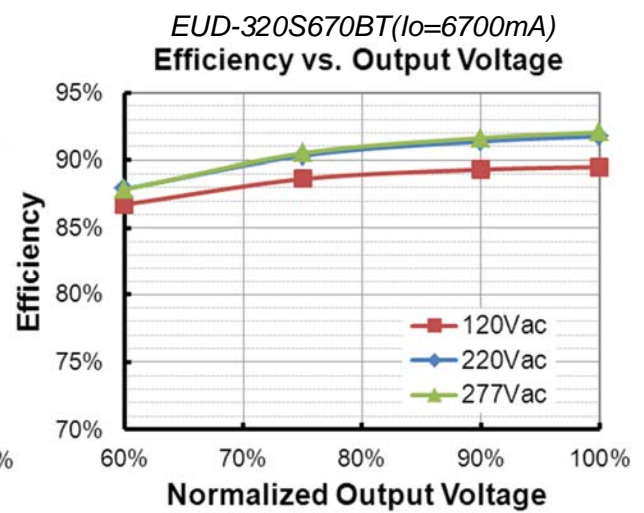
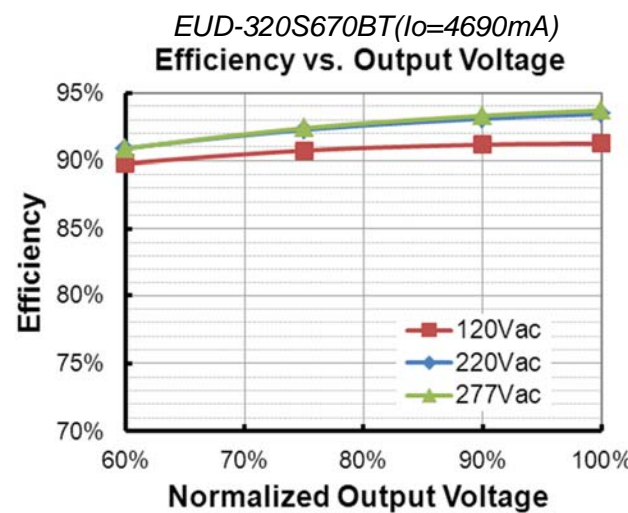
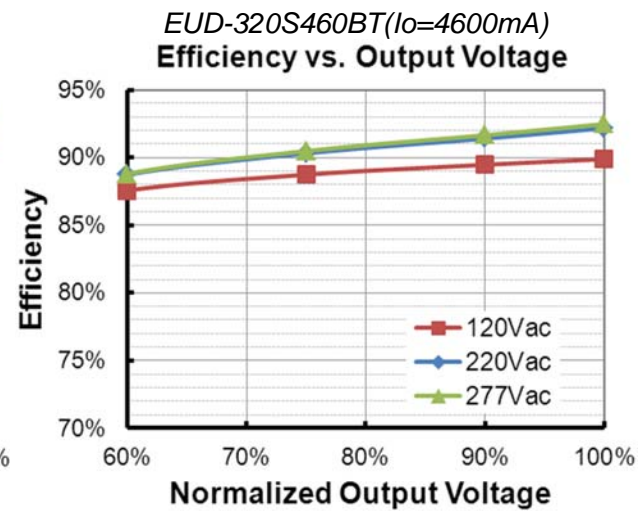
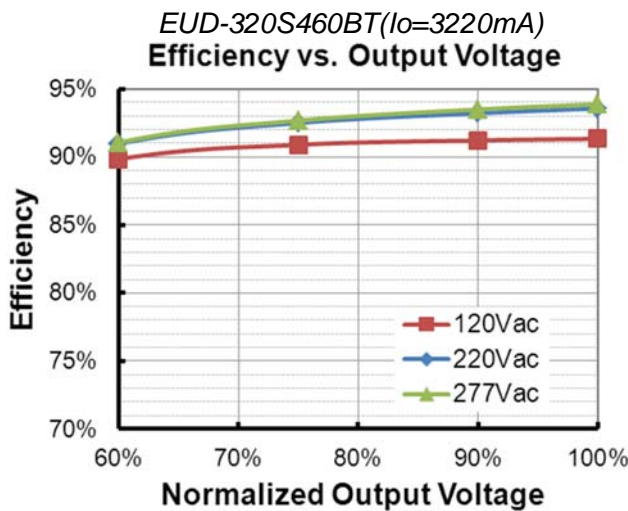
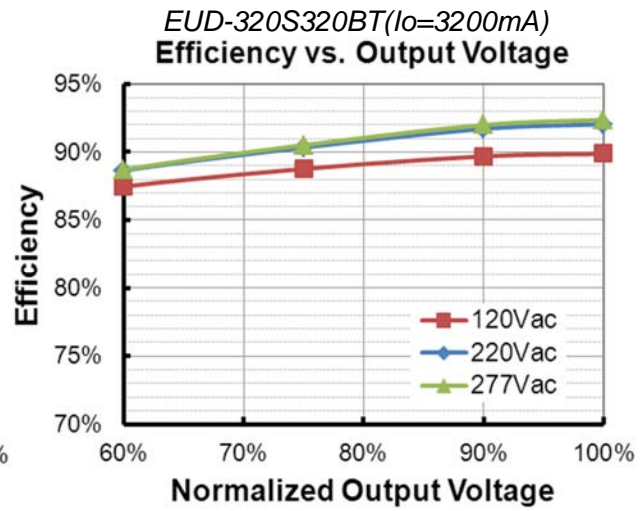
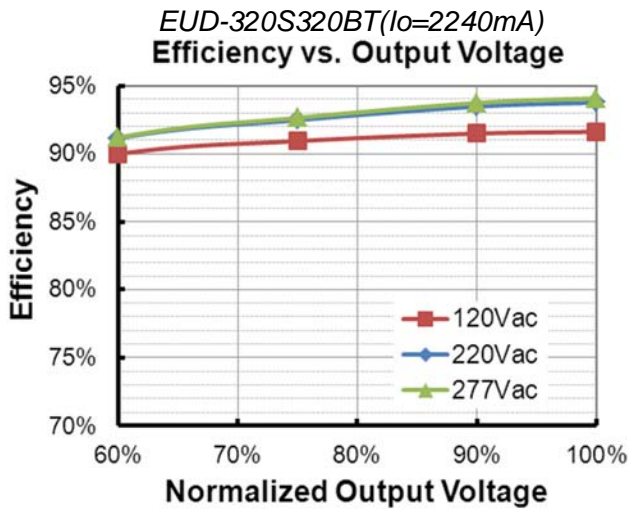

Power Factor

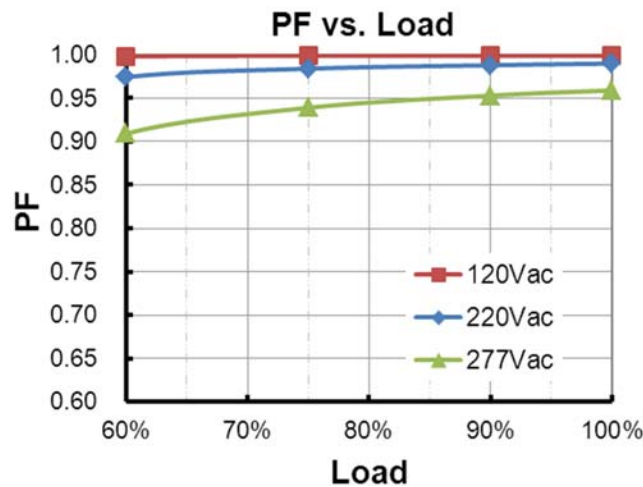

Total Harmonic Distortion

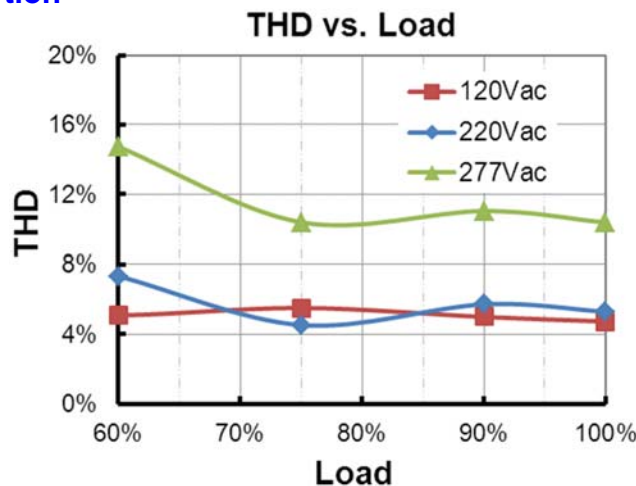

Protection Functions

Parameter		Min.	Typ.	Max.	Notes
External Thermal Protection NTC	R1	-	7.81 kOhm	-	When R_NTC falls below R1, External Thermal Protection is triggered, reducing output current until R2 is reached.
	R2	-	4.16 kOhm	-	When R_NTC is less than R2, output current is reduced to the programmed "Protection Current Floor."
	Protection Current Floor	10%loset	60%loset	100%loset	10%loset > Iomin (default setting is 60%)
		Iomin	60%loset	100%loset	10%loset ≤ Iomin (default setting is 60%)
Over Temperature Protection		Decreases output current, returning to normal after over temperature is removed.			
Short Circuit Protection		Auto Recovery. No damage will occur when any output is short circuited. The output shall return to normal when the fault condition is removed.			
Over Voltage Protection		Limits output voltage at no load and in case the normal voltage limit fails.			

Dimming

● DALI Dimming

The recommended implementation of the dimming control is provided below.

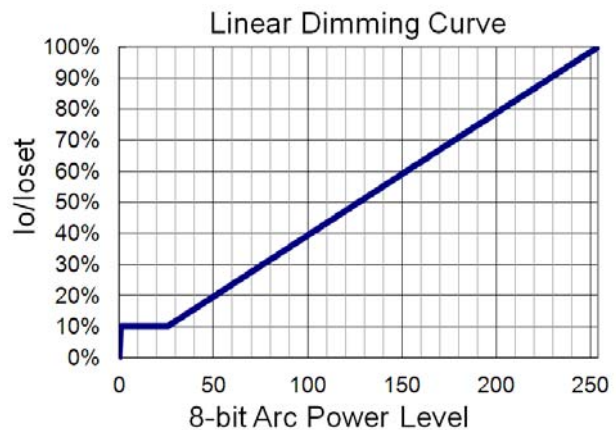
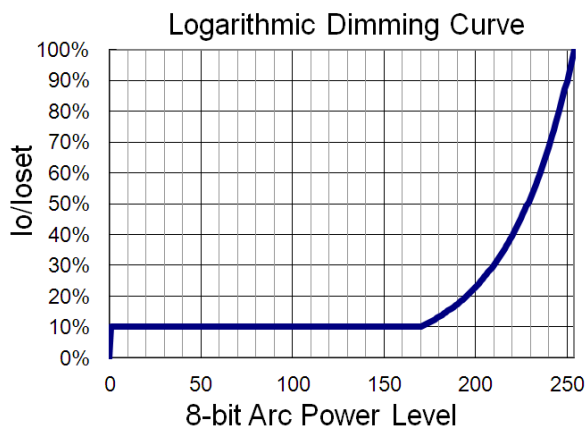
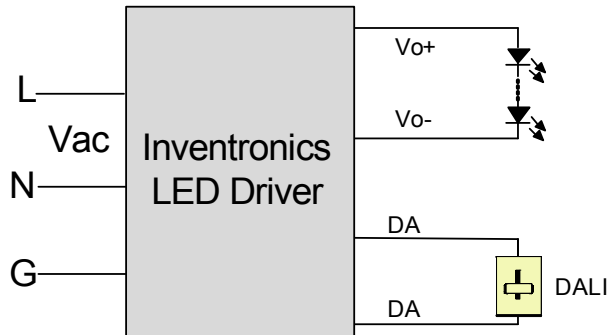

Implementation: DALI Dimming

● Time Dimming

Time dimming control includes 3 kinds of modes, they are Self Adapting-Midnight, Self Adapting-Percentage and Traditional Timer.

- **Self Adapting-Midnight:** Automatically adjusts the dimming curve based on the on-time of past two days (if difference <15 minutes), assuming that the center point of the dimming curve is midnight local time.
- **Self Adapting-Percentage:** Automatically adjusts the on-time of each step by a constant percentage = (actual on-time for the past 2 days if difference <15 min) / (programmed on-time from the dimming curve).
- **Traditional Timer:** Follows the programmed timing curve after power on with no changes.

● Output Lumen Compensation

Output Lumen Compensation (OLC) may be used to maintain constant light output over the life of the LEDs by driving them at a reduced current when new, then gradually increasing the drive current over time to counteract LED lumen degradation.

Revision History

Change Date	Rev.	Description of Change		
		Item	From	To
2017-05-09	A	Datasheets Release	/	/
2017-10-25	B	Features	7 Years Warranty	Added
		Input Specifications	PF/THD	Updated
		General Specifications	Operating Case Temperature for Warranty Tc_w	Updated
2018-01-22	C	Description	/	Updated
		General Specifications	Lifetime	Updated
		Operating Case Temperature for Warranty Tc_w	+70°C	+75°C
		Lifetime vs. Case Temperature	/	Updated
2022-02-25	D	Product Photograph	/	Updated
		Features	/	Updated
		General Specifications	Humidity:	Updated
		Standards Compliance	/	Updated
		Programming Connection Diagram	/	Updated
		Mechanical Outline	/	Updated
		RoHS Compliance	/	Updated