



### Electrical Specifications

#### Input

Input Voltage (VAC)	120V-277V (+/- 10%)	
Frequency Range (Hz)	50 - 60 Hz (+/- 10%)	
	<b>120V</b>	<b>277V</b>
Input Current (A)	1.7	0.75
THD @ Full load	<15%	<20%
Power Factor @ Full load	>0.95	>0.95
Efficiency @ Full load	≥90%	≥92%
Inrush Current (Apk)	44A, 190µs	131A, 190µs

#### Output

Output Current (mA)	350-800mA (1mA step)
Output Voltage (VDC)	82-280VDC
Output Ripple Current	< 20% @800mA
Max. Output Power (W)	180W
LED Power-Up Time	<0.5 sec
Load Regulation	< 5%
Line Regulation	< 5%
Over Voltage Protection	Yes, non-latching
Over Load Protection	Current fold back @185W, non-latching
Output Short-Circuit Protection	Yes, non-latching

### General Information

Item Number	*2743YH (79366)
Type	Constant Current
Output Power	180W (Max.)
Programming Tool	*274A17 (51645)
Software	<a href="#">Download</a>
Programmable Features	Output Current Dimming level LED thermal protection AstroDIM LEDSet Gen2 Constant lumen output End-of-life indicator

Find (NAED) as cross reference for new item number i.e. \*12345

### Environmental Specifications

Ambient Operating Temperature	-40°C to 55°C
Max. Case Temperature (Tc)	85°C <sup>1</sup> 90°C (max)
Max. Storage Temp.	70°C
Max. Relative Humidity (%)	95% non-condensing
Transient Protection	ANSI C82.77-5 Cat C Low 6.0kV <sup>2</sup>
IP Rating	IP66
UL Rating	Dry & Damp, Type HL
UL File number	E333135
EMI Compliance	FCC Part 15 Class A
Sound Rating	Class A

**1** - 5-yr warranty applicable at 85°C

**2** - Means only 4kV for common mode combination wave.

### Dimming

Dimming Control	0 - 10V (Isolated) <sup>3</sup> AstroDIM
Dimming Range	10-100% (50mA min)
Dimming Type	Analog
Source/Sink Current	0.9 mA

**CAUTION: Two power supplies if dimming is connected to non-class 2 circuits.**  
**3** - Class 2 or non-Class 2 wiring allowed.

### LED thermal protection (NTC)

NTC Value Active Range	≤25kΩ
Temperature Derating Start	User defined

External NTC cannot leave the fixture.  
The PRG/ NTC control circuit terminals or lead wires are not isolated.  
The external NTC needs to be isolated or separated by live parts.



## Wiring Diagram

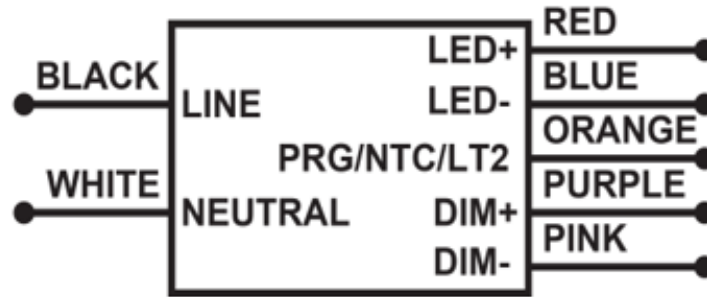

**Note:** - Maximum suggested remote mounting distance is 32 feet.

- The Dimming input is isolated and will allow Class 2 or non-Class 2 wiring across Purple and Pink wires.

## Mechanical Diagram

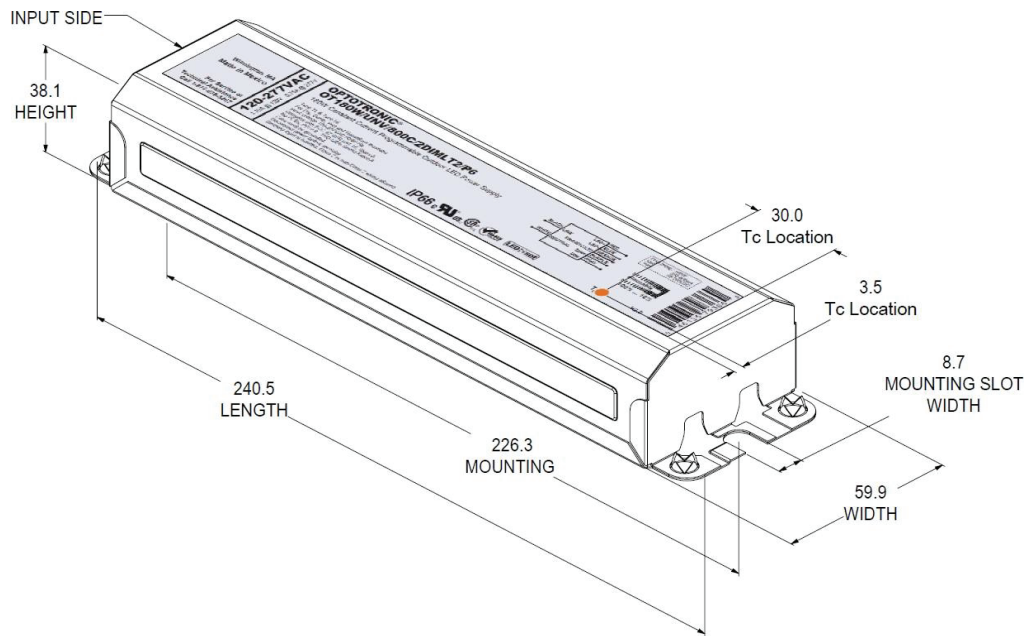

## Mechanical Specifications

Length	9.47" (240.5mm)
Width	2.36" (59.9mm)
Height	1.5" (38.1mm)
Mounting Length	8.74" (222.0mm)
Mounting Slot Width	0.34" (8.7mm)

---

## Operating Range

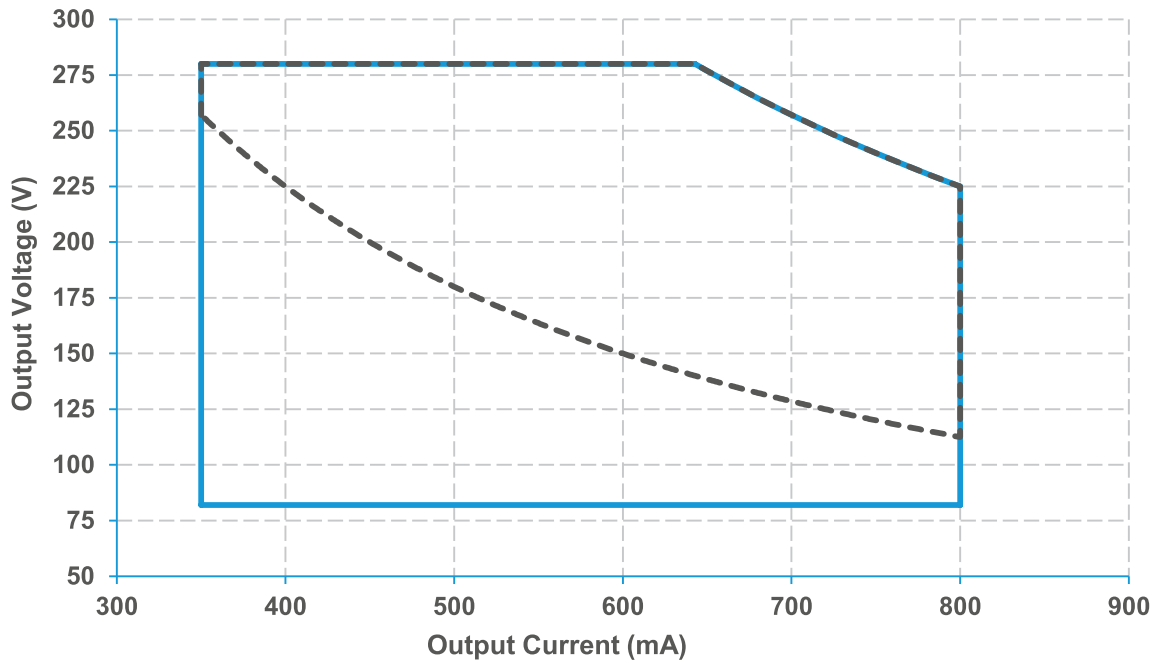

\*Pf > 0.9 and THD <20% at 120V and 277V.

---

## Dimming Curve

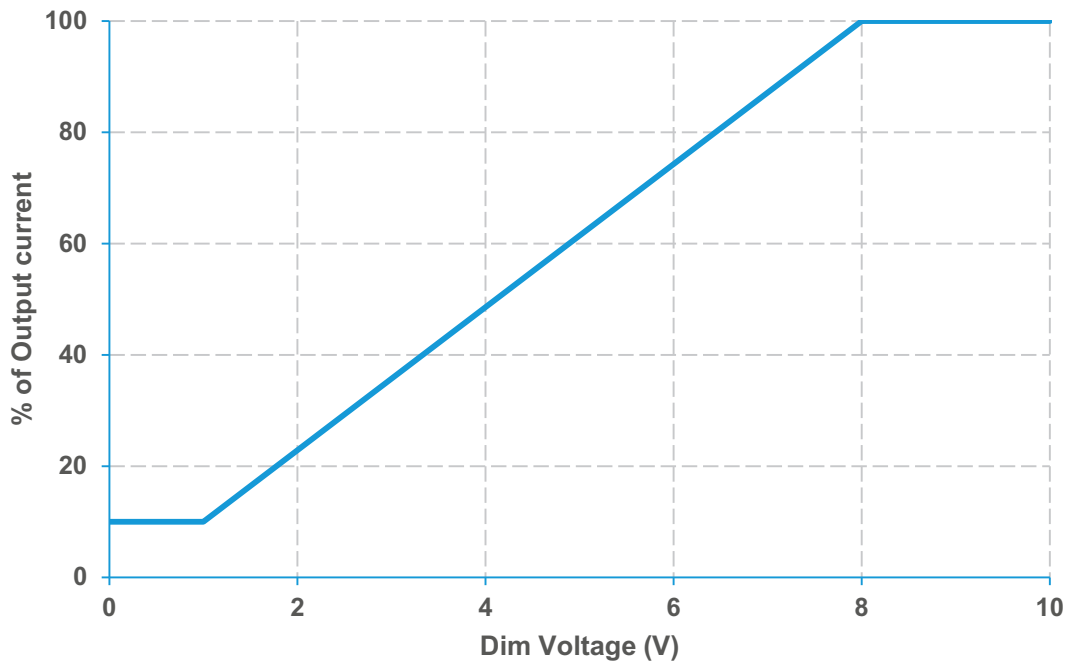

\*The absolute minimum current the driver can deliver is 50mA.

## Efficiency vs. Output Voltage

### Efficiency @ 120V

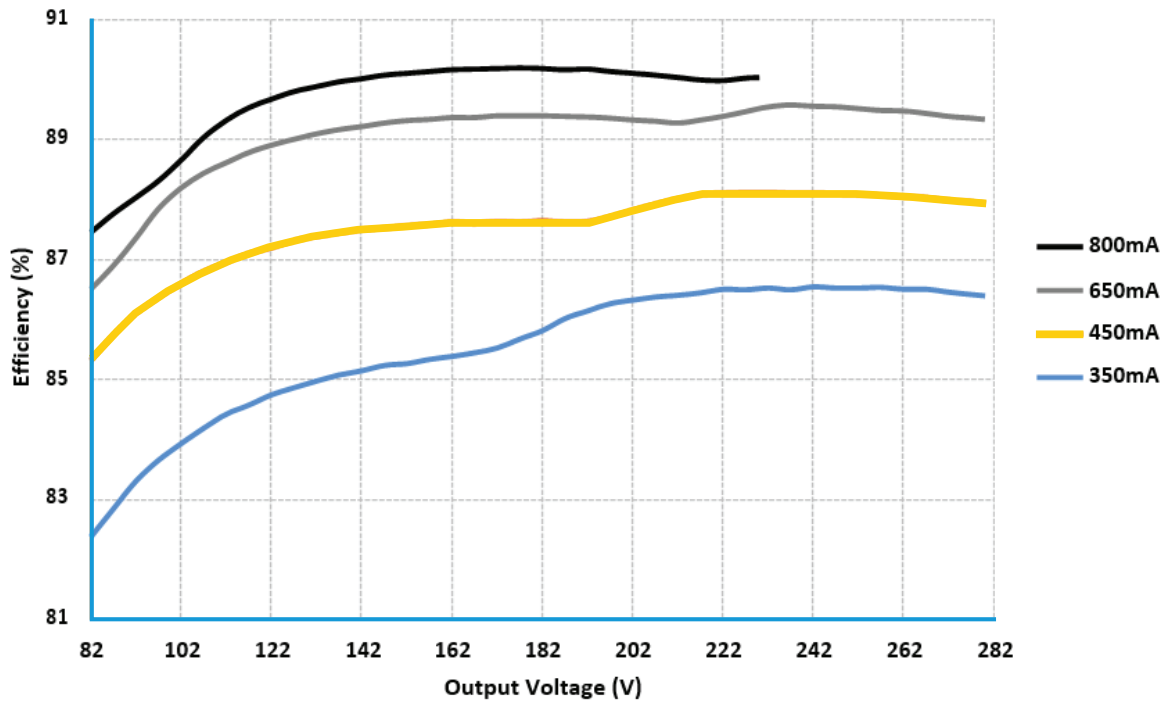

### Efficiency @ 277V

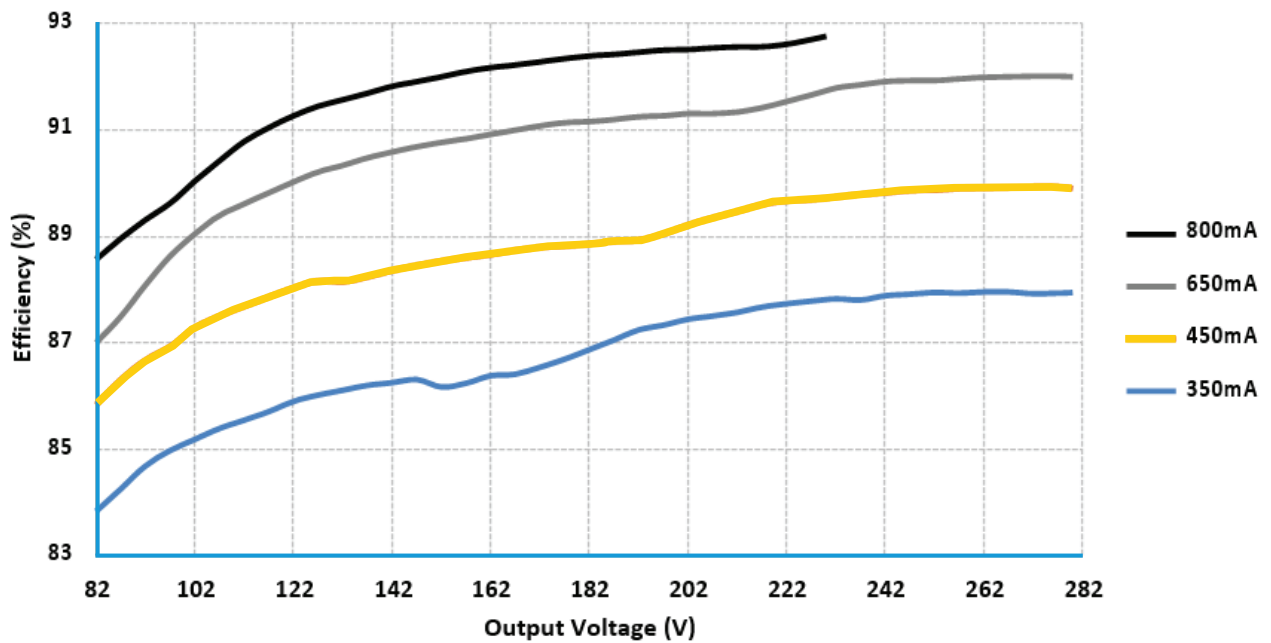

## Power Factor Performance

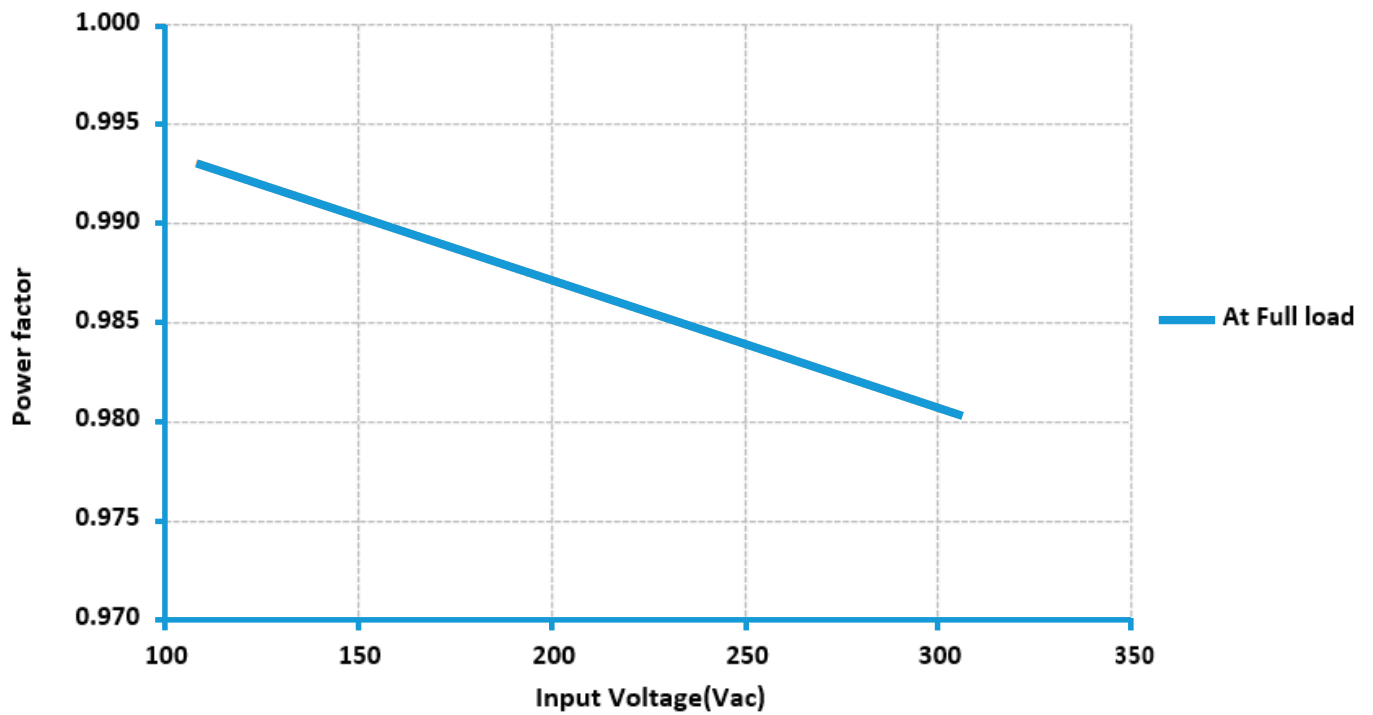
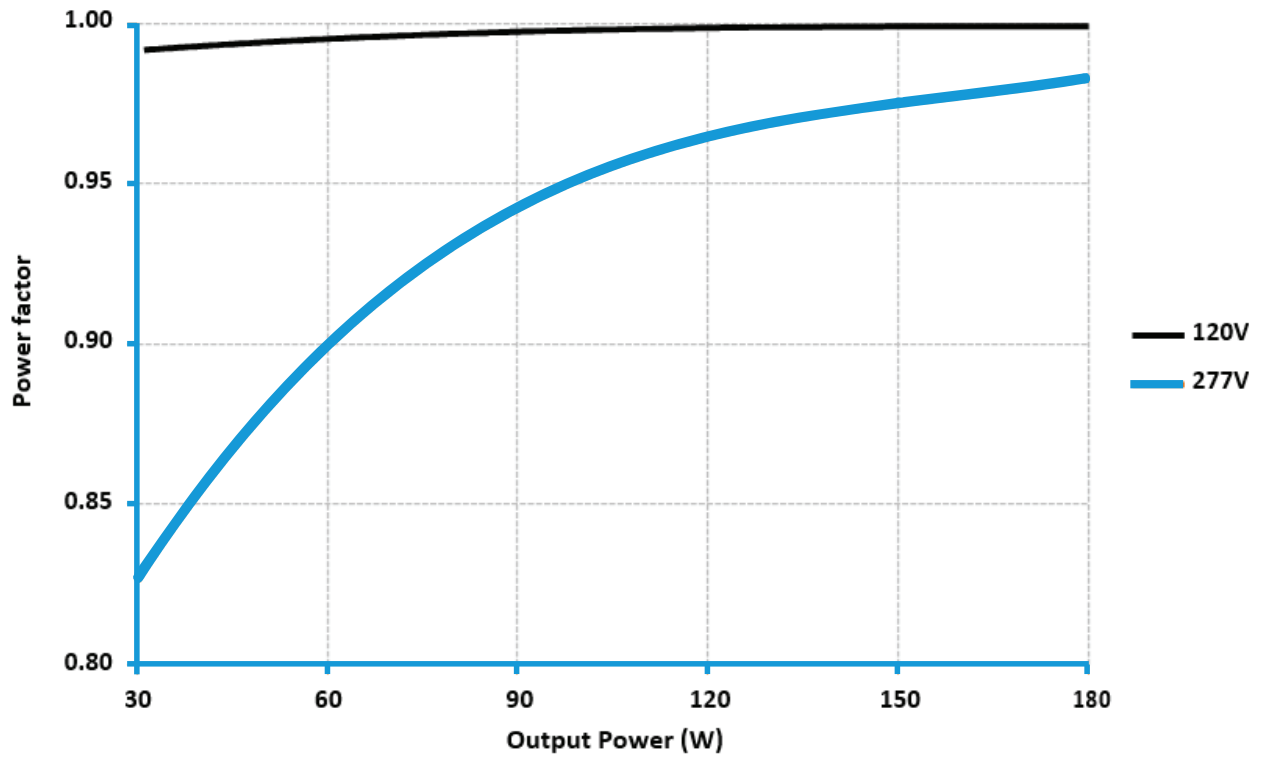

### THD Performance

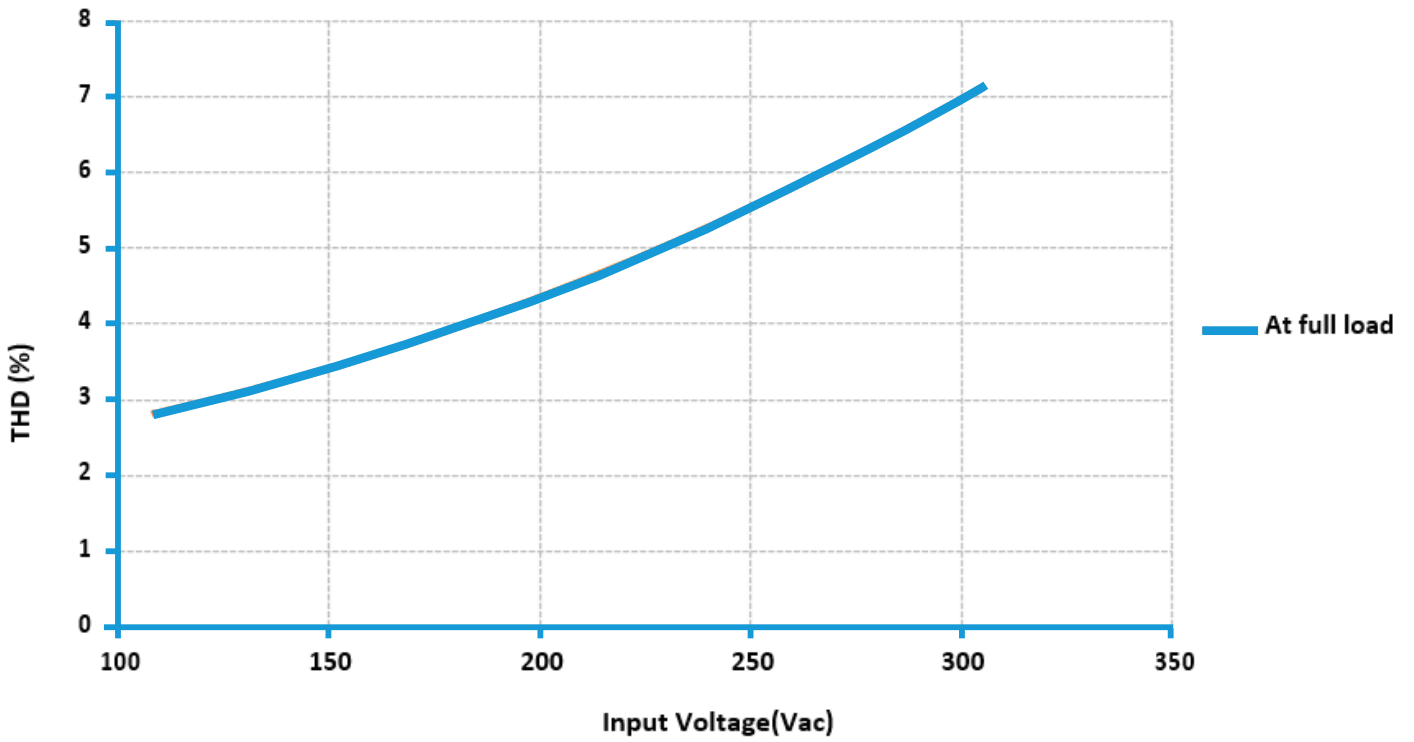
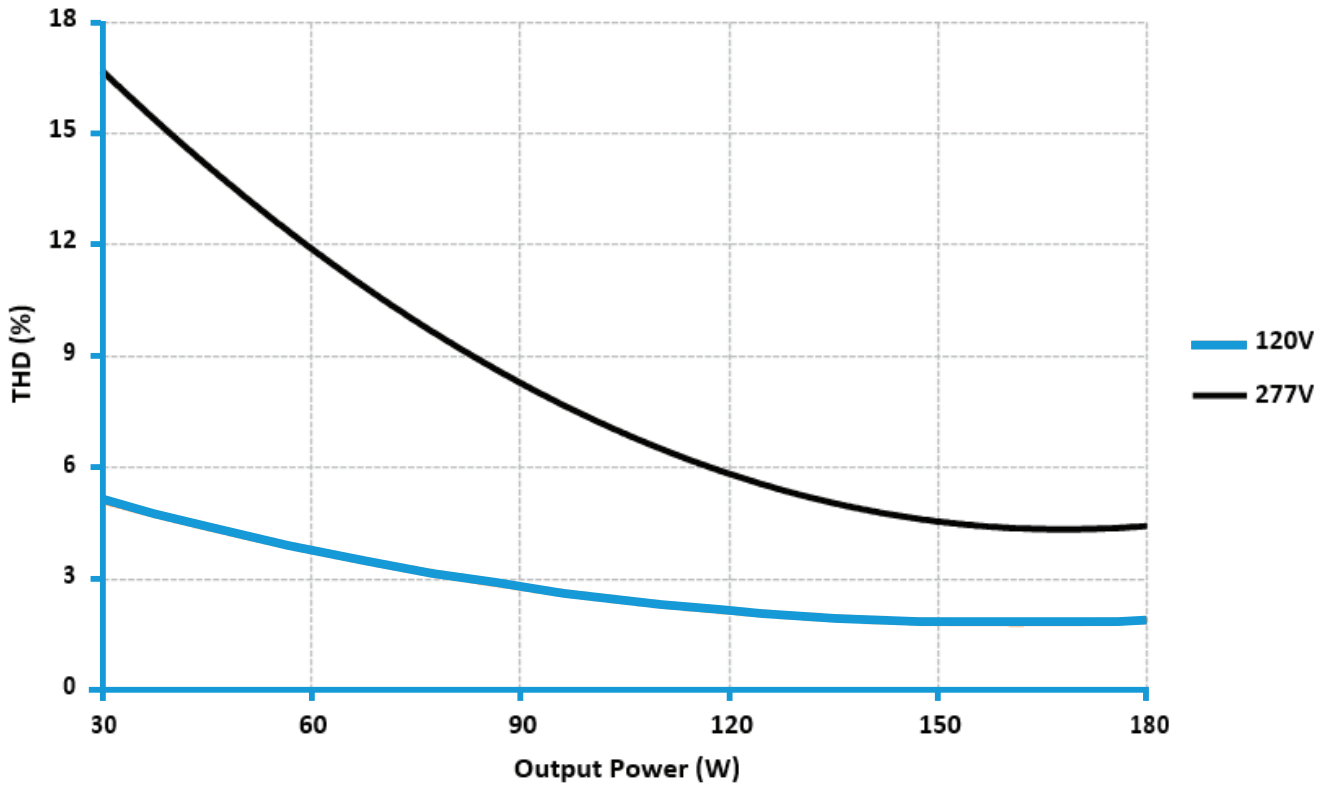

## LED Thermal Protection (NTC) Characteristic

The LED thermal protection feature of the OT180W helps reduce the temperature of the LED module by reducing the output current in case of abnormal temperature conditions. To use this feature a third party NTC thermistor should be connected to the LED power supply as shown in the wiring diagram below.

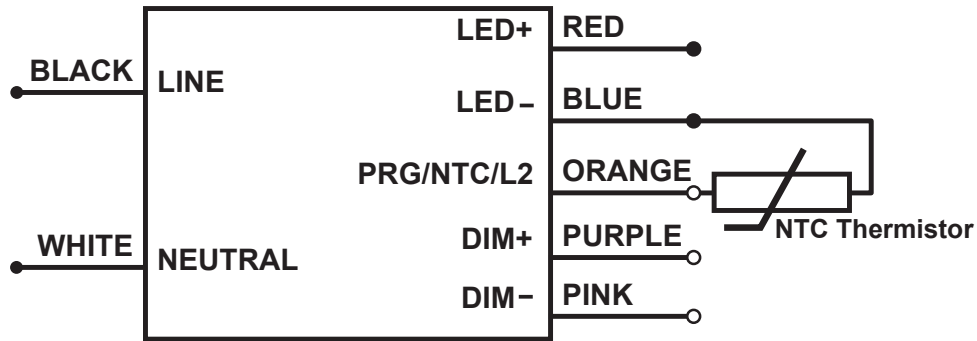

In the end application, care must be taken to place the NTC thermistor close to the hottest spot on the LED module. If LED thermal protection is not required the NTC port on the LED power supply connector can be left open.

Vishay, EPCOS, Murata, Panasonic are some of the manufacturers of NTC thermistor. EPCOS part number for reference only **B57164K153J (15k $\Omega$  @ 25 $^{\circ}$ C)**. Murata part number for reference only - **NCP03XH223J05RL (22k $\Omega$  @ 25 $^{\circ}$ C)**.

For detailed information on LED Thermal Protection, please refer to [Technical Application Guide](#) (ECS 304).

**Note:** Graphs for reference. The derating limits can be programmed using the OT Programmer.

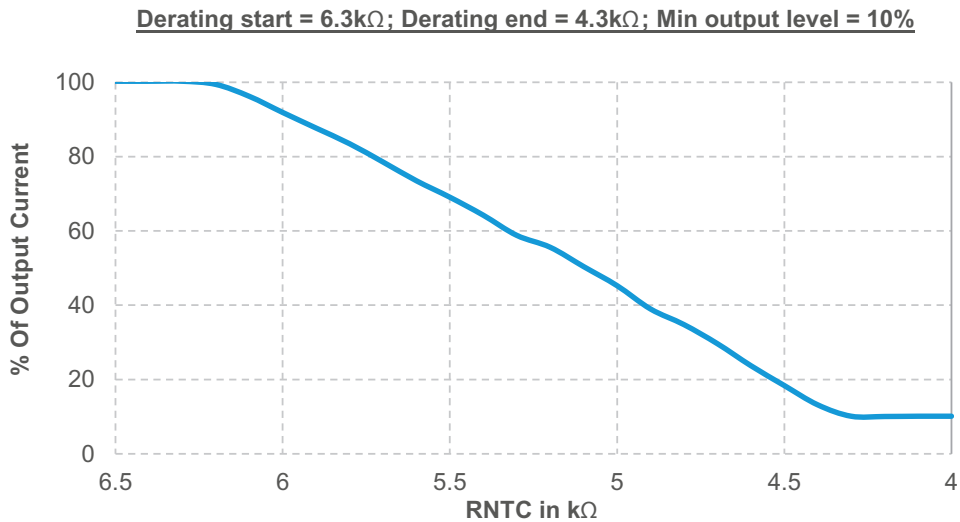

## End-of-Life Indicator

The End-of-Life indicator feature helps the end user to receive a signal from the fixture indicating that it has reached its programmed life-time. After the LED driver reaches the programmed life-time, whenever it is turned ON, it stays at Dim level (10%) for 10 minutes and reaches its appropriate level.

---

## AstroDIM

AstroDIM is an autonomous five level (1 Power ON & 4 Dimming levels) dimming protocol. It provides multi-stage night-time power reduction based on an internal timer; there is no need for an external control infrastructure. The ECG is automatically aligned to the on and off times for the street lighting and provide a defined output for the particular period of time. Compared with conventional systems there are significant cost savings. AstroDIM is designed for dimming without any external control wiring. Therefore, AstroDIM helps to save energy, extend the life of the driver and the LED module and reduce light pollution, even if only a power line is available. In AstroDIM operation, the driver executes a preset dimming profile, which can be reconfigured via the OT Programming Tool. The autonomous dimming is regulated by an integrated timer (no real-time clock), which adjusts the dimming profile according to the previous night (operation from switch-on to switch-off).

---

## LEDset 2

LEDset (Gen2) is an analog interface, allowing basic communication between a LED control gear and one or more LED modules. It allows setting the output current of the LED driver by providing a highly accurate voltage reference (Vset) to the driver. The interface supports the following functions:

- Output current setting of the constant current LED control gear to single LED modules as well as to series/parallel connected LED modules.
- Best matching of LED control gear and modules working point.
- Self-configuration according to system structure, automatic tracking of technology development.
- Easy mode of operation.
- Additional monitoring & protection features (e.g. thermal protection of the LED modules).

Therefore, the typical applications of this interface are single or multiple LED module parallel connections, offering an increasing choice of modular capabilities and low cost thermal protection circuits.

**Note:** When the LEDset feature is enabled, the LED Thermal protection (NTC) feature is disabled.

---

## Constant Lumen Maintenance

The Constant Lumen Maintenance feature of the OT180W helps to maintain the required lumen output of the fixture at a constant level throughout its lifetime. In general LED's lumen output will depreciate over time and in order to maintain sufficient light level towards the end of lifetime, the LED's are driven at high current initially and will result in more energy consumption. The constant lumen maintenance will give the flexibility to drive the LEDs at optimal driving current throughout its lifetime. This helps in energy savings, constant light output and enhanced reliability of the system.

**Note:** Step-by-step instructions are outlined in the OT Programmer User Manual embedded in the software.

---

## Dimmer/Sensor Compatibility

Manufacturer	Part Number
Digital Lumens	EN-ILCM-1R10V-GB2-BK EN-ILCM-1R10V-GB2-BK/DR EN-ALC-1R10V-GB2-BK EN-ALC-1R10V-GB2-BK/DR
Leviton	IP710-DLX
Lutron	DVTV-XX
Wattstopper	ADF-120277
Synergy Lighting Controls	ISD BC

---

**Note:** The absence of a dimmer from this chart does not necessarily imply incompatibility. Please reference the dimmer manufacturer's instructions for installation.

---

## Lifetime vs Case Temperature

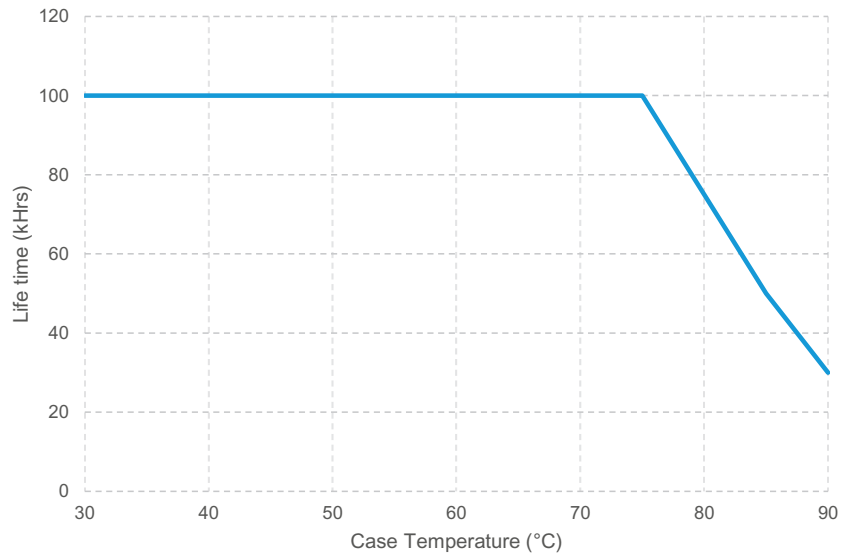

---

## Warranty

eldoLED OPTOTRONIC® Products are covered by a 5-year limited warranty. Complete warranty terms can be found at: [www.eldoled.com/legal/terms-and-conditions](http://www.eldoled.com/legal/terms-and-conditions)

### eldoLED

One Lithonia Way  
Conyers, GA 30012  
United States

+1 877 353 6533

nasupport@eldoLED.com  
www.eldoLED.com

ECS-OT440R1 10-22

©2022 Acuity Brands Lighting, Inc.  
Specifications subject to change without notice. Actual performance may differ as a result of end-user environment and application.