

Features

- Ultra High Efficiency (Up to 96.0%)
- Full Power at Wide Output Current Range (Constant Power)
- Adjustable Output Current (AOC) with Programmability
- Isolated 0-10V/PWM/3-Timer-Modes Dimmable
- INV Digital Dimming, UART Based Communication Protocol
- Dim-to-Off with Low Standby Power
- Minimum Dimming Level with 5% or 10% Selectable
- Maximum Dimming Level with 9V or 10V Selectable
- Fade Time Adjustable
- Always-on Auxiliary Power: 12Vdc, 250mA
- Low inrush current
- Output Lumen Compensation
- End-of-Life Indicator
- Input Surge Protection: DM 6kV, CM 10kV
- All-Around Protection: IUVP, IOVP, OVP, SCP, OTP
- IP66 / IP67 and UL Dry / Damp / Wet Location
- TYPE HL, for use in a Class I, Division 2 hazardous (Classified) location
- 5 Years Warranty



Description

The ESM-680SxxxMGS series is a 680W, constant-current, programmable and IP66/IP67 rated LED driver that operates from 249-528 Vac input with excellent power factor. Created for many lighting applications including high mast, sports, UV-LED, aquaculture and horticulture, etc. It provides an auxiliary voltage and dim-to-off functionality for powering low voltage, wireless controls. The dimming control supports 0-10V dimming as well as two-way communication via Digital Dimming, a UART based communication protocol. The high efficiency of these drivers and compact metal case enables them to run cooler, significantly improving reliability and extending product life. To ensure trouble-free operation, protection is provided against input surge, input under voltage, input over voltage, output over voltage, short circuit, and over temperature.

Models

Adjustable Output Current Range	Full-Power Current Range(1)	Default Output Current	Input Voltage Range(2)	Output Voltage Range	Max. Output Power	Typical Efficiency (3)	Typical Power Factor		Model Number
							277Vac	480Vac	
0.125-1.7A	1.25-1.7A	1.7 A	249~528Vac 352~500Vdc	200 ~ 544Vdc	680 W	96.0%	0.99	0.96	ESM-680S170MGS
0.18-2.4A	1.8-2.4A	2.1 A	249~528Vac 352~500Vdc	141.5 ~ 378Vdc	680 W	95.5%	0.99	0.96	ESM-680S240MGS
0.26-3.5A	2.6-3.5A	3.5 A	249~528Vac 352~500Vdc	97.1 ~ 262Vdc	680 W	95.5%	0.99	0.96	ESM-680S350MGS
0.42-5.6A	4.2-5.6A	5.6 A	249~528Vac 352~500Vdc	60.7 ~ 163Vdc	680 W	95.5%	0.99	0.96	ESM-680S560MGS
0.63-8.4A	6.3-8.4A	8.4 A	249~528Vac 352~500Vdc	40.4 ~ 108Vdc	680 W	95.5%	0.99	0.96	ESM-680S840MGS ⁽⁴⁾
1.26-15.0A	12.6-15.0A	15.0 A	249~528Vac 352~500Vdc	22.6 ~ 54Vdc	680 W	94.5%	0.99	0.96	ESM-680S15AMGS ⁽⁴⁾

- Notes:** (1) Output current range with constant power at 680W.
 (2) Certified voltage range: UL, FCC 277-480Vac; otherwise 277-400Vac.
 (3) Measured at 100% load and 480Vac input (see below "General Specifications" for details).
 (4) SELV output

I-V Operating Area

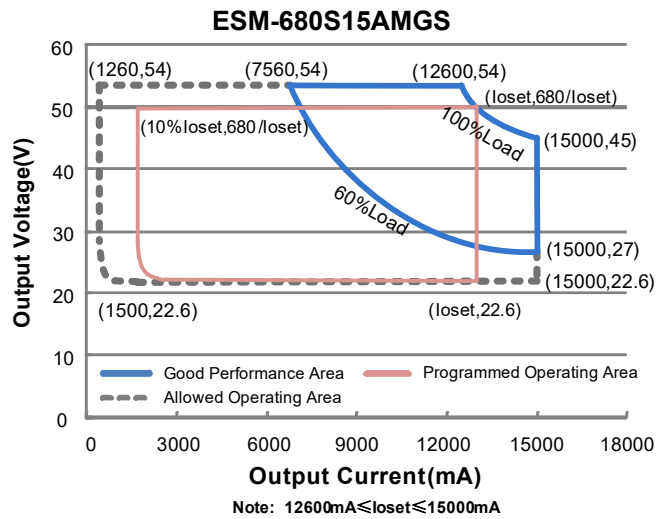
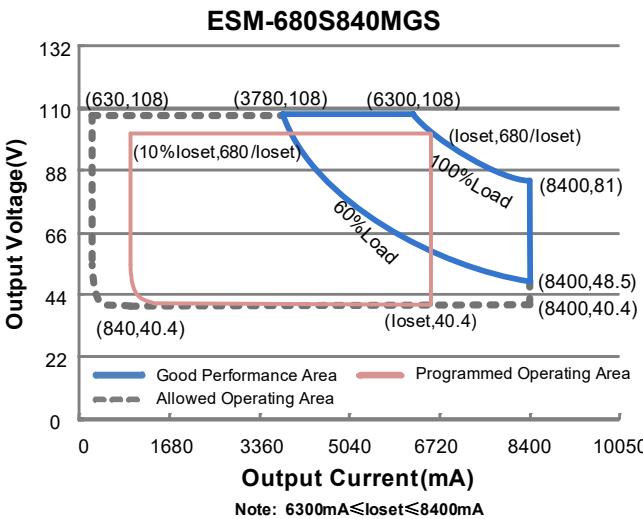
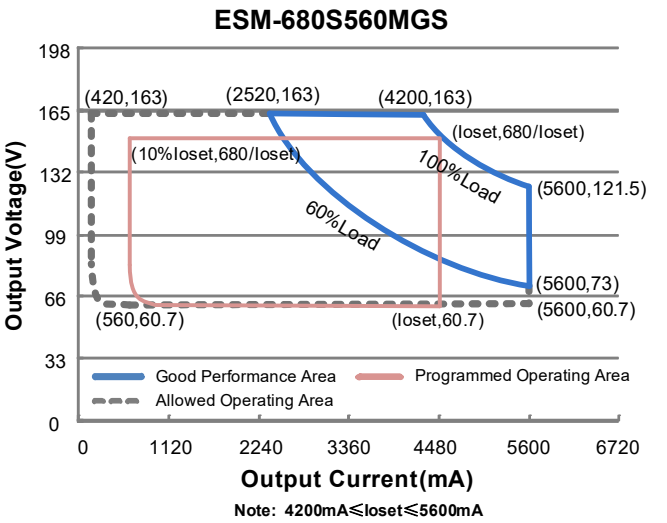
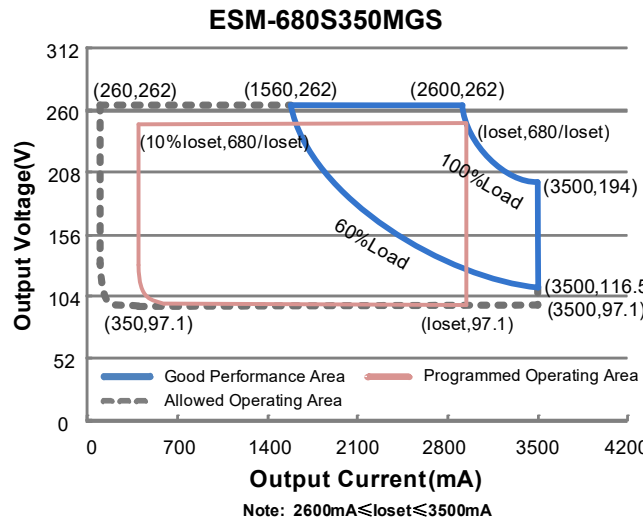
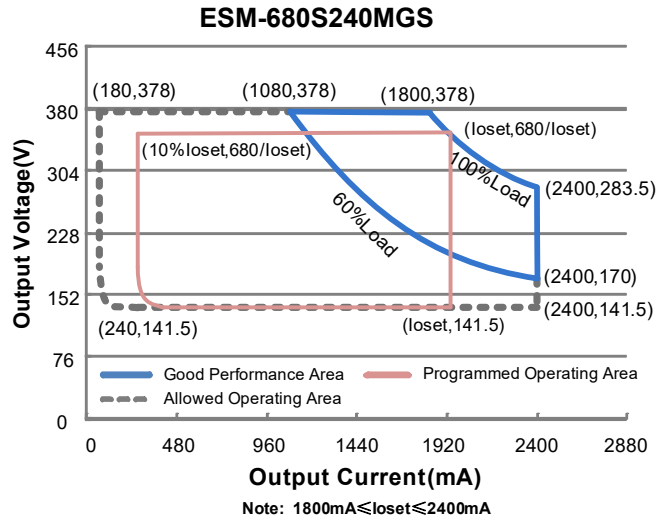
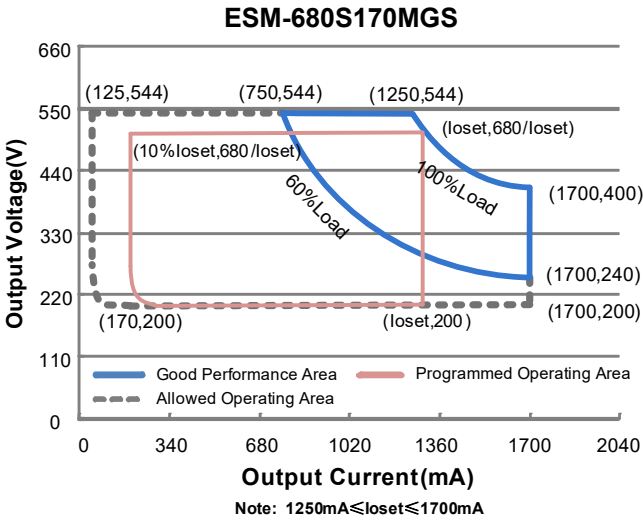

Input Specifications

Parameter	Min.	Typ.	Max.	Notes
Input AC Voltage	249 Vac	-	528 Vac	
Input DC Voltage	352 Vdc	-	500 Vdc	
Input Frequency	47 Hz	-	63 Hz	
Leakage Current	-	-	0.75 MIU	UL8750; 480Vac/ 60Hz
	-	-	0.70 mA	IEC60598-1; 480Vac/ 60Hz
Input AC Current	-	-	2.95 A	Measured at 100% load and 277 Vac input.
	-	-	1.72 A	Measured at 100% load and 480 Vac input.
Inrush Current(I ² t)	-	-	1.55 A ² s	At 480Vac input, 25°C cold start, duration= 6.56 ms, 10%Ipk-10%Ipk. See Inrush Current Waveform for the details.
PF	0.90	-	-	At 277-480Vac, 50-60Hz, 60%-100% Load (408 - 680W)
THD	-	-	20%	

Output Specifications

Parameter	Min.	Typ.	Max.	Notes
Output Current Tolerance	-5%loset	-	5%loset	100% load
Output Current Setting(loset) Range				
ESM-680S170MGS	125 mA	-	1700 mA	
ESM-680S240MGS	180 mA	-	2400 mA	
ESM-680S350MGS	260 mA	-	3500 mA	
ESM-680S560MGS	420 mA	-	5600 mA	
ESM-680S840MGS	630 mA	-	8400 mA	
ESM-680S15AMGS	1260 mA	-	15000 mA	
Output Current Setting Range with Constant Power				
ESM-680S170MGS	1250 mA	-	1700 mA	
ESM-680S240MGS	1800 mA	-	2400 mA	
ESM-680S350MGS	2600 mA	-	3500 mA	
ESM-680S560MGS	4200 mA	-	5600 mA	
ESM-680S840MGS	6300 mA	-	8400 mA	
ESM-680S15AMGS	12600 mA	-	15000 mA	
Total Output Current Ripple (pk-pk)	-	5%lomax	10%lomax	100% load, 20 MHz BW
Output Current Ripple at < 200Hz (pk-pk)	-	-	2%lomax	70%-100% load
Startup Overshoot Current	-	-	10%lomax	100% load
No Load Output Voltage				
ESM-680S170MGS	-	-	600 V	
ESM-680S240MGS	-	-	420 V	
ESM-680S350MGS	-	-	300 V	
ESM-680S560MGS	-	-	220 V	
ESM-680S840MGS	-	-	120 V	
ESM-680S15AMGS	-	-	60 V	
Line Regulation	-	-	±0.5%	100% load
Load Regulation	-	-	±3.0%	

Output Specifications (Continued)

Parameter	Min.	Typ.	Max.	Notes
Turn-on Delay Time	-	-	0.5 s	Measured at 277-480Vac input, 60%-100% Load
Temperature Coefficient of I _o set	-	0.03%/°C	-	Case temperature = 0°C ~T _c max
12V Auxiliary Output Voltage(V _{aux} /12V)	10.8 V	12 V	13.2 V	
12V Auxiliary Output Source Current	0 mA	-	250 mA	Return terminal is "Dim"
12V Auxiliary Output Transient Peak Current@6W	-	-	500 mA	500mA peak for a maximum duration of 2.2 ms in a 6.0ms period during which time the average should not exceed 250mA.
12V Auxiliary Output Transient Peak Current@10W	-	-	850 mA	850mA peak for a maximum duration of 1.3 ms in a 5.2ms period during which time the average should not exceed 250mA.

General Specifications

Parameter	Min.	Typ.	Max.	Notes
Efficiency at 277 Vac input:				
ESM-680S170MGS				
I _o = 1250 mA	92.5%	94.5%	-	
I _o = 1700 mA	92.0%	94.0%	-	
ESM-680S240MGS				
I _o = 1800 mA	92.0%	94.0%	-	
I _o = 2400 mA	91.5%	93.5%	-	
ESM-680S350MGS				
I _o = 2600 mA	92.5%	94.5%	-	Measured at 100% load and steady-state temperature in 25°C ambient; (Efficiency will be about 2.0% lower if measured immediately after startup.)
I _o = 3500 mA	92.0%	94.0%	-	
ESM-680S560MGS				
I _o = 4200 mA	92.0%	94.0%	-	
I _o = 5600 mA	91.5%	93.5%	-	
ESM-680S840MGS				
I _o = 6300 mA	92.0%	94.0%	-	
I _o = 8400 mA	91.0%	93.0%	-	
ESM-680S15AMGS				
I _o = 12600 mA	91.5%	93.5%	-	
I _o = 15000 mA	91.5%	93.5%	-	
Efficiency at 400 Vac input:				
ESM-680S170MGS				
I _o = 1250 mA	93.5%	95.5%	-	Measured at 100% load and steady-state temperature in 25°C ambient; (Efficiency will be about 2.0% lower if measured immediately after startup.)
I _o = 1700 mA	92.5%	94.5%	-	
ESM-680S240MGS				
I _o = 1800 mA	93.0%	95.0%	-	
I _o = 2400 mA	92.0%	94.0%	-	
ESM-680S350MGS				
I _o = 2600 mA	93.5%	95.5%	-	
I _o = 3500 mA	92.5%	94.5%	-	
ESM-680S560MGS				
I _o = 4200 mA	93.0%	95.0%	-	
I _o = 5600 mA	92.5%	94.5%	-	
ESM-680S840MGS				
I _o = 6300 mA	93.0%	95.0%	-	
I _o = 8400 mA	92.0%	94.0%	-	
ESM-680S15AMGS				
I _o = 12600 mA	92.0%	94.0%	-	
I _o = 15000 mA	92.5%	94.5%	-	

General Specifications (Continued)

Parameter	Min.	Typ.	Max.	Notes	
Efficiency at 480 Vac input: ESM-680S170MGS I _o = 1250 mA I _o = 1700 mA	94.0% 93.0%	96.0% 95.0%	- -	Measured at 100% load and steady-state temperature in 25°C ambient; (Efficiency will be about 2.0% lower if measured immediately after startup.)	
ESM-680S240MGS I _o = 1800 mA I _o = 2400 mA	93.5% 92.5%	95.5% 94.5%	- -		
ESM-680S350MGS I _o = 2600 mA I _o = 3500 mA	93.5% 93.0%	95.5% 95.0%	- -		
ESM-680S560MGS I _o = 4200 mA I _o = 5600 mA	93.5% 92.5%	95.5% 94.5%	- -		
ESM-680S840MGS I _o = 6300 mA I _o = 8400 mA	93.5% 92.5%	95.5% 94.5%	- -		
ESM-680S15AMGS I _o = 12600 mA I _o = 15000 mA	92.5% 92.5%	94.5% 94.5%	- -		
Standby Power	-	1.5 W	-		Measured at 480Vac/50Hz; Dimming off
MTBF	-	200,000 Hours	-		Measured at 480Vac input, 80%Load and 25°C ambient temperature (MIL-HDBK-217F)
Lifetime	-	102,000 Hours	-		Measured at 480Vac input, 80%Load and 70°C case temperature; See lifetime vs. T _c curve for the details
	-	50,000 Hours	-		Measured at 277Vac input, 100%Load and 40°C ambient temperature
Operating Case Temperature for Safety T _{c_s}	-40°C	-	+90°C		
Operating Case Temperature for Warranty T _{c_w}	-40°C	-	+80°C	Case temperature for 5 years warranty Humidity: 10% RH to 95% RH	
Storage Temperature	-40°C	-	+85°C	Humidity: 5%RH to 95%RH	
Dimensions Inches (L × W × H) Millimeters (L × W × H)	10.83 × 5.95 × 1.81 275 × 151 × 46			With mounting ear 11.81 × 5.95 × 1.81 300 × 151 × 46	
Net Weight	-	3230 g	-		

Dimming Specifications

Parameter	Min.	Typ.	Max.	Notes
Absolute Maximum Voltage on the V _{dim} (+) Pin	-20 V	-	20 V	
Source Current on V _{dim} (+)Pin	200 uA	300 uA	450 uA	V _{dim} (+) = 0 V

Dimming Specifications (Continued)

Parameter		Min.	Typ.	Max.	Notes
Dimming Output Range with 10%-100% (Default)	ESM-680S170MGS ESM-680S240MGS ESM-680S350MGS ESM-680S560MGS ESM-680S840MGS ESM-680S15AMGS	10%loset	-	loset	1250 mA ≤ loset ≤ 1700 mA 1800 mA ≤ loset ≤ 2400 mA 2600 mA ≤ loset ≤ 3500 mA 4200 mA ≤ loset ≤ 5600 mA 6300 mA ≤ loset ≤ 8400 mA 12600 mA ≤ loset ≤ 15000 mA
	ESM-680S170MGS ESM-680S240MGS ESM-680S350MGS ESM-680S560MGS ESM-680S840MGS ESM-680S15AMGS	125 mA 180 mA 260 mA 420 mA 630 mA 1260 mA	-	loset	125 mA ≤ loset < 1250 mA 180 mA ≤ loset < 1800 mA 260 mA ≤ loset < 2600 mA 420 mA ≤ loset < 4200 mA 630 mA ≤ loset < 6300 mA 1260 mA ≤ loset < 12600 mA
Dimming Output Range with 5%-100% (Settable)	ESM-680S170MGS ESM-680S240MGS ESM-680S350MGS ESM-680S560MGS ESM-680S840MGS ESM-680S15AMGS	5%loset	-	loset	1250 mA ≤ loset ≤ 1700 mA 1800 mA ≤ loset ≤ 2400 mA 2600 mA ≤ loset ≤ 3500 mA 4200 mA ≤ loset ≤ 5600 mA 6300 mA ≤ loset ≤ 8400 mA 12600 mA ≤ loset ≤ 15000 mA
	ESM-680S170MGS ESM-680S240MGS ESM-680S350MGS ESM-680S560MGS ESM-680S840MGS ESM-680S15AMGS	63 mA 90 mA 130 mA 210 mA 315 mA 630 mA	-	loset	125 mA ≤ loset < 1250 mA 180 mA ≤ loset < 1800 mA 260 mA ≤ loset < 2600 mA 420 mA ≤ loset < 4200 mA 630 mA ≤ loset < 6300 mA 1260 mA ≤ loset < 12600 mA
Recommended Dimming Input Range		0 V	-	10 V	Default 0-10V dimming mode.
Dim off Voltage		0.35 V	0.5 V	0.65 V	
Dim on Voltage		0.55 V	0.7 V	0.85 V	
Hysteresis		-	0.2 V	-	
PWM_in High Level		3 V	-	10 V	Dimming mode set to PWM in PC interface.
PWM_in Low Level		-0.3 V	-	0.6 V	
PWM_in Frequency Range		200 Hz	-	3 KHz	
PWM_in Duty Cycle		1%	-	99%	
PWM Dimming off (Positive Logic)		3%	5%	8%	
PWM Dimming on (Positive Logic)		5%	7%	10%	
PWM Dimming off (Negative Logic)		92%	95%	97%	
PWM Dimming on (Negative Logic)		90%	93%	95%	
Hysteresis		-	2%	-	

Safety & EMC Compliance

Safety Category	Standard
UL/CUL	UL 8750,CAN/CSA-C22.2 No. 250.13
ENEC & CE	EN 61347-1, EN 61347-2-13
UKCA	BS EN 61347-1, BS EN 61347-2-13

Safety & EMC Compliance (Continued)

Safety Category	Standard
CB	IEC 61347-1, IEC 61347-2-13
EAC	ГОСТ Р МЭК 61347-1, ГОСТ IEC 61347-2-13
EMI Standards	Notes
BS EN/EN 55015 ⁽¹⁾	Conducted emission Test & Radiated emission Test
BS EN/EN 61000-3-2	Harmonic current emissions
BS EN/EN 61000-3-3	Voltage fluctuations & flicker
FCC Part 15 ⁽¹⁾	ANSI C63.4 Class B
	This device complies with Part 15 of the FCC Rules. Operation is subject to the following two conditions: [1] this device may not cause harmful interference, and [2] this device must accept any interference received, including interference that may cause undesired Operation.
EMS Standards	Notes
BS EN/EN 61000-4-2	Electrostatic Discharge (ESD): 8kV air discharge, 4kV contact discharge
BS EN/EN 61000-4-3	Radio-Frequency Electromagnetic Field Susceptibility Test-RS
BS EN/EN 61000-4-4	Electrical Fast Transient / Burst-EFT
BS EN/EN 61000-4-5	Surge Immunity Test: AC Power Line: Differential Mode 6kV, Common Mode 10kV
BS EN/EN 61000-4-6	Conducted Radio Frequency Disturbances Test-CS
BS EN/EN 61000-4-8	Power Frequency Magnetic Field Test
BS EN/EN 61000-4-11	Voltage Dips
BS EN/EN 61547	Electromagnetic Immunity Requirements Applies To Lighting Equipment

Note: (1) This LED driver meets the EMI specifications above, but EMI performance of a luminaire that contains it depends also on the other devices connected to the driver and on the fixture itself.

Lifetime vs. Case Temperature

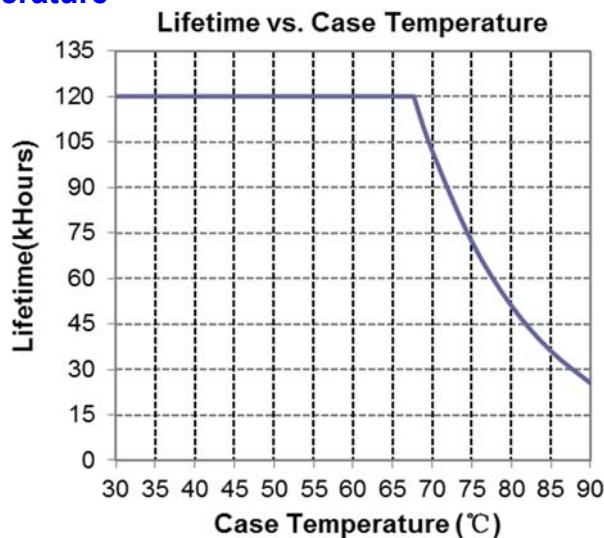

Inrush Current Waveform

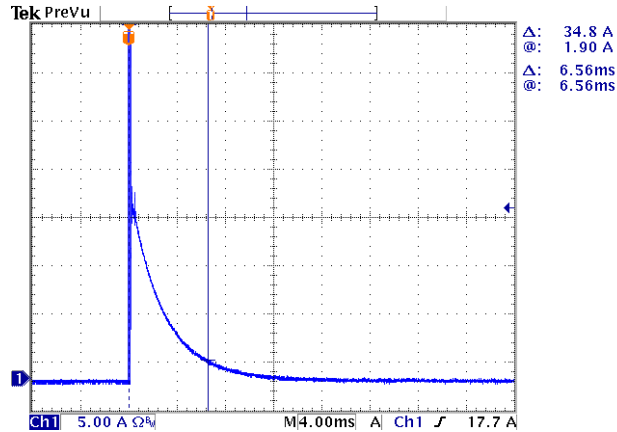

Efficiency vs. Load

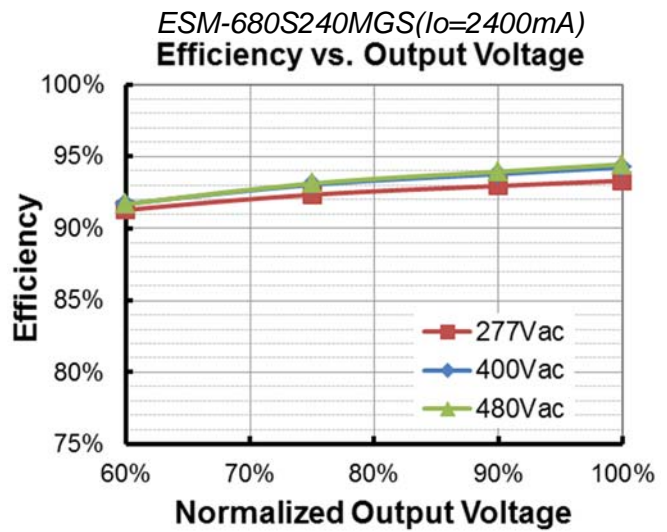
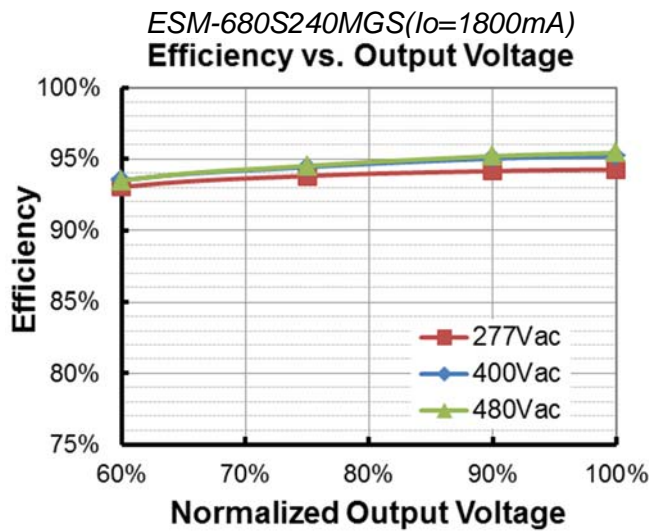
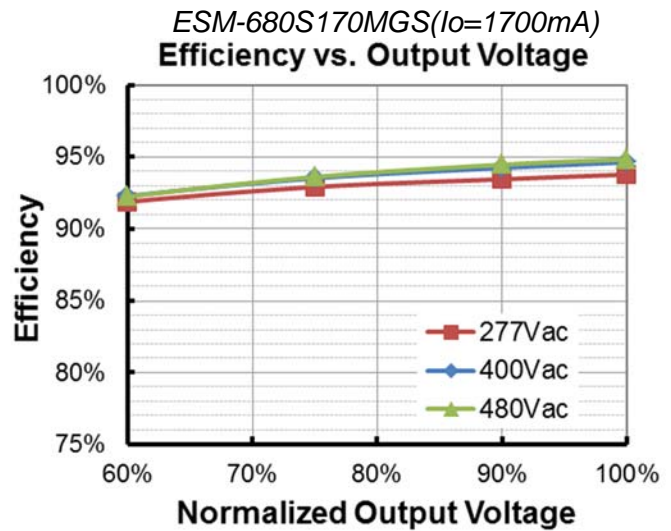
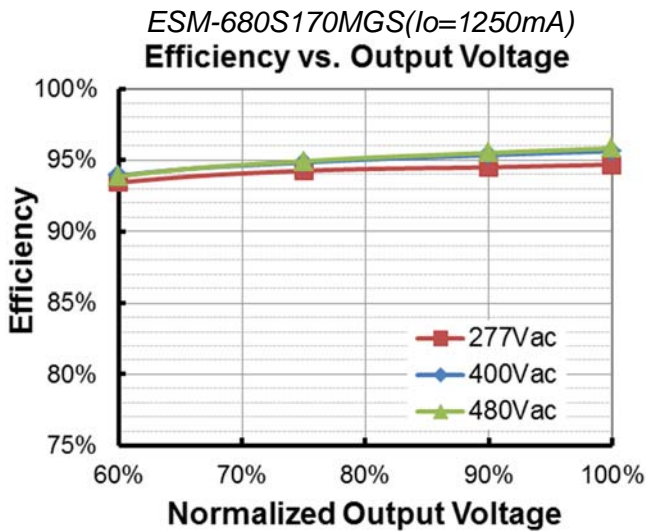

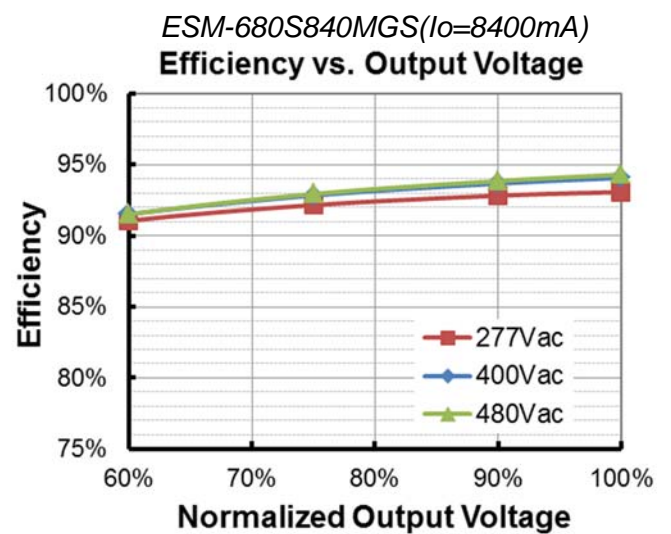
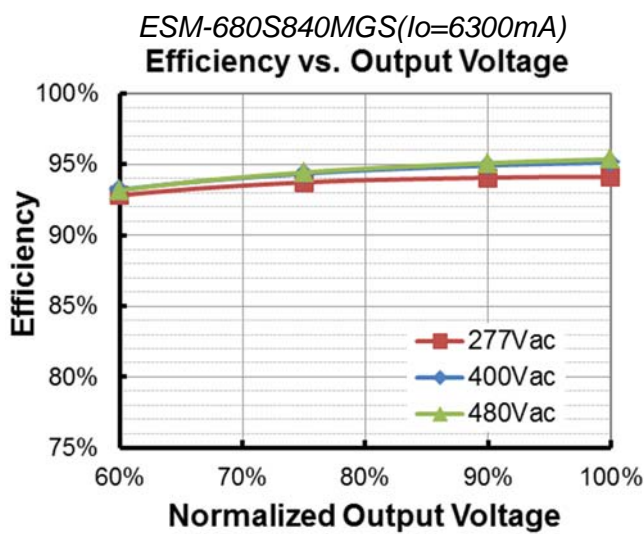
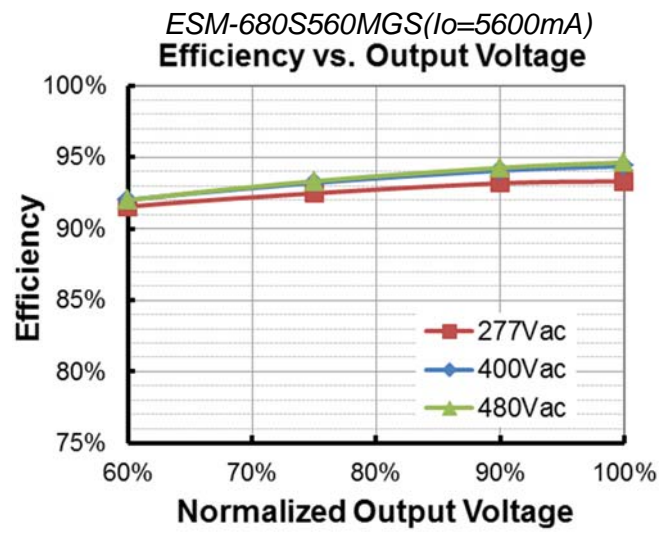
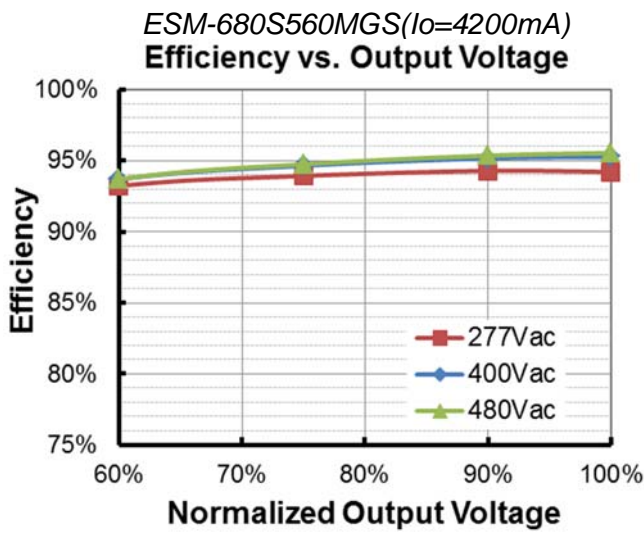
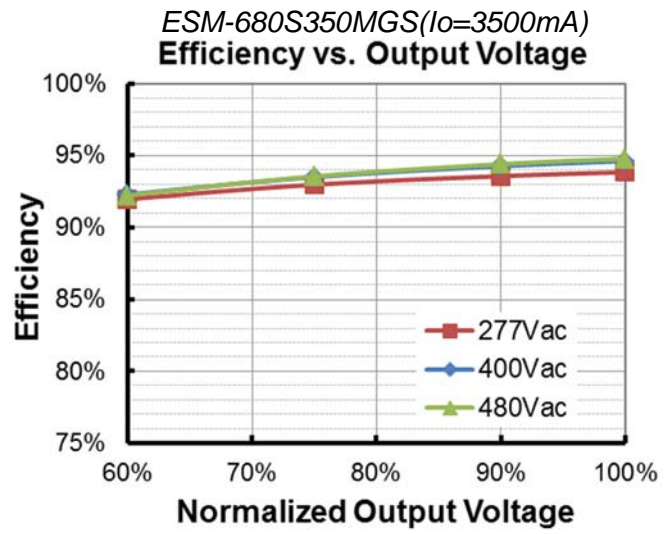
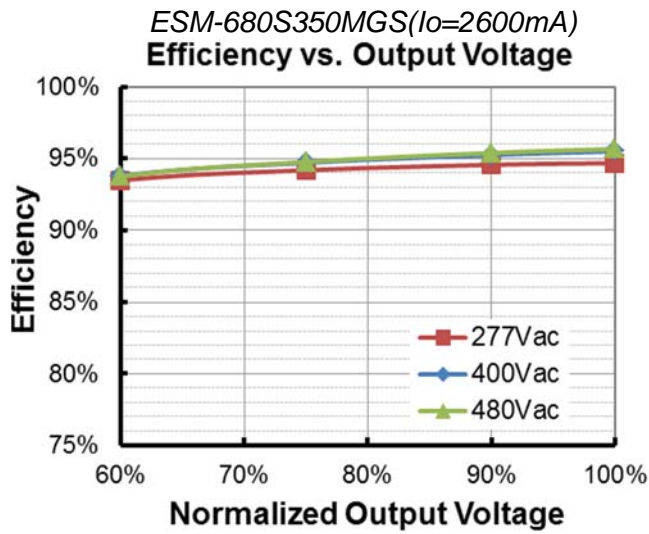

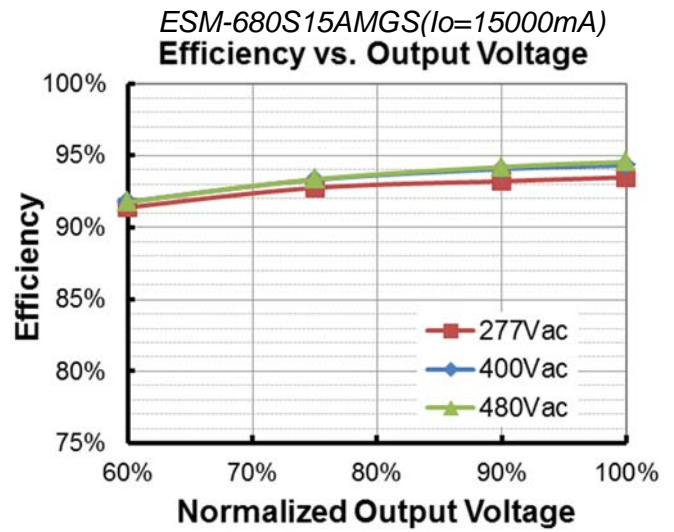
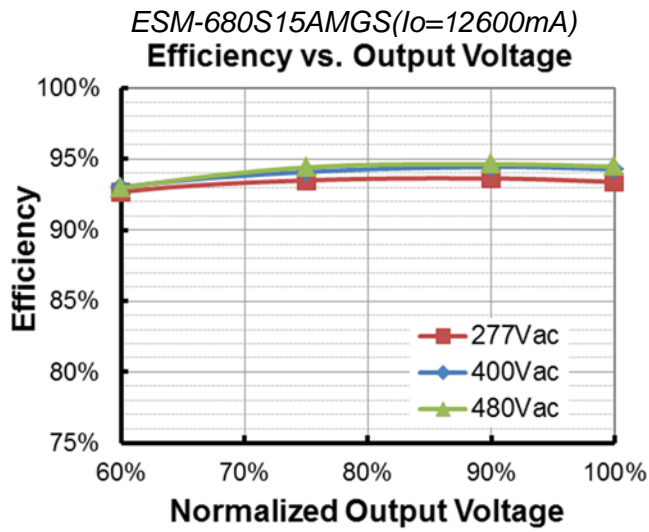

Power Factor

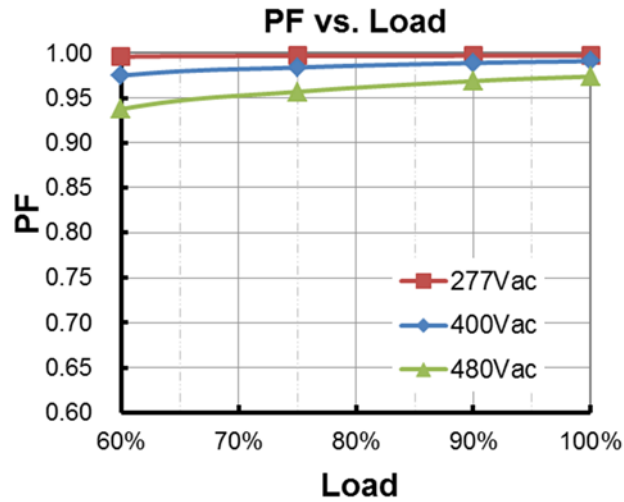

Total Harmonic Distortion

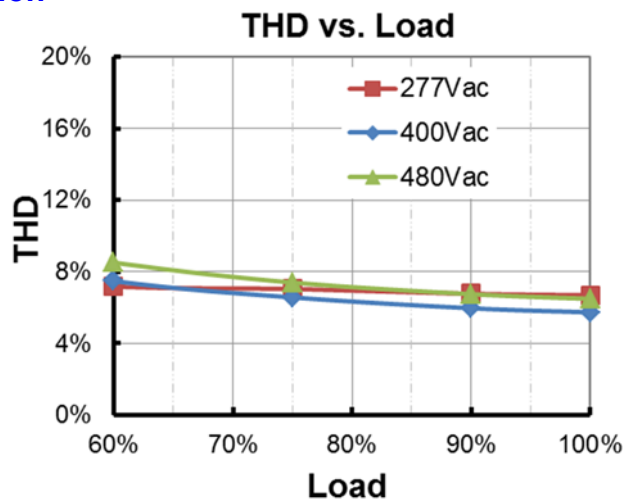

Protection Functions

Parameter		Min.	Typ.	Max.	Notes
Over Temperature Protection		Decreases output current, returning to normal after over temperature is removed.			
Short Circuit Protection		Auto Recovery. No damage will occur when any output is short circuited. The output shall return to normal when the fault condition is removed.			
Over Voltage Protection		Limits output voltage at no load and in case the normal voltage limit fails.			
Input Under Voltage Protection (IUVP)	Input Protection Voltage	220 Vac	230 Vac	240 Vac	Turn off the output when the input voltage falls below protection voltage.
	Input Recovery Voltage	230 Vac	240 Vac	250 Vac	Auto Recovery. The driver will restart when the input voltage exceeds recovery voltage.
Input Over Voltage Protection (IOVP)	Input Over Voltage Protection	550 Vac	570 Vac	590 Vac	Turn off the output when the input voltage exceeds protection voltage.
	Input Over Voltage Recovery	530 Vac	550 Vac	570 Vac	Auto Recovery. The driver will restart when the input voltage falls below recovery voltage.
	Max. of Input Over Voltage	-	-	590 Vac	The driver can survive for 8 hours with a stable input voltage stress of 590Vac.

● Input Under Voltage Protection Diagram

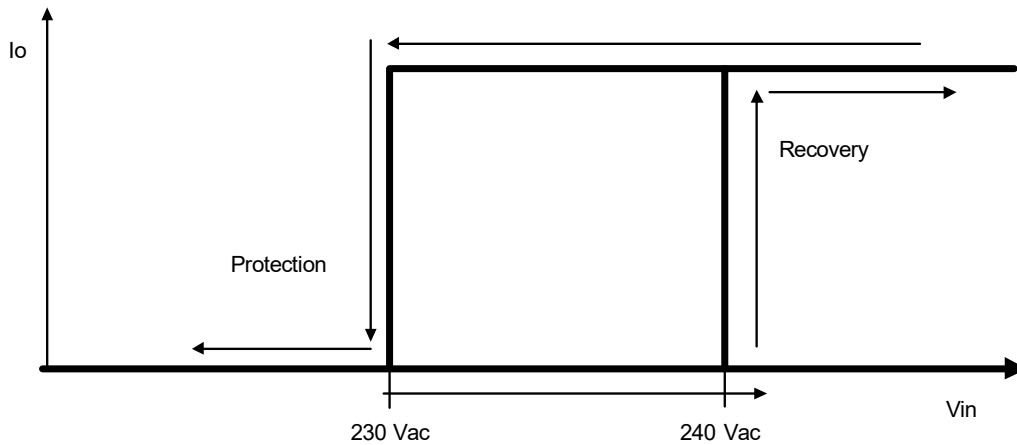

● Input Over Voltage Protection Diagram

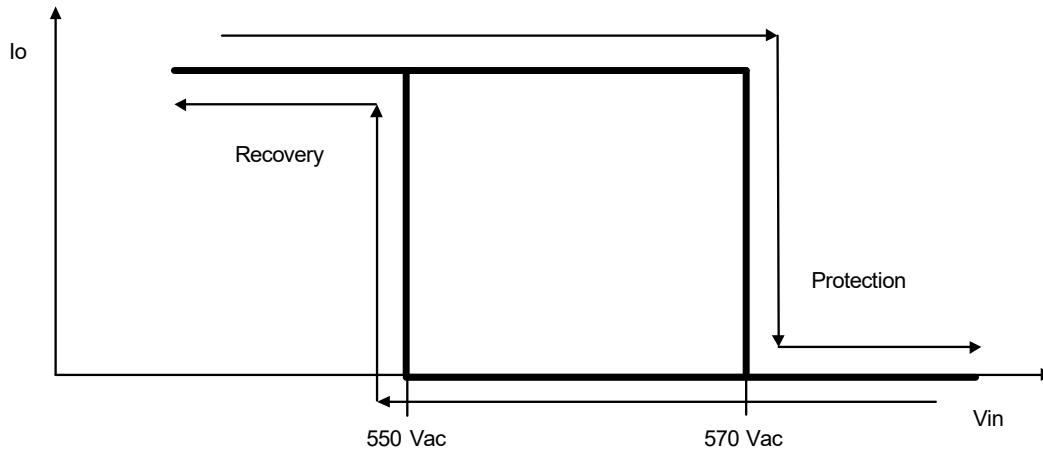

Dimming

● 0-10V Dimming

The recommended implementation of the dimming control is provided below.

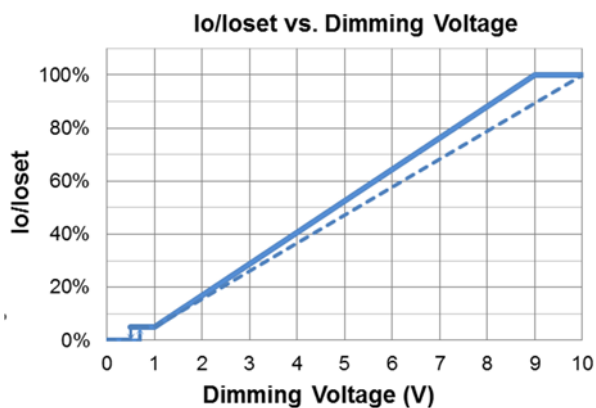
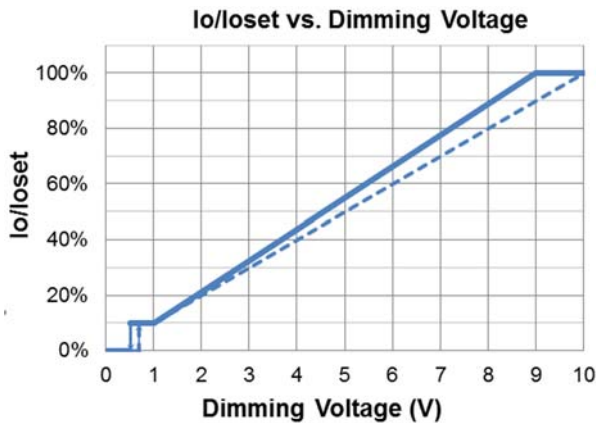
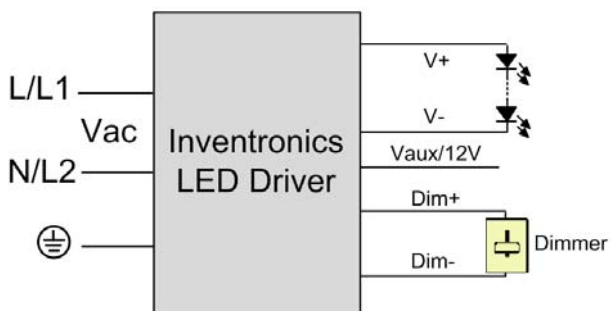

Implementation 1: Positive logic

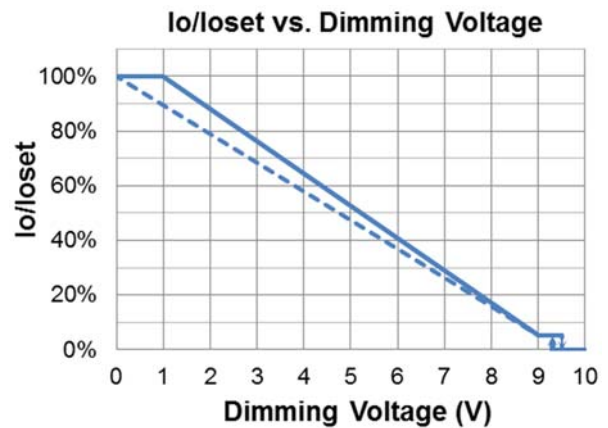
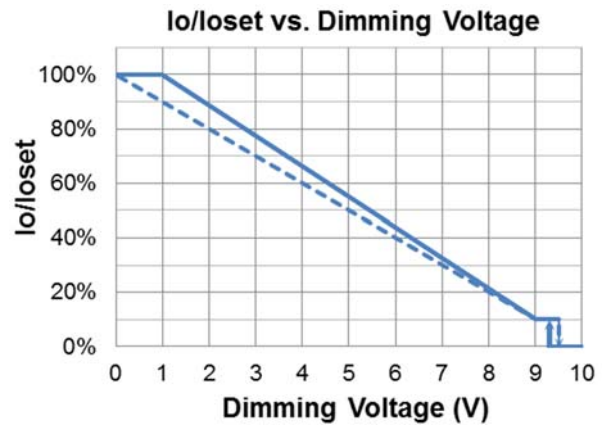
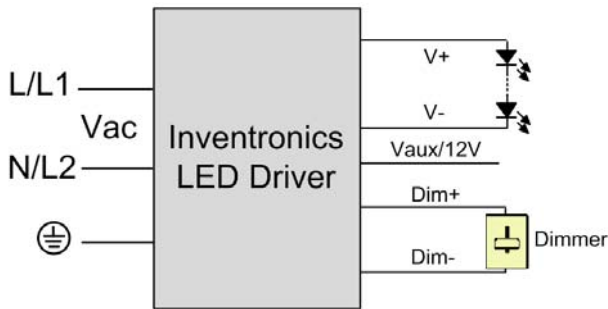

Implementation 2: Negative logic

Notes:

1. Do NOT connect Dim- to the output V- or V+, otherwise the driver will not work properly.
2. The dimmer can also be replaced by an active 0-10V voltage source signal or passive components like zener.
3. When 0-10V negative logic dimming mode and Dim+ is open, the driver will dim to off and be standby.

● **PWM Dimming**

The recommended implementation of the dimming control is provided below.

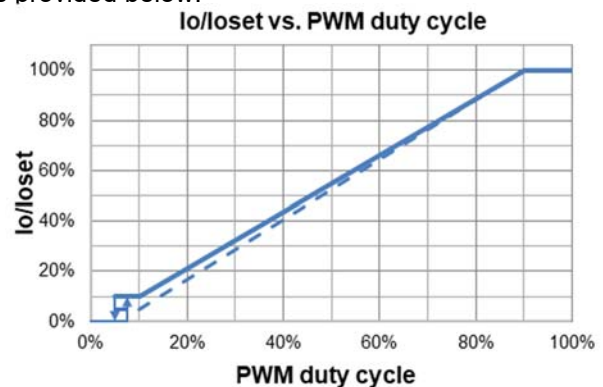
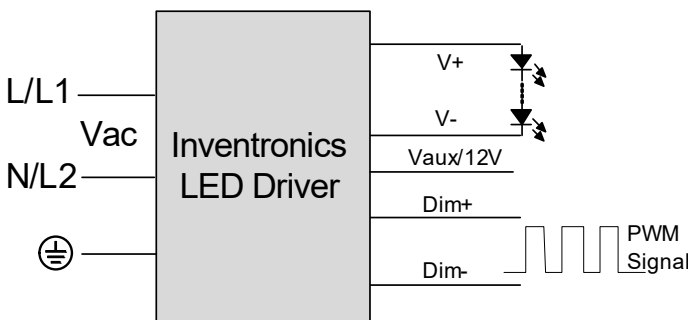

Implementation 3: Positive logic

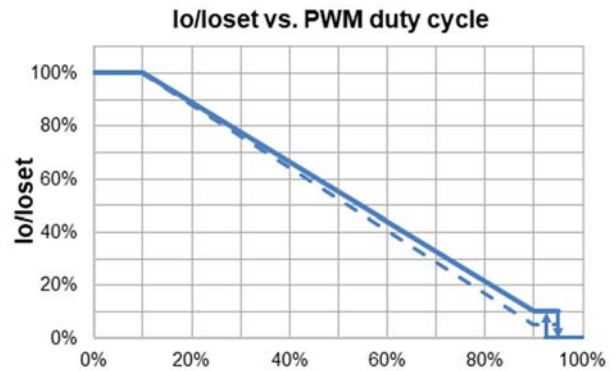
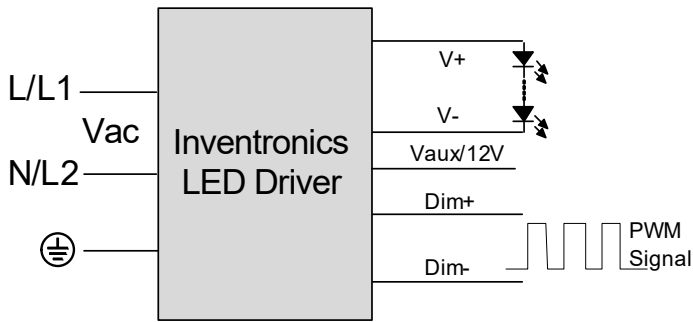

Implementation 4: Negative logic PWM duty cycle

Notes:

1. Do NOT connect Dim- to the output V- or V+, otherwise the driver will not work properly.
2. When PWM negative logic dimming mode and Dim+ is open, the driver will dim to off and be standby.

● **Time Dimming**

Time dimming control includes 3 kinds of modes, they are Self Adapting-Midnight, Self Adapting-Percentage and Traditional Timer.

- **Self Adapting-Midnight:** Automatically adjusts the dimming curve based on the on-time of past two days (if difference <15 minutes), assuming that the center point of the dimming curve is midnight local time.
- **Self Adapting-Percentage:** Automatically adjusts the on-time of each step by a constant percentage = (actual on-time for the past 2 days if difference <15 min) / (programmed on-time from the dimming curve).
- **Traditional Timer:** Follows the programmed timing curve after power on with no changes.

● **Output Lumen Compensation**

Output Lumen Compensation (OLC) may be used to maintain constant light output over the life of the LEDs by driving them at a reduced current when new, then gradually increasing the drive current over time to counteract LED lumen degradation.

● **Minimum Dimming Level with 5% or 10% Selectable**

The minimum dimming level can be set as 5% or 10% by Inventronics Multi Programmer, 10% is default.

● **Maximum Dimming Level with 9V or 10V Selectable**

The maximum dimming level can be set as corresponding dimming voltage is 9V or 10V by Inventronics Multi Programmer, 9V is default.

● **Fade Time Adjustable**

Soft-start time and dimming slope can be adjusted by Inventronics Multi Programmer to get customized fade time experience, disable mode is default.

● **End Of Life**

End-of-Life (EOL) is providing a visual notification to a user that the LED module has reached the end of manufacturer-specified life and that the replacement is recommended. Once active, an indication is given at each power-up of the driver, which the driver indicates this through a lower light output during the first 1 minute before normal operation is continued.

● **Digital Dimming**

Inventronics Digital Dimming is a UART (Universal Asynchronous Receive Transmitter) based communication protocol. Please refer to [Inventronics Digital Dimming](#) file for details.

Programming Connection Diagram

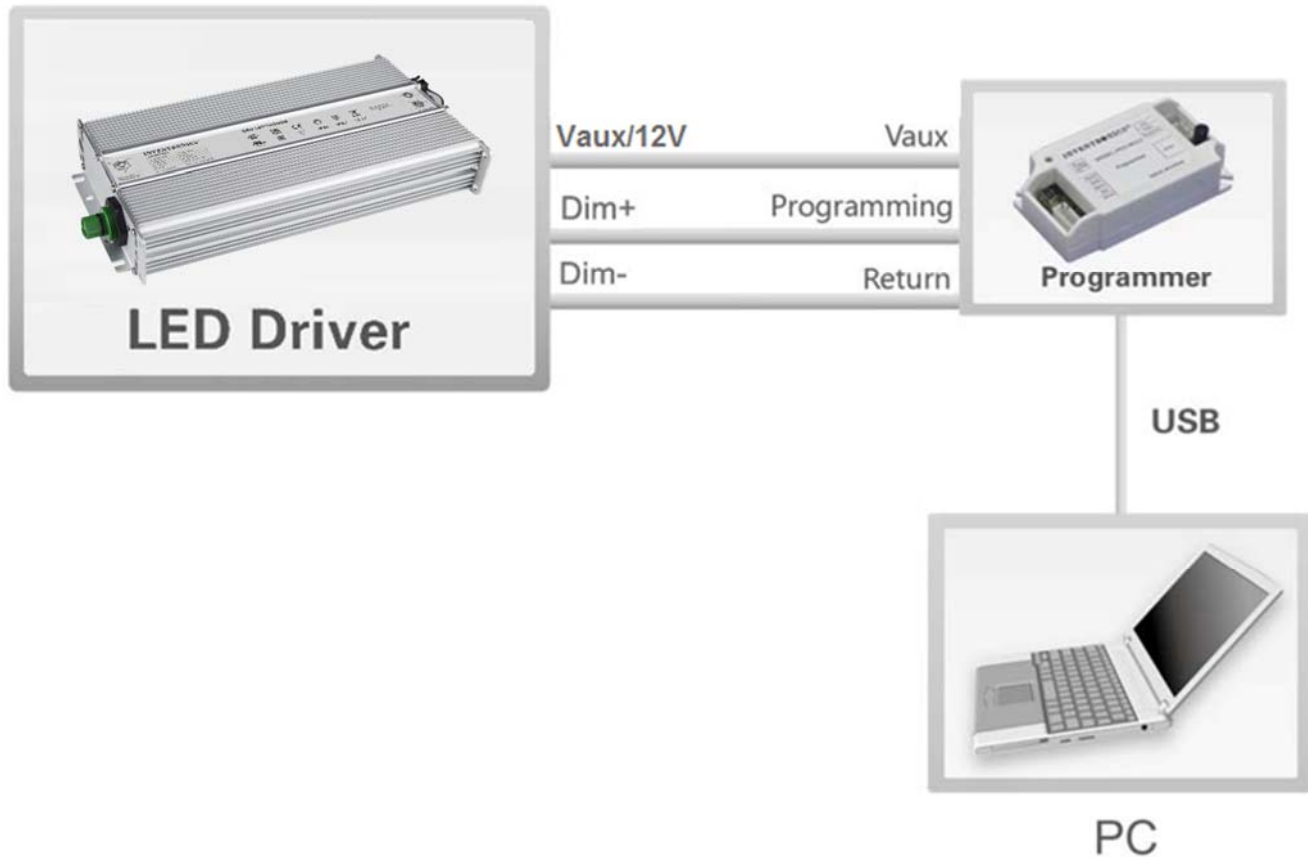

Note: The driver does not need to be powered on during the programming process.

- Please refer to [PRG-MUL2](#) (Programmer) datasheet for details.

Mechanical Outline

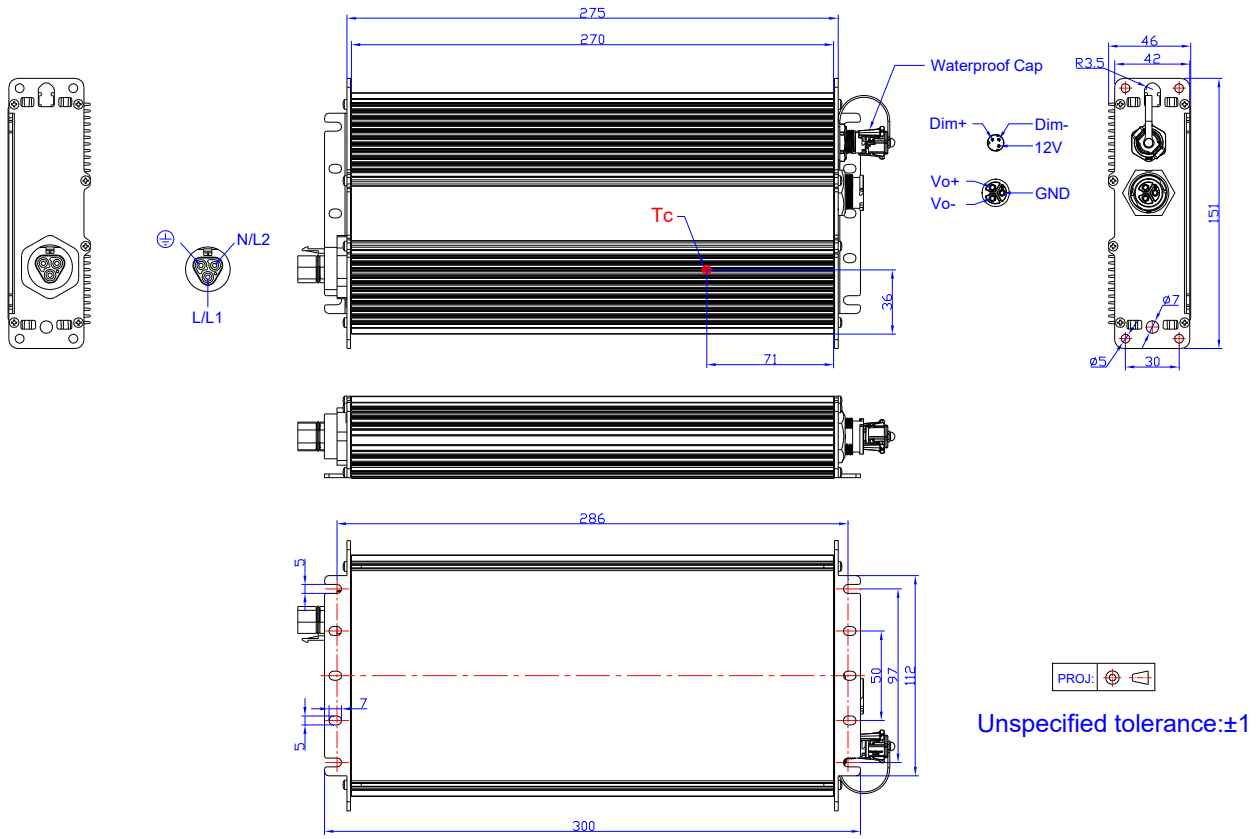

Note: This driver features UL Wet Location, IP67 panel mount connectors to streamline wiring in the field while still supporting stringent environmental conditions. The mating push-lock are not supplied by Inventronics. Please contact Wieland and Amphenol LTW or one of their suppliers for assistance sourcing the mating push-lock

Location	Series	Application	PN of connector on driver	PN of mating push-lock
Vin	Wieland RST20i3	600V/5A	96.032.1055.7	96.031.0055.7 (Spring) or 96.031.4055.7 (Screw)
		600V/10A	96.032.5055.7	
Vo	ALTW X-Lok,C-Size	600V/10A	ABAB-CAQ03000091	CC-03BFMB-QL8APA
		300V/20A	ABAB-CAQ03000100	CC-03BFMB-QL8APP
Dim	ALTW X-Lok,A-Size	300V/5A	ABAB-AMQ03000091	AD-03BFFB-QL8AP0
Dim	ALTW X-Lok,A-Size Waterproof Cap	/	CAP-WAAMQPC1	/

RoHS Compliance

Our products comply with reference to RoHS Directive (EU) 2015/863 amending 2011/65/EU, calling for the elimination of lead and other hazardous substances from electronic products.

Revision History

Change Date	Rev.	Description of Change		
		Item	From	To
2021-09-02	A	Datasheet Release	/	/
2022-03-10	B	Product Photograph	/	Updated
		UKCA/EAC logo	/	Added
		Safety &EMC Compliance	/	Updated
		PWM Dimming	/	Updated