

ALF G1

LED Area Light Selectable **CONTRACTOR XP**

Due to continuous product improvements, specification and/or equipment updates may change without notice.



(Images are shown for illustration purposes only)



ALF Medium Medium Selectable Area Light
(Pictured with Adjustable Pole Mount)



ALF Large Large Selectable Area Light
(Pictured with Adjustable Pole Mount)

SPECIFICATIONS

<p>Housing One-piece, die-cast aluminum housing sealed against moisture and environmental contaminants - features PIN receptacle.</p>	<p>Mounting Square/Round Pole and Slipfitter Mounting options.</p>	<p>Lumen Output Medium Area Light Field selectable: 10,000 - 23,000 Lm. Large Area Light Field selectable: LS450 model: 20,000 - 45,000 Lm. LS600 model: 47,000 - 60,500 Lm.</p>	<p>Electrical Standard 120-277 VAC HVU Option 277-480 VAC 0-10 V dimming driver.</p>	<p>Warranty 5-year limited warranty. Comprehensive warranty terms can be located on www.slgus.com.</p>	<p>Certifications UL Listed. IP65 rated. FCC compliant. Design Lights Consortium® (DLC) 5.1 Premium qualified product.</p>
<p>Ambient Temperature Suitable for use in -40° C to 45° C (-40° F to 113° F). LS600 Model: -40° C to 40° C (-40° F to 104° F).</p>	<p>Efficacy Up to 162 lumens per watt.</p>		<p>Full Cutoff Full cutoff luminaire when installed at a level 90° angle to the ground.</p>	<p>Optics Available in IES Type II, III, IV, and V distributions. Polycarbonate lens. Can conform to dark sky requirements.</p>	<p>Lifespan L70 > 72,000 hours @ 25° C</p>
	<p>CCT and CRI Field selectable: 3000K, 4000K, and 5000K - 70 CRI</p>				

ORDERING GUIDE

Example: ALF LS220 T3 G1 FSK PSC ASR

Fixture	Selectable Lumen Output	Distribution	Generation	Voltage	Selectable CCT	Photocell	Included Mount	Finish	Controls (Optional)	Accessories
• ALF LED Area Light-Flexible	<ul style="list-style-type: none"> • LS230 10,000 Lm / 60 W 15,500 Lm / 85 W 20,000 Lm / 110 W 23,000 Lm / 140 W • LS450 20,000 Lm / 120 W 28,500 Lm / 180 W 38,500 Lm / 240 W 45,000 Lm / 300 W • LS600[Ⓛ] 47,000 Lm / 300 W 51,000 Lm / 320 W 56,000 Lm / 360 W 60,500 Lm / 400 W 	<ul style="list-style-type: none"> • T2 Type II • T3 Type III • T4 Type IV • T5 Type V 	<ul style="list-style-type: none"> • G1 First Generation 	<ul style="list-style-type: none"> • BLANK 120-277 V • HVU* 347-480 V 	<ul style="list-style-type: none"> • FSK 3000K 4000K 5000K 	<ul style="list-style-type: none"> PSC Ships with Photocell and Shorting Cap. BLANK Leave this blank when ordering HVU models - these do not include photocell and shorting cap. 	<ul style="list-style-type: none"> • ASR Adjustable Square and Round Pole Mount (ships in same box) • SFD Slipfitter Mount (ships in same box) 	<ul style="list-style-type: none"> • BLANK Dark Bronze • B Black • W White • SG Silver Gray • C** Custom Color 	<ul style="list-style-type: none"> • PC-2 Twist-lock Photocell (480V) OSLG sync • MSB-DCE-06-W-BT5.0 Bluetooth Plug-in Sensor/Controller - Photocell+PIR (MSB-20-L7-W NOT included) • MSB-DCE-06-W Bluetooth Sensor, Daylight Harvest+PIR • MSB-DCE-06-W L3 Medium Bay lens L7 High Bay lens • FCB-DCE-02-W Bluetooth Plug-in Controller Node Standalone Controls • MS-DCE-09-W Standalone Motion Sensor • RM06 Remote controller for standalone motion sensor 	<ul style="list-style-type: none"> • ALF-M-EGS External glare shield for ALF LS230 (available in Dark bronze, black, silver, and white) • ALF-L-EGS External glare shield for ALF LS450 / LS600 (available in Dark bronze, black, silver, and white) • ALF-M-HGS Housing side glare shield for ALF LS230 (available in Dark bronze, black, silver, and white) • ALF-L-HGS Housing side glare shield for ALF LS450 / LS600 (available in Dark bronze, black, silver, and white) • ALF-M-BLS Back light control for ALF LS230 • ALF-L-BLS Back light control for ALF LS450 / LS600

* HVU option does not ship with PIN receptacle, Photocell, shorting cap, or ASR mount.

**For a custom color, please call to place your order.

Ⓛ ALF LS600 model is 4000K/5000K switch selectable.

CATALOGUE



DARK BRONZE 120-277V

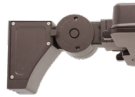

Adjustable Pole mount

Catalog Number	Dist.	Description	Lumens	Watts	CCT	Voltage	Mount
ALF LS230 T3 G1 FSK PSC ASR	T3	Area Light - 4 Level Wattage Adjustable, Gen1, With 3 Pin Photocell & Shorting Cap	Selectable 10,000 - 23,000 Lm	Selectable 60 - 140W	Selectable 3000K - 5000K	120-277V	Included Adjustable Pole Mount
ALF LS230 T4 G1 FSK PSC ASR	T4	Area Light - 4 Level Wattage Adjustable, Gen1, With 3 Pin Photocell & Shorting Cap	Selectable 10,000 - 23,000 Lm	Selectable 60 - 140W	Selectable 3000K - 5000K	120-277V	Included Adjustable Pole Mount
ALF LS230 T5 G1 FSK PSC ASR	T5	Area Light - 4 Level Wattage Adjustable, Gen1, With 3 Pin Photocell & Shorting Cap	Selectable 10,000 - 23,000 Lm	Selectable 60 - 140W	Selectable 3000K - 5000K	120-277V	Included Adjustable Pole Mount
ALF LS450 T3 G1 FSK PSC ASR	T3	Area Light - 4 Level Wattage Adjustable, Gen1, With 3 Pin Photocell & Shorting Cap	Selectable 20,000 - 45,000 Lm	Selectable 120 - 300W	Selectable 3000K - 5000K	120-277V	Included Adjustable Pole Mount
ALF LS450 T4 G1 FSK PSC ASR	T4	Area Light - 4 Level Wattage Adjustable, Gen1, With 3 Pin Photocell & Shorting Cap	Selectable 20,000 - 45,000 Lm	Selectable 120 - 300W	Selectable 3000K - 5000K	120-277V	Included Adjustable Pole Mount
ALF LS450 T5 G1 FSK PSC ASR	T5	Area Light - 4 Level Wattage Adjustable, Gen1, With 3 Pin Photocell & Shorting Cap	Selectable 20,000 - 45,000 Lm	Selectable 120 - 300W	Selectable 3000K - 5000K	120-277V	Included Adjustable Pole Mount
ALF LS600 T3 G1 FSK PSC ASR	T3	Area Light - 4 Level Wattage Adjustable, Gen1, With 3 Pin Photocell & Shorting Cap	Selectable 47,000 - 60,500 Lm	Selectable 300 - 400W	Selectable 4000K - 5000K	120-277V	Included Adjustable Pole Mount
ALF LS600 T4 G1 FSK PSC ASR	T4	Area Light - 4 Level Wattage Adjustable, Gen1, With 3 Pin Photocell & Shorting Cap	Selectable 47,000 - 60,500 Lm	Selectable 300 - 400W	Selectable 4000K - 5000K	120-277V	Included Adjustable Pole Mount
ALF LS600 T5 G1 FSK PSC ASR	T5	Area Light - 4 Level Wattage Adjustable, Gen1, With 3 Pin Photocell & Shorting Cap	Selectable 47,000 - 60,500 Lm	Selectable 300 - 400W	Selectable 4000K - 5000K	120-277V	Included Adjustable Pole Mount



Slipfitter mount

Catalog Number	Dist.	Description	Lumens	Watts	CCT	Voltage	Mount
ALF LS230 T3 G1 FSK PSC SFD	T3	Area Light - 4 Level Wattage Adjustable, Gen1, With 3 Pin Photocell & Shorting Cap	Selectable 10,000 - 23,000 Lm	Selectable 60 - 140W	Selectable 3000K - 5000K	120V-277V	Included Slipfitter Mount
ALF LS450 T3 G1 FSK PSC SFD	T3	Area Light - 4 Level Wattage Adjustable, Gen1, With 3 Pin Photocell & Shorting Cap	Selectable 20,000 - 45,000 Lm	Selectable 120 - 300W	Selectable 3000K - 5000K	120-277V	Included Slipfitter Mount
ALF LS230 T4 G1 FSK PSC SFD	T4	Area Light - 4 Level Wattage Adjustable, T4, Gen1, With 3 Pin Photocell & Shorting Cap	Selectable 10,000 - 23,000 Lm	Selectable 60 - 140W	Selectable 3000K - 5000K	120-277V	Included Slipfitter Mount
ALF LS230 T5 G1 FSK PSC SFD	T5	Area Light - 4 Level Wattage Adjustable, T5, Gen1, With 3 Pin Photocell & Shorting Cap	Selectable 10,000 - 23,000 Lm	Selectable 60 - 140W	Selectable 3000K - 5000K	120-277V	Included Slipfitter Mount
ALF LS450 T4 G1 FSK PSC SFD	T4	Area Light - 4 Level Wattage Adjustable, T4, Gen1, With 3 Pin Photocell & Shorting Cap	Selectable 20,000 - 45,000 Lm	Selectable 120 - 300W	Selectable 3000K - 5000K	120-277V	Included Slipfitter Mount
ALF LS450 T5 G1 FSK PSC SFD	T5	Area Light - 4 Level Wattage Adjustable, Gen1, With 3 Pin Photocell & Shorting Cap	Selectable 20,000 - 45,000 Lm	Selectable 120 - 300W	Selectable 3000K - 5000K	120-277V	Included Slipfitter Mount
ALF LS600 T3 G1 FSK PSC SFD	T3	Area Light - 4 Level Wattage Adjustable, Gen1, With 3 Pin Photocell & Shorting Cap	Selectable 47,000 - 60,500 Lm	Selectable 300 - 400W	Selectable 4000K - 5000K	120-277V	Included Slipfitter Mount
ALF LS600 T4 G1 FSK PSC SFD	T4	Area Light - 4 Level Wattage Adjustable, Gen1, With 3 Pin Photocell & Shorting Cap	Selectable 47,000 - 60,500 Lm	Selectable 300 - 400W	Selectable 4000K - 5000K	120-277V	Included Slipfitter Mount
ALF LS600 T5 G1 FSK PSC SFD	T5	Area Light - 4 Level Wattage Adjustable, Gen1, With 3 Pin Photocell & Shorting Cap	Selectable 47,000 - 60,500 Lm	Selectable 300 - 400W	Selectable 4000K - 5000K	120-277V	Included Slipfitter Mount

DARK BRONZE HVU 277-480V

Catalog Number	Dist.	Description	Lumens	Watts	CCT	Voltage	Mount
ALF LS230 T3 G1 HVU FSK	T3	Area Light - 4 Level Wattage Adjustable, Gen1, High Voltage	Selectable 10,000 - 23,000 Lm	Selectable 60 - 140W	Selectable 3000K - 5000K	277 - 480V	NOT INCLUDED
ALF LS450 T3 G1 HVU FSK	T3	Area Light - 4 Level Wattage Adjustable, Gen1, High Voltage	Selectable 20,000 - 45,000 Lm	Selectable 120 - 300W	Selectable 3000K - 5000K	277 - 480V	NOT INCLUDED
ALF LS600 T3 G1 HVU FSK	T3	Area Light - 4 Level Wattage Adjustable, Gen1, High Voltage	Selectable 47,000 - 60,500 Lm	Selectable 300 - 400W	Selectable 4000K - 5000K	277 - 480V	NOT INCLUDED

ALF G1



WHITE 120-277V

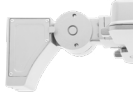

Adjustable Pole mount



Slipfitter mount

Catalog Number	Dist.	Description	Lumens	Watts	CCT	Voltage	Mount
ALF LS230 T3 G1FSK PSC ASR W	T3	Area Light - 4 Level Wattage Adjustable, Gen1, With 3 Pin Photocell & Shorting Cap, White	Selectable 10,000 - 23,000 Lm	Selectable 60 - 140W	Selectable 3000K - 5000K	120-277V	Included Adjustable Pole Mount
ALF LS450 T3 G1FSK PSC ASR W	T3	Area Light - 4 Level Wattage Adjustable, Gen1, With 3 Pin Photocell & Shorting Cap, White	Selectable 20,000 - 45,000 Lm	Selectable 120 - 300W	Selectable 3000K - 5000K	120-277V	Included Adjustable Pole Mount
ALF LS600 T3 G1FSK PSC ASR W	T3	Area Light - 4 Level Wattage Adjustable, Gen1, With 3 Pin Photocell & Shorting Cap, White	Selectable 47,000 - 60,500 Lm	Selectable 300 - 400W	Selectable 4000K - 5000K	120-277V	Included Adjustable Pole Mount
ALF LS230 T3 G1FSK PSC SFD W	T3	Area Light - 4 Level Wattage Adjustable, Gen1, With 3 Pin Photocell & Shorting Cap, White	Selectable 10,000 - 23,000 Lm	Selectable 60 - 140W	Selectable 3000K - 5000K	120-277V	Included Slipfitter Mount
ALF LS450 T3 G1FSK PSC SFD W	T3	Area Light - 4 Level Wattage Adjustable, Gen1, With 3 Pin Photocell & Shorting Cap, White	Selectable 20,000 - 45,000 Lm	Selectable 120 - 300W	Selectable 3000K - 5000K	120-277V	Included Slipfitter Mount



BLACK 120-277V



Adjustable Pole mount

Catalog Number	Dist.	Description	Lumens	Watts	CCT	Voltage	Mount
ALF LS230 T3 G1FSK PSC ASR B	T3	Area Light - 4 Level Wattage Adjustable, Gen1, With 3 Pin Photocell & Shorting Cap, Black	Selectable 10,000 - 23,000 Lm	Selectable 60 - 140W	Selectable 3000K - 5000K	120-277V	Included Adjustable Pole Mount
ALF LS450 T3 G1FSK PSC ASR B	T3	Area Light - 4 Level Wattage Adjustable, Gen1, With 3 Pin Photocell & Shorting Cap, Black	Selectable 20,000 - 45,000 Lm	Selectable 120 - 300W	Selectable 3000K - 5000K	120-277V	Included Adjustable Pole Mount
ALF LS600 T3 G1FSK PSC ASR B	T3	Area Light - 4 Level Wattage Adjustable, Gen1, With 3 Pin Photocell & Shorting Cap, Black	Selectable 47,000 - 60,500 Lm	Selectable 300 - 400W	Selectable 4000K - 5000K	120-277V	Included Adjustable Pole Mount



SILVER GREY 120-277V

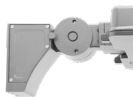

Adjustable Pole mount

Catalog Number	Dist.	Description	Lumens	Watts	CCT	Voltage	Mount
ALF LS230 T3 G1FSK PSC ASR SG	T3	Area Light - 4 Level Wattage Adjustable, Gen1, With 3 Pin Photocell & Shorting Cap, Silver Grey	Selectable 10,000 - 23,000 Lm	Selectable 60 - 140W	Selectable 3000K - 5000K	120-277V	Included Adjustable Pole Mount
ALF LS450 T3 G1FSK PSC ASR SG	T3	Area Light - 4 Level Wattage Adjustable, Gen1, With 3 Pin Photocell & Shorting Cap, Silver Grey	Selectable 20,000 - 45,000 Lm	Selectable 120 - 300W	Selectable 3000K - 5000K	120-277V	Included Adjustable Pole Mount
ALF LS600 T3 G1FSK PSC ASR SG	T3	Area Light - 4 Level Wattage Adjustable, Gen1, With 3 Pin Photocell & Shorting Cap, Silver Grey	Selectable 47,000 - 60,500 Lm	Selectable 300 - 400W	Selectable 4000K - 5000K	120-277V	Included Adjustable Pole Mount

Type II and additional options available upon special request.

ALF DIMENSIONS

ALF LS230 W/ Adjustable Pole Mount

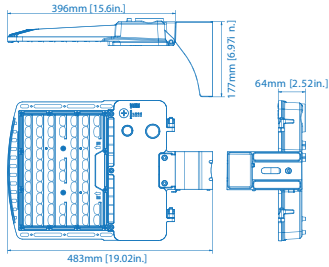

ALF LS450/LS600 W/ Adjustable Pole Mount

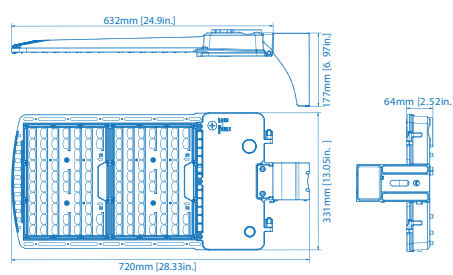

ALF LS230 W/ Adjustable Slipfitter Mount

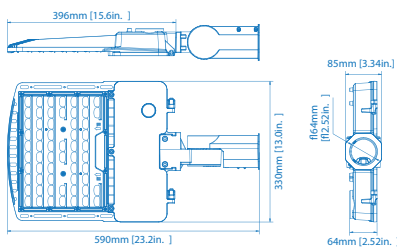

ALF LS450/LS600 W/ Adjustable Slipfitter Mount

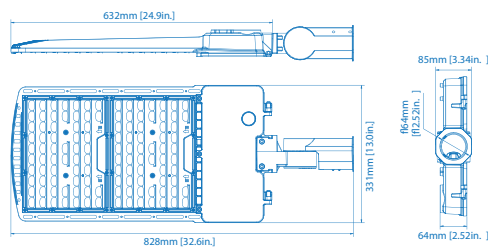

ALF LS230 W/ Wall Mount

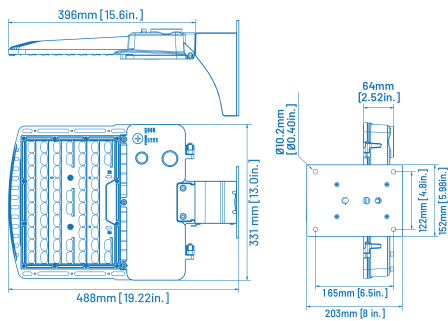

ALF LS450/LS600 W/ Wall Mount

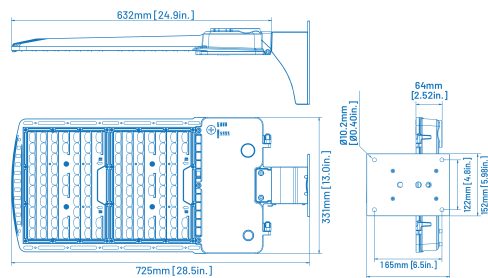

ALF LS230 W/ Trunnion Mount

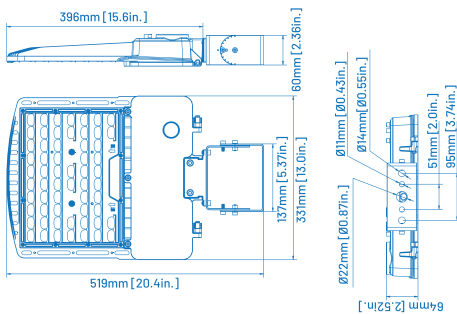

ALF LS450/LS600 W/ Trunnion Mount

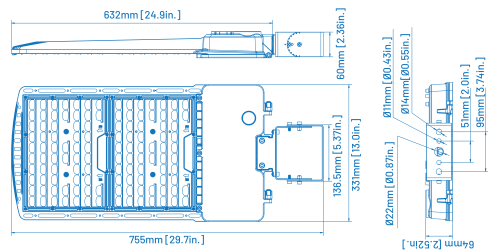

ALF G1



MOUNTING DIMENSIONS

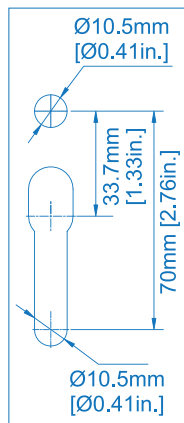
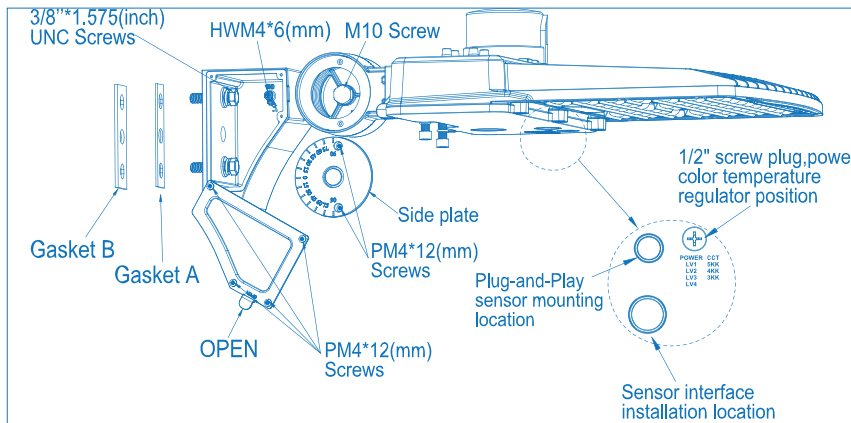

ASR
Adjustable Square and Round Pole Mount



ALC-SPAR



SFD
Slipfitter Mount



ALC-WMB



ALC-T

PHOTOMETRIC

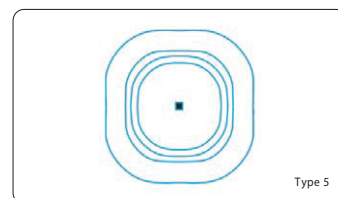
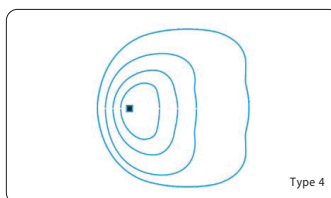
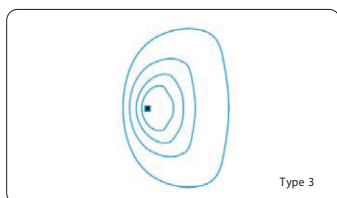
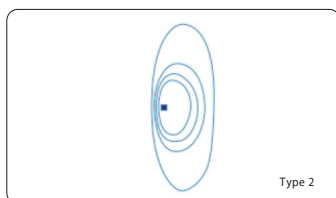

ALF G1



ELECTRICAL LOAD

	Power Setting	Wattage	Current (A)					Current (A)	
			120V	208V	240V	277V		347V	480V
ALF LS230	Low	60 W	0.5	0.29	0.29	0.22	ALF LS230 HVU	0.17	0.13
	Med	85 W	0.71	0.41	0.41	0.31		0.24	0.18
	High	110 W	0.92	0.53	0.53	0.4		0.32	0.23
	Max	140 W	1.17	0.67	0.67	0.51		0.4	0.29
ALF LS450	Low	120 W	1	0.58	0.5	0.43	ALF LS450 HVU	0.35	0.25
	Med	180 W	1.5	0.87	0.75	0.65		0.52	0.38
	High	240 W	2	1.15	1	0.87		0.69	0.5
	Max	300 W	2.5	1.44	1.25	1.08		0.86	0.63
ALF LS600	Low	300 W	2.5	1.4	1.25	1.1	ALF LS600 HVU	0.86	0.63
	Med	320 W	2.7	1.5	1.3	1.2		0.92	0.67
	High	360 W	3	1.7	1.5	1.3		1	0.75
	Max	400 W	3.3	1.9	1.7	1.4		1.2	0.83

EPA OF AREA LIGHT

ITEM							
140W	0.3632	0.6849	0.8861	0.7264	1.0481	1.2078	1.0481
300W / 400W	0.4758	0.8091	1.059	0.9516	1.2849	1.3923	1.2849

BUG @5000K

MODEL #	SYSTEM WATTS	VOLTAGE	DIST. TYPE	B	U	G
ALF LS230 T3	140W	120-277V / 277-480V	III	3	0	3
ALF LS450 T3	300W	120-277V / 277-480V	III	4	0	4
ALF LS600 T3	400W	120-277V / 277-480V	III	5	0	5

ALF G1



PERFORMANCE

Series Number	Power Percentage	Wattage	DIST. TYPE	CRI	3000K		4000K		5000K	
					LUMENS	LPW	LUMENS	LPW	LUMENS	LPW
ALF LS230	100%	140 W	III	70	19,200 Lm	143 Lm/W	23,000 Lm	164 Lm/W	21,000 Lm	150 Lm/W
	80%	120 W	III	70	18,000 Lm	150 Lm/W	20,000 Lm	167 Lm/W	18,500 Lm	154 Lm/W
	60%	90 W	III	70	14,000 Lm	156 Lm/W	15,500 Lm	172 Lm/W	14,500 Lm	161 Lm/W
	40%	60 W	III	70	9,700 Lm	162 Lm/W	10,600 Lm	177 Lm/W	10,000 Lm	167 Lm/W
ALF LS450	100%	300 W	III	70	41,000 Lm	137 Lm/W	45,000 Lm	150 Lm/W	42,000 Lm	140 Lm/W
	80%	240 W	III	70	35,000 Lm	146 Lm/W	38,500 Lm	160 Lm/W	36,000 Lm	150 Lm/W
	60%	180 W	III	70	28,000 Lm	156 Lm/W	30,000 Lm	167 Lm/W	28,500 Lm	158 Lm/W
	40%	120 W	III	70	19,200 Lm	160 Lm/W	21,500 Lm	179 Lm/W	20,000 Lm	167 Lm/W
ALF LS600	100%	400 W	III	70	N/A	N/A	60,500 Lm	151 Lm/W	60,000 Lm	150 Lm/W
	80%	360 W	III	70			56,000 Lm	156 Lm/W	55,000 Lm	153 Lm/W
	60%	320 W	III	70			51,000 Lm	159 Lm/W	50,000 Lm	156 Lm/W
	40%	300 W	III	70			47,000 Lm	162 Lm/W	46,000 Lm	159 Lm/W

ACCESSORIES



PSC
Twist-lock Photocell (120-277V)
with shorting cap
(ship with all 120-277V ALF models)



PC-2
Twist-lock Photocell (480V)



MSB-DCE-06-W
Bluetooth Plug-in Controller/
Sensor



MS-DCE-09-W
Standalone Motion Sensor



FCB-DCE-02-W
Bluetooth Plug-in Node



DLC LISTED N-EPBK41



RM06
Remote for motion sensor



DLC LISTED N-EPBK41

GLARE SHIELDS



ALF-EGS
External Glare Shields



ALF-HGS
Housing Side
Glare Shields



ALF-BLS
Back light control

Catalog Number	Compatible Model	Finish
ALF-M-EGS	ALF LS230	Dark Bronze
ALF-M-EGS-W	ALF LS230	White
ALF-M-EGS-B	ALF LS230	Black
ALF-M-EGS-SG	ALF LS230	Silver Grey

Catalog Number	Compatible Model	Finish
ALF-L-EGS	ALF LS450 / LS800	Dark Bronze
ALF-L-EGS-W	ALF LS450 / LS800	White
ALF-L-EGS-B	ALF LS450 / LS800	Black
ALF-L-EGS-SG	ALF LS450 / LS800	Silver Grey

Catalog Number	Compatible Model	Finish
ALF-M-HGS	ALF LS230	Dark Bronze
ALF-M-HGS-W	ALF LS230	White
ALF-M-HGS-B	ALF LS230	Black
ALF-M-HGS-SG	ALF LS230	Silver Grey

Catalog Number	Compatible Model	Finish
ALF-L-HGS	ALF LS450 / LS800	Dark Bronze
ALF-L-HGS-W	ALF LS450 / LS800	White
ALF-L-HGS-B	ALF LS450 / LS800	Black
ALF-L-HGS-SG	ALF LS450 / LS800	Silver Grey

Catalog Number	Compatible Model
ALF-M-BLS	ALF LS230
ALF-L-BLS	ALF LS450 / LS800

PROJECTED LUMINAIRE MAINTENANCE

ALF LS230 G1 FSK (AT 140W)

LM-80 Testing Details	
Total number of units tested per case temp:	30
Number of failures:	0
Number of units measured:	30
Test duration (hours):	12,000
Tested drive current (mA):	120
Tested case temperature 1 (T _c , °C):	85
Tested case temperature 2 (T _c , °C):	105

Test Data for 85°C Case Temp	
Time (hours)	Lumen Maintenance (%)
0	100.00%
1,000	100.10%
2,000	99.87%
3,000	99.56%
4,000	99.14%
5,000	98.66%
6,000	98.24%
7,000	97.87%
8,000	97.54%
9,000	97.26%
10,000	96.93%
11,000	96.74%
12,000	96.58%

Test Data for 105°C Case Temp	
Time (hours)	Lumen Maintenance (%)
0	100.00%
1,000	99.68%
2,000	99.35%
3,000	98.90%
4,000	98.37%
5,000	97.81%
6,000	97.36%
7,000	96.94%
8,000	96.48%
9,000	96.01%
10,000	95.65%
11,000	95.10%
12,000	94.66%

Results	
Time (t) at which to estimate Lumen maintenance (hours):	50,000
Lumen maintenance at time (t) (%):	86.47%
Reported L70 (hours):	>72,000

ALF LS450 G1 FSK (AT 300W)

LM-80 Testing Details	
Total number of units tested per case temp:	30
Number of failures:	0
Number of units measured:	30
Test duration (hours):	12,000
Tested drive current (mA):	120
Tested case temperature 1 (T _c , °C):	85
Tested case temperature 2 (T _c , °C):	105

Test Data for 85°C Case Temp	
Time (hours)	Lumen Maintenance (%)
0	100.00%
1,000	100.10%
2,000	99.87%
3,000	99.56%
4,000	99.14%
5,000	98.66%
6,000	98.24%
7,000	97.87%
8,000	97.54%
9,000	97.26%
10,000	96.93%
11,000	96.74%
12,000	96.58%

Test Data for 105°C Case Temp	
Time (hours)	Lumen Maintenance (%)
0	100.00%
1,000	99.68%
2,000	99.35%
3,000	98.90%
4,000	98.37%
5,000	97.81%
6,000	97.36%
7,000	96.94%
8,000	96.48%
9,000	96.01%
10,000	95.65%
11,000	95.10%
12,000	94.66%

Results	
Time (t) at which to estimate Lumen maintenance (hours):	50,000
Lumen maintenance at time (t) (%):	86.47%
Reported L70 (hours):	>72,000

DLC Product ID

MODEL NUMBER	ID NUMBER
ALF LS230 T2 G1 FSK	S-SM1CON
ALF LS230 T3 G1 FSK	S-IC8M3S
ALF LS230 T4 G1 FSK	S-CNQPL6
ALF LS230 T5 G1 FSK	S-7W51J3
ALF LS450 T2 G1 FSK	S-VGYJNP
ALF LS450 T3 G1 FSK	S-S5L0TG
ALF LS450 T4G1 FSK	S-9ALW8H
ALF LS450 T5 G1 FSK	S-LOG3PV
ALF LS600 T2 G1 FSK	S-4YMH0H
ALF LS600 T3 G1 FSK	S-TG286H
ALF LS600 T4 G1 FSK	S-LD6LP9
ALF LS600 T5 G1 FSK	S-9YDMMJ

NOTE: ID numbers apply regardless of mount, finish color, or power type.